

Operation Guide

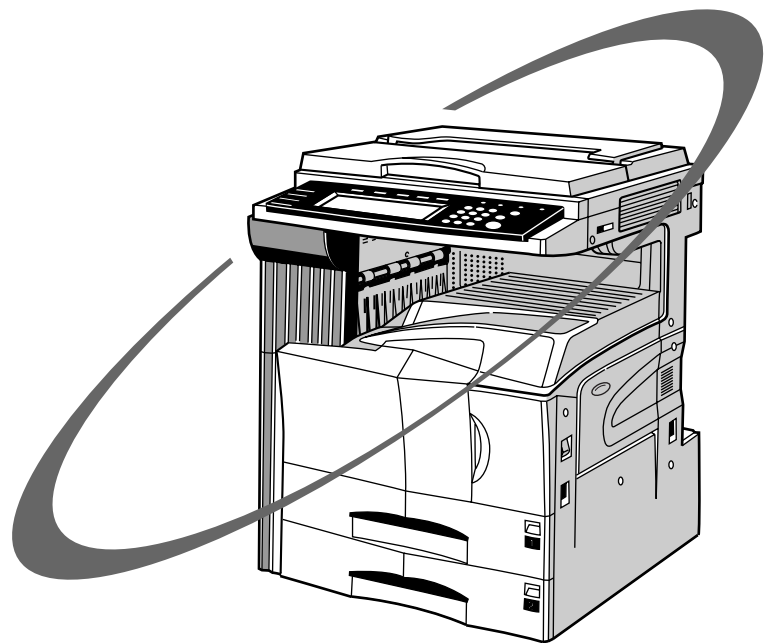

3035

4035

5035

* The above illustration includes the optional original cover.

Please read the Operation Guide before using the copier
Keep it close to the copier for easy reference

<IMPORTANT>

The instructions contained herein are based on the 30 cpm (copies-per-minute) 3035 copier, the 40 cpm 4035 copier and the 50 cpm 5035 copier.

NOTE:

This Operation Guide contains information that corresponds to using both the inch and metric versions of this copier. Within the text we have generally indicated messages by listing that for the inch version followed, in brackets, by the corresponding information for the metric version. However, when a message is essentially the same, or when the difference is only one of upper- and lower-case spelling, we have listed the information specifically as it is displayed in the inch version of this machine.

All rights reserved. No part of this material may be reproduced or transmitted in any form or by any means, electronic or mechanical, including photocopying, recording or by any information storage and retrieval system, without permission in writing from the Publisher.

Legal Restriction On Copying

- It may be prohibited to copy copyrighted material without permission of the copyright owner.
- It is prohibited under any circumstances to copy domestic or foreign currencies.
- Copying other items may be prohibited.

Introduction to this Operation Guide

The explanations contained in this Operation Guide have been separated into different sections in order to allow even those using a copier for the first time to use this machine efficiently, properly and with relative ease.

A basic introduction to each section can be found below for reference. Refer to the related section when using this copier.

Section 1 IMPORTANT! PLEASE READ FIRST.

This section contains explanations on information that is necessary for you to know prior to using this copier for the first time after purchase.

For example, it contains notes and cautions on installation and operation that should be strictly obeyed in order to ensure its safe and proper operation.

Section 2 NAMES OF PARTS

This section contains explanations on the names and functions of the parts of the copier and its operation panel.

Section 3 PREPARATIONS

This section contains explanations on procedures for loading copy paper.

Section 4 BASIC OPERATION

This section contains explanations on the basic procedures required to make simple copies.

Section 5 OTHER CONVENIENT FUNCTIONS

This section contains explanations on using the various convenient functions of this copier.

Section 6 DOCUMENT AND OUTPUT MANAGEMENT FUNCTIONS

This section contains explanations on the procedures for registering frequently used business forms and documents on the optional Hard Disk, printing them out when desired, and managing printing conditions.

Section 7 COPIER MANAGEMENT

This section contains explanations on the procedures for changing the various default settings available for adjusting the copier to fit your copy needs and on the procedures for managing copy us.

Section 8 OPTIONAL EQUIPMENT

This section contains explanations on the optional equipment that are available for use with this copier.

Section 9 TROUBLESHOOTING

This section contains explanations on handling problems that may occur during operation of this copier, such as when an error indication appears or if a paper jam occurs.

Section 10 MAINTENANCE AND OPERATION INFORMATION

This section contains explanations on maintaining the copier in proper condition and on replacing the toner container, as well as information on the specifications for this copier.

CONTENTS

Section 1

IMPORTANT! PLEASE READ FIRST. .. 1-1

- ⚠ CAUTION LABELS 1-1
- ⚠ INSTALLATION PRECAUTIONS 1-2
- ⚠ PRECAUTIONS FOR USE 1-3

Section 2

NAMES OF PARTS 2-1

- 1. Main body 2-1
- 2. Operation panel 2-3
- 3. Touch panel 2-5

Section 3

PREPARATIONS 3-1

- 1. Loading paper 3-1
 - (1) Note when adding paper 3-1
 - (2) Loading paper into the drawer[cassette] 3-2
 - (3) Loading paper into the multi-bypass tray 3-3

Section 4

BASIC OPERATION 4-1

- 1. Basic copying procedure 4-1
- 2. Enlarging/reducing the copy image 4-5
 - (1) Auto magnification selection mode 4-5
 - (2) Zoom mode 4-6
 - (3) Preset zoom mode 4-7
 - (4) XY zoom mode 4-8
- 3. Interrupt copying 4-9
- 4. Job reservation 4-10
- 5. Energy-saving modes 4-11

Section 5

OTHER CONVENIENT FUNCTIONS 5-1

- 1. Making 2-sided copies from various types of originals [2-sided copy modes] 5-1
 - (1) Making 2-sided copies from a 2-sided original 5-1
 - (2) Making 2-sided copies from an open-faced (books, etc.) original 5-1
 - (3) Making 2-sided copies from one-sided originals 5-2
- 2. Copying two-page originals onto separate sheets [Page separation/Split copy modes] 5-4
 - (1) Page separation/Split copy from book originals 5-4
 - (2) Page separation/Split copy from 2-sided originals 5-4
- 3. Making a margin space on the copies [Margin mode] 5-6
 - (1) Standard margin 5-6
 - (2) Separate front and back margin settings 5-6
- 4. Centering the copy image [Centering/Image shift mode] 5-8

- 5. Adding a space next to the copy images for making notes [Memo mode] 5-9
- 6. Making copies with clean edges [Border erase modes] 5-11
 - (1) Erasing blemishes from edges of copies (Sheet erase mode) 5-11
 - (2) Erasing blemishes from the edges and middle of copies made from books (Book erase mode) 5-11
 - (3) Erasing blemishes from the edges of copies using individual border settings (Individual border erase mode) 5-12
- 7. Fitting the image of either two or four originals onto a single copy page [Combine/Merge Copy modes] 5-13
 - (1) 2 in 1 5-13
 - (2) 4 in 1 5-13
- 8. Printing page numbers on copies [Print page numbers mode] 5-16
- 9. Overlaying one image over another [Form overlay mode] 5-20
- 10. Making booklets from sheet originals [Booklet/Stitching mode] 5-22
- 11. Making booklets from book originals [Book to Booklet mode] 5-26
- 12. Automatic sorting of copy sets without the Document Finisher [Sort/Finished mode] 5-29
- 13. Auto rotation function 5-30
- 14. Adding a front and/or back cover to your copy sets [Cover mode] 5-31
- 15. Original size selection mode 5-34
- 16. Feeding paper as a backing sheet for OHP transparencies [Transparency + backing sheet mode] 5-36
- 17. Inverting black and white [Invert mode] 5-38
- 18. Making mirror image copies [Mirror image mode] 5-39
- 19. Making a test copy prior to large volume copying [Proof mode] 5-40
- 20. Making more of the same copies after a copy job is finished [Repeat copy mode] 5-42
 - (1) Registering a copy job for repeat copying 5-42
 - (2) Printing out with the repeat copy mode 5-43
- 21. Copying a large volume of originals in one operation [Batch scanning mode] 5-47
- 22. Saving on toner use [Eco print mode] 5-48
- 23. Original set direction 5-49
- 24. Memorizing frequently used settings [Program function] 5-50
 - (1) Registering a program 5-50
 - (2) Using programmed settings to make copies 5-51
 - (3) Changing a registered program name 5-51
 - (4) Deleting a registered program 5-52
- 25. Registration keys 5-53
 - (1) Registering a function or mode under a function key 5-53
 - (2) Deleting a registration key 5-55
- 26. Easily add covers and insert sheets between various sets of originals in one operation [Job build mode] 5-57
 - (1) Using the job build mode 5-57
 - (2) Selecting the settings and functions 5-62

Section 6
DOCUMENT AND OUTPUT
MANAGEMENT FUNCTIONS 6-1

- 1. Document management functions 6-1
 - (1) What are the “document management” functions? 6-1
 - (2) Form registration 6-1
 - (3) Shared data box 6-4
 - (4) Synergy print boxes 6-9
- 2. Output management functions 6-20
 - (1) What are the “output management” functions? 6-20
 - (2) Display of the output management functions 6-21
 - (3) The “Print status” screen 6-22

Section 7
COPIER MANAGEMENT FUNCTIONS 7-1

- 1. Copy management mode 7-1
 - (1) Copy management procedures 7-2
 - (2) Accessing the copy management menu screen 7-3
 - (3) Editing copy management information 7-4
 - (4) Checking the copy management counts 7-21
 - (5) Turning the copy management function ON/OFF 7-25
 - (6) Changing the copy management default settings 7-25
 - (7) Making copies when copy management is turned ON .. 7-37
- 2. Default settings 7-38
 - (1) Machine default settings 7-38
 - (2) Accessing the machine default settings 7-41
 - (3) Making machine default settings 7-42
 - (4) Copy default settings 7-59
 - (5) Accessing the copy default settings 7-62
 - (6) Making copy default settings 7-63
- 3. Multi-bypass tray paper settings 7-87
 - (1) Paper size and type 7-87
 - (2) Selecting other standard sizes 7-88
- 4. Original size registration 7-90
- 5. Drum refresh 7-91
- 6. Checking the total counter and printing out the counter report 7-93
- 7. Box management default settings 7-94
 - (1) Box settings 7-94
 - (2) Accessing the box management default settings 7-94
 - (3) Making box management default settings 7-95
- 8. Hard disk management 7-99
- 9. Report print out 7-101
- 10. Changing the language used for messages 7-103
- 11. Entering characters 7-104
 - (1) Character input screens 7-104
 - (2) Character input procedure 7-106

Section 8
OPTIONAL EQUIPMENT 8-1

- (1) Document Processor 8-1
- (2) Paper Feeder 8-5
- (3) Paper Feeder 8-5
- (4) Document Finisher 8-5
- (5) Document Finisher 8-9
- (6) Document Finisher 8-9
- (7) Built-in Finisher 8-9
- (8) Job Separator 8-11
- (9) Hard Disk 8-11
- (10) Key Counter 8-12
- (11) Document Tray 8-12
- (12) Printer Kit 8-12
- (13) Printer/Scanner Kit 8-12
- (14) Fax Kit 8-12

Section 9
TROUBLESHOOTING 9-1

- 1. If one of the following messages is displayed 9-1
- 2. If one of these indicators lights or flashes 9-3
- 3. When paper misfeeds 9-4
 - (1) Cautions 9-4
 - (2) Removal procedures 9-4
- 4. If other trouble occurs 9-13

Section 10
MAINTENANCE AND OPERATION
INFORMATION 10-1

- 1. Cleaning the copier 10-1
- 2. Replacing the toner container and waste toner box 10-3
- 3. Specifications 10-7
- 4. Environmental Specifications 10-9
- 5. Installing the optional equipment 10-10
- Appendix: Functions and settings combination chart 10-12

● MAKING FULL USE OF THE COPIER'S ADVANCED FUNCTIONS

- 1** Having the copier automatically select copy paper of the same size as the original
<Auto paper selection mode>
 (Page 4-2)

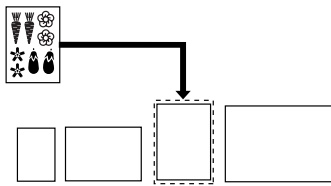

- 2** Making clear reproductions of photographs
<Image quality selection>
 (Page 4-3)

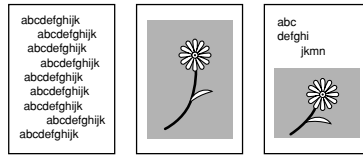

- 3** Various functions for making enlarged and reduced copies
 ■ Enlarging/reducing the copy image to fit the size of paper in a specified drawer[cassette]
<Auto magnification selection mode>
 (Page 4-5)

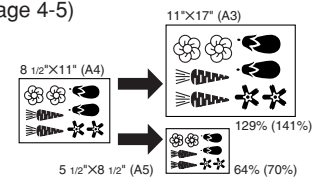

- Enlarging/reducing the copy image to a desired size between 25% and 400%
<Zoom mode> (Page 4-6)

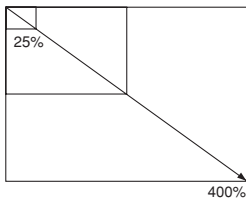

- One-touch selection of the copy magnification ratio
<Preset zoom mode>
 (Page 4-7)

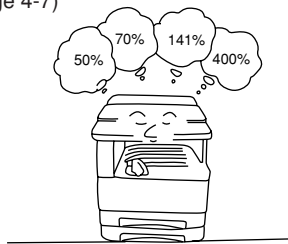

- Enlarging/reducing the length and width of the image to separate magnification ratios
<XY zoom mode>
 (Page 4-8)

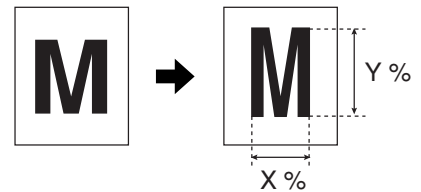

- 4** Making 2-sided copies from various types of originals
<2-sided copy modes>
 (Page 5-1)

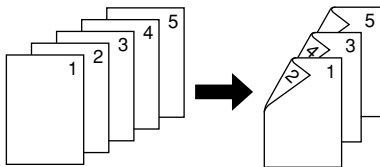

- 5** Copying each image of open-faced (books, etc.) or 2-sided originals onto separate sheets
<Page separation/Split copy modes>
 (Page 5-4)

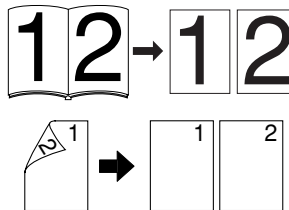

- 6** Creating a margin on the copies
<Margin mode>
 (Page 5-6)

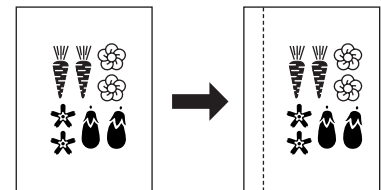

- 7** Centering the copy image
<Centering/Image shift mode>
 (Page 5-8)

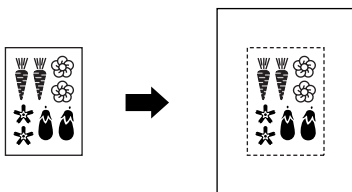

- 8** Adding a space next to the copy images for making notes
<Memo mode>
 (Page 5-9)

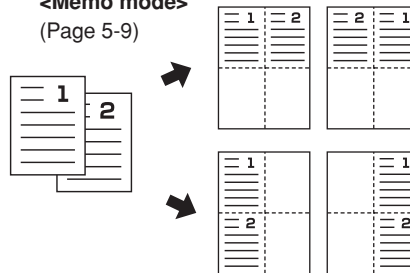

- 9** Making copies with clean edges
<Border erase modes>
 (Page 5-11)

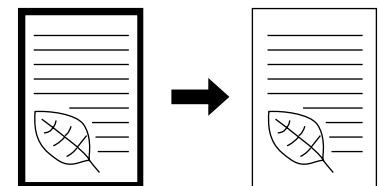

- 10** Fitting the image of either two or four originals onto a single copy page
<Combine/Merge Copy modes>
 (Page 5-13)

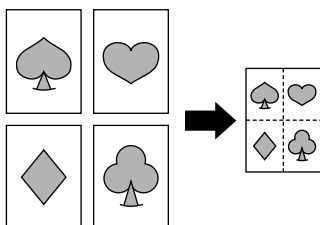

- 11** Printing page numbers on the copies
<Print page numbers mode>
 (Page 5-16)

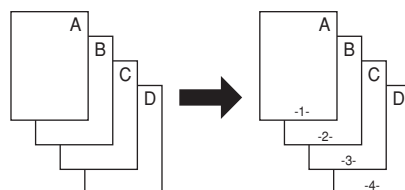

- 12** Overlaying one image over another
<Form overlay mode>
 (Page 5-20)

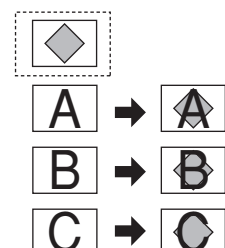

13 Making booklets from sheet originals
<Booklet/Stitching mode>
 (Page 5-22)

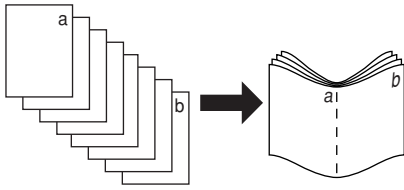

14 Making booklets from books
<Book to Booklet mode>
 (Page 5-26)

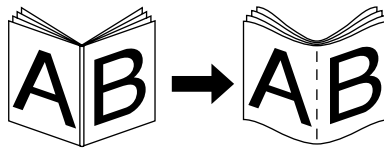

15 Automatic sorting of copy sets without the Document Finisher
<Sort/Finished mode>
 (Page 5-29)

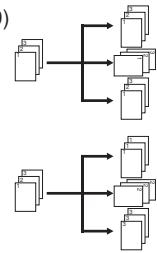

16 Automatic rotation of the copy image
<Auto rotation function>
 (Page 5-30)

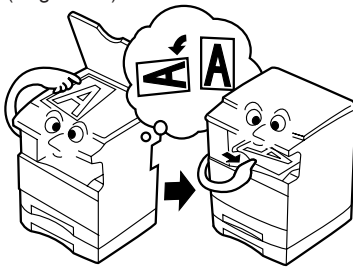

17 Adding a front and/or back cover to your copy sets
<Cover mode>
 (Page 5-31)

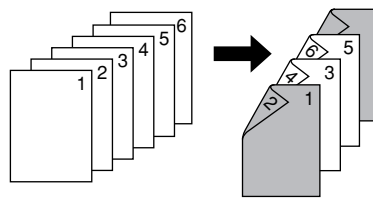

18 Feeding paper as a backing sheet for OHP transparencies
<Transparency + backing sheet mode>
 (Page 5-36)

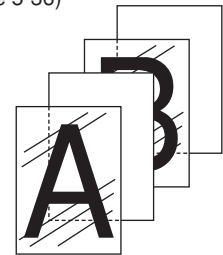

19 Inverting black and white
<Invert mode>
 (Page 5-38)

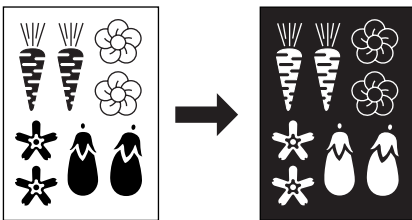

20 Making mirror image copies
<Mirror image mode>
 (Page 5-39)

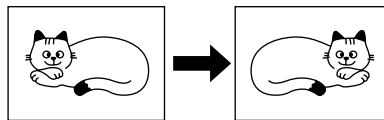

21 Making a test copy prior to large volume copying
<Proof mode>
 (Page 5-40)

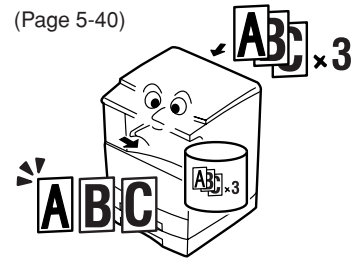

22 Making more of the same copies after a copy job is finished
<Repeat copy mode>
 (Page 5-42)

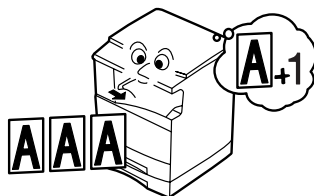

23 Copying a large volume of originals in one operation
<Batch scanning mode>
 (Page 5-47)

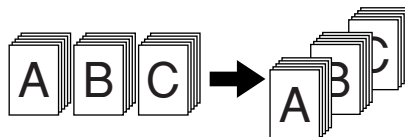

24 Saving on toner use
<Eco print mode>
 (Page 5-48)

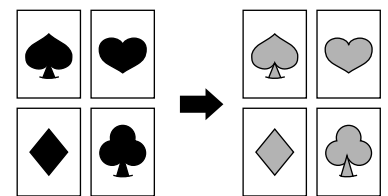

25 Memorizing frequently used settings
<Program function>
 (Page 5-50)

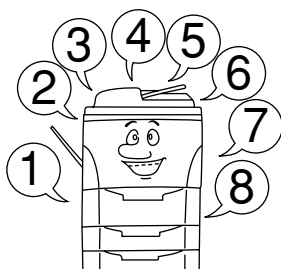

26 Easily add covers and insert sheets between various sets of originals in one operation
<Job build mode>
 (Page 5-57)

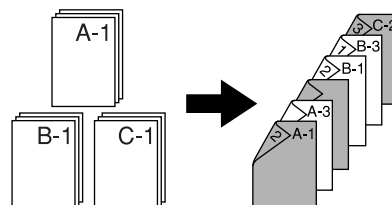

27 Registering images to be used for form overlay
<Form registration>
 (Page 6-1)

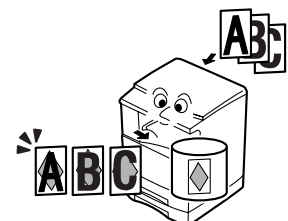

28 Managing shared forms
<Shared data box>
 (Page 6-4)

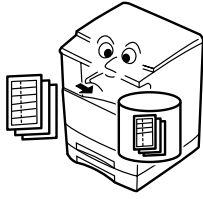

29 Printing out different stored originals in one operation
<Synergy print boxes>
 (Page 6-9)

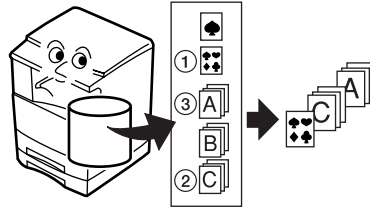

30 Using department ID-codes to manage the number of copies made by each department
<Copy management mode>
 (Page 7-1)



31 Changing the language used in the touch panel
<Language selection function>
 (Page 7-103)

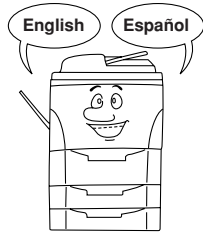

32 A full range of optional equipment is available
 ■ Document Processor (Page 8-1)

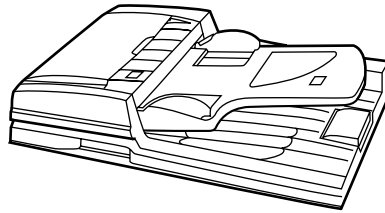

■ Paper Feeder (Page 8-5)

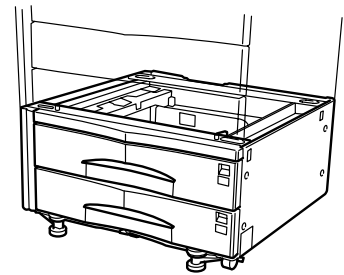

■ Paper Feeder (Page 8-5)

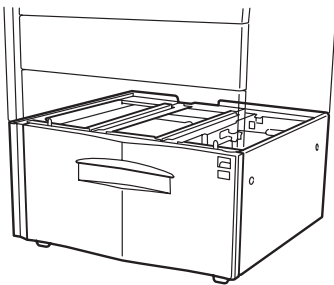

■ Document Finisher (Page 8-5)

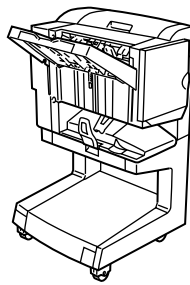

■ Document Finisher (Page 8-9)

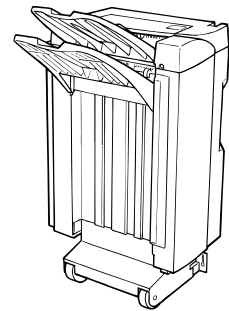

■ Document Finisher (Page 8-9)

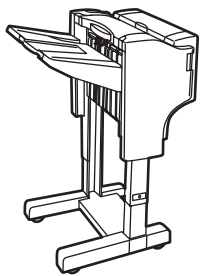

■ Built-in Finisher (Page 8-9)

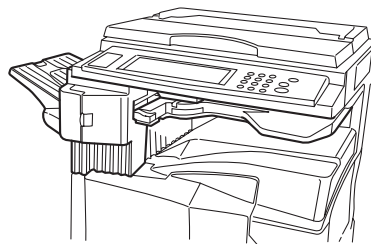

■ Job Separator (Page 8-11)

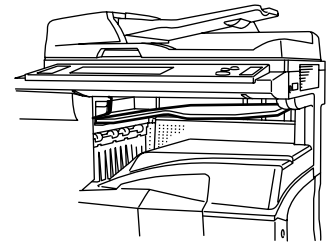

■ Hard Disk (Page 8-11)

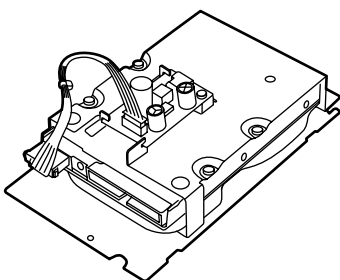

■ Key Counter (Page 8-12)

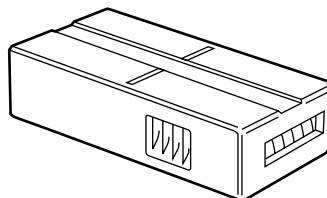

■ Document Tray (Page 8-12)

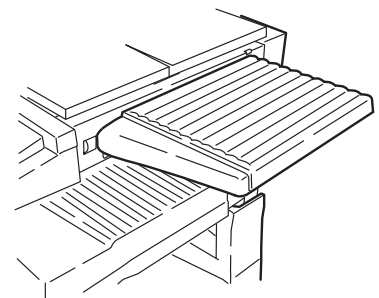

■ Printer Kit (Page 8-12)

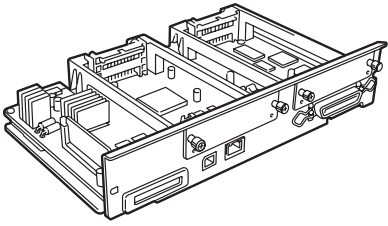

■ Printer/scanner Kit (Page 8-12)

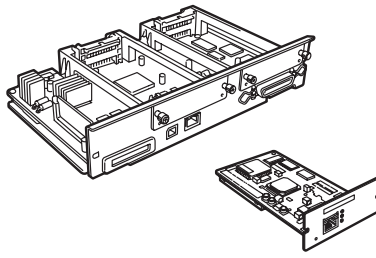

■ Fax Kit (Page 8-12)

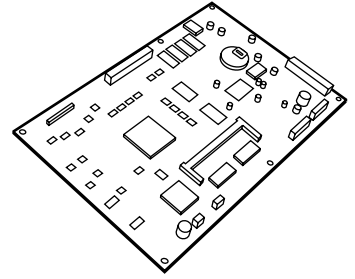



We have determined as a participating company in the International Energy Star Program that this product is compliant with the standards laid out in the International Energy Star Program.

About the International Energy Star Program

International Energy Star Program has as its basic goals the promotion of efficient energy use and the reduction of the environmental pollution that accompanies energy consumption by promoting the manufacture and sale of products that fulfill program standards.

International Energy Star Program standards require that copies come equipped with a "Low Power Mode" where energy consumption is reduced after a certain amount of time elapses since the device was last used, as well as an "Off Mode" where the device automatically turns itself off after there is no activity within a set amount of time. When the copier includes printer and fax functions, the printer and fax must enter a "Low Power Mode" where power consumption is automatically reduced after a certain amount of time elapses since they were last used, and they must also support a "Sleep Mode" where power consumption is reduced to a minimum when there is no activity within a set amount of time. This product is equipped with the following features as a result of its compliance with International Energy Star Program standards.

● Low Power Mode

The device automatically enters "Low Power Mode" when 15 minutes have passed since the device was last used. The amount of time of no activity that must pass before "Low Power Mode" is activated may be lengthened. See "5. Energy-saving modes" on page 4-11 and "Auto low power time" on page 7-48 for more information.

● Off Mode (Only when using the copier functions of this machine)

The device automatically enters "Off Mode" when 60 minutes have passed since the device was last used. The amount of time of no activity that must pass before "Off Mode" is activated may be lengthened. For more information see "5. Energy-saving modes" on page 4-11 and "Auto sleep time" on page 7-47.

● Sleep Mode (If the copier has printer and/or facsimile function)

The device automatically enters "Sleep Mode" when 60 minutes have passed since the device was last used. The amount of time of no activity that must pass before "Sleep Mode" is activated may be lengthened. For more information see "5. Energy-saving modes" on page 4-11 and "Auto sleep time" on page 7-47.

● Automatic 2-Sided Copy Function

The Energy Star Program encourages the use of 2-sided copying which reduces the load on the environment and this device includes 2-sided copying as a standard function. For example, by copying two 1-sided originals onto a single sheet of paper as a 2-sided copy, it is possible to lower the amount of paper used. For more information see "1. Making 2-sided copies from various types of originals [2-sided copy modes]" on page 5-1.

● Paper Recycling

The Energy Star Program encourages the use of environmentally friendly recycled paper. Your sales or service representative can provide information about recommended paper types.

* When you are using the copier functions of this machine, replace all references to the "Sleep Mode" with the "Off Mode".

Please read this Operation Guide before using the copier. Keep it close to the copier for easy reference.

The sections of this guide and parts of the copier marked with symbols are safety warnings meant to protect the user, other individuals and surrounding objects, and ensure correct and safe usage of the copier. The symbols and their meanings are indicated below.



DANGER: Indicates that serious injury or even death will very possibly result from insufficient attention to or incorrect compliance with the related points.



WARNING: Indicates that serious injury or even death may result from insufficient attention to or incorrect compliance with the related points.



CAUTION: Indicates that personal injury or mechanical damage may result from insufficient attention to or incorrect compliance with the related points.

Symbols

The \triangle symbol indicates that the related section includes safety warnings. Specific points of attention are indicated inside the symbol.



..... [General warning]



..... [Warning of danger of electrical shock]



..... [Warning of high temperature]

The \odot symbol indicates that the related section includes information on prohibited actions. Specifics of the prohibited action are indicated inside the symbol.



..... [Warning of prohibited action]



..... [Disassembly prohibited]

The \bullet symbol indicates that the related section includes information on actions which must be performed. Specifics of the required action are indicated inside the symbol.



..... [Alert of required action]



..... [Remove the power plug from the outlet]



..... [Always connect the copier to an outlet with a ground connection]

Please contact your service representative to order a replacement if the safety warnings in this Operation Guide are illegible or if the guide itself is missing. (fee required)

Section 1 IMPORTANT! PLEASE READ FIRST.

CAUTION LABELS

Caution labels have been attached to the copier at the following locations for safety purposes.
BE SUFFICIENTLY CAREFUL to avoid fire or electric shock when removing a paper jam or when replacing toner.

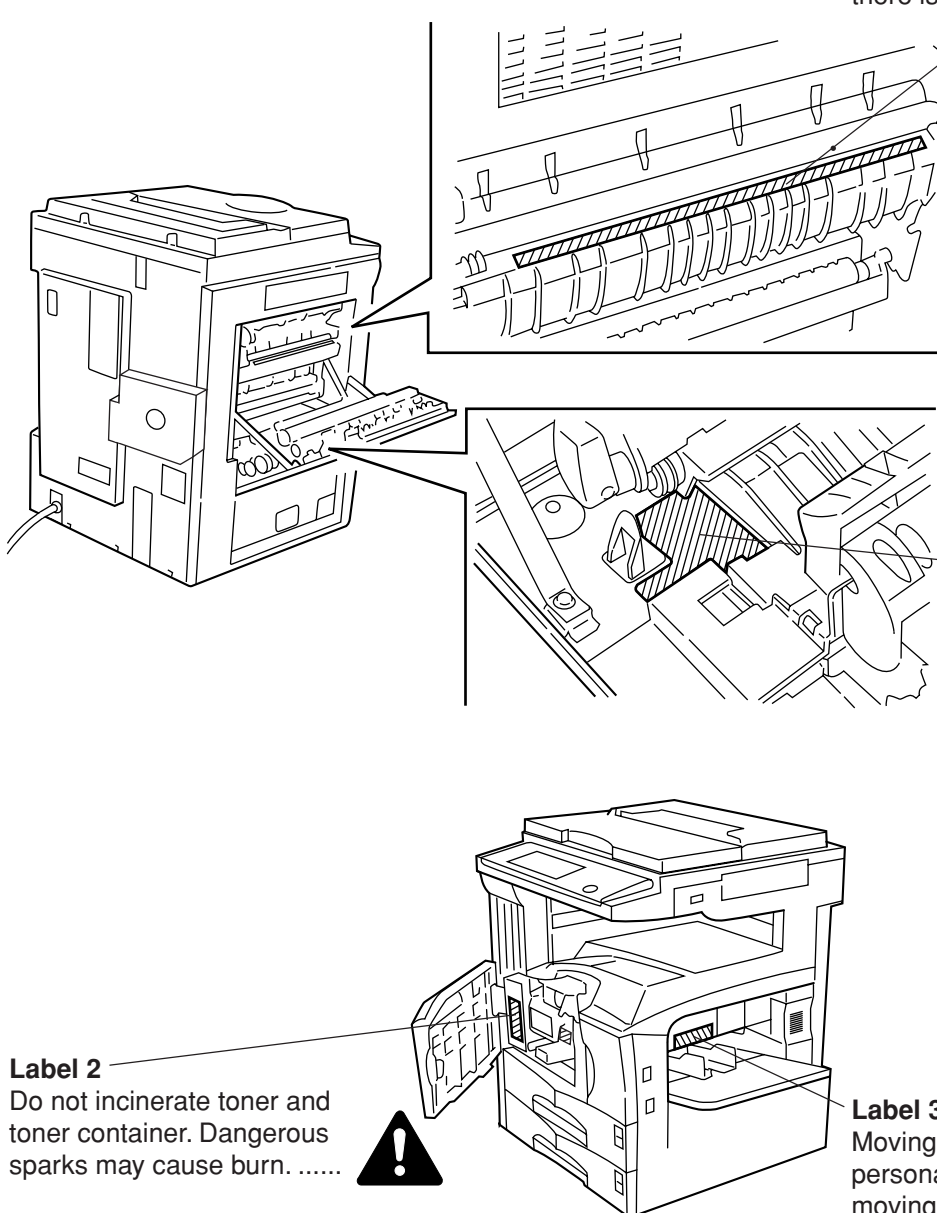

Label 1
High temperature inside. Do not touch parts in this area, because there is a danger of getting burned. 

Label 2
Do not incinerate toner and toner container. Dangerous sparks may cause burn. 

Label 3
Moving parts inside. May cause personal injury. Do not touch moving parts. 





Label 4
High temperature inside. Do not touch parts in this area, because there is a danger of getting burned. 

NOTE: DO NOT remove these labels.

INSTALLATION PRECAUTIONS

■ Environment

CAUTION

- Avoid placing the copier on or in locations which are unstable or not level. Such locations may cause the copier to fall down or fall over. This type of situation presents a danger of personal injury or damage to the copier. 
- Avoid locations with humidity or dust and dirt. If dust or dirt become attached to the power plug, clean the plug to avoid the danger of fire or electrical shock. 
- Avoid locations near radiators, heaters, or other heat sources, or locations near flammable items, to avoid the danger of fire. 
- To keep the copier cool and facilitate changing of parts and maintenance, allow access space as shown below. Leave adequate space, especially around the vents, to allow air to be properly ventilated out of the copier. 

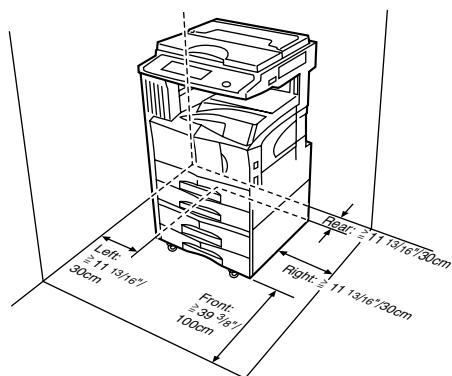



Other precautions

- Adverse environmental conditions may affect the safe operation and performance of the copier. Install in an air-conditioned room (recommended room temperature: around 73.4°F (23°C), humidity: around 50%) and avoid the following locations when selecting a site for the copier.
 - Avoid locations near a window or with exposure to direct sunlight.
 - Avoid locations with vibrations.
 - Avoid locations with drastic temperature fluctuations.
 - Avoid locations with direct exposure to hot or cold air.
 - Avoid poorly ventilated locations.
- Delicate floor material may be damaged if this product is moved after installation.

- During copying, some ozone is released, but the amount does not cause any ill effect to one's health. If, however, the copier is used over a long period of time in a poorly ventilated room or when making an extremely large number of copies, the smell may become unpleasant. To maintain the appropriate environment for copy work, it is suggested that the room be properly ventilated.

■ Power supply/Grounding the copier

WARNING

- DO NOT use a power supply with a voltage other than that specified. Avoid multiple connections in the same outlet. These types of situations present a danger of fire or electrical shock. 
- Plug the power cord securely into the outlet. If metallic objects come in contact with the prongs on the plug, it may cause a fire or electric shock. 
- Always connect the copier to an outlet with a ground connection to avoid the danger of fire or electrical shock in case of an electric short. If an earth connection is not possible, contact your service representative. 

Other precautions

- Connect the power plug to the closest outlet possible to the copier.
- The power supply cord is used as the main disconnect device. Ensure that the socket/outlet is located/installed near the equipment and is easily accessible.

■ Handling of plastic bags









WARNING

- Keep the plastic bags that are used with the copier away from children. The plastic may cling to their nose and mouth causing suffocation. 







PRECAUTIONS FOR USE

■ Cautions when using the copier

WARNING

- DO NOT place metallic objects or containers with water (flower vases, flower pots, cups, etc.) on or near the copier. This of situation presents a danger of fire or electrical shock should they fall inside. 
- DO NOT remove any of the covers from the copier as there is a danger of electrical shock from high voltage parts inside the copier. 
- DO NOT damage, break or attempt to repair the power cord. DO NOT place heavy objects on the cord, pull it, bend it unnecessarily or cause any other type of damage. These types of situations present a danger of fire or electrical shock. 
- NEVER attempt to repair or disassemble the copier or its parts as there is a danger of fire, electrical shock or damage to the laser. If the laser beam escapes, there is a danger of it causing blindness. 
- If the copier becomes excessively hot, smoke appears from the copier, there is an odd smell, or any other abnormal situation occurs, there is a danger of fire or electrical shock. Turn the power switch OFF (O) immediately, BE ABSOLUTELY CERTAIN to remove the power plug from the outlet and then contact your service representative. 
- If anything harmful (paper clips, water, other fluids, etc.) falls into the copier, turn the power switch OFF (O) immediately. Next, BE ABSOLUTELY CERTAIN to remove the power plug from the outlet to avoid the danger of fire or electrical shock. Then contact your service representative. 
- DO NOT remove or connect the power plug with wet hands, as there is a danger of electrical shock. 
- ALWAYS contact your service representative for maintenance or repair of internal parts. 

CAUTION

- DO NOT pull the power cord when removing it from the outlet. If the power cord is pulled, the wires may become broken and there is a danger of fire or electrical shock. (ALWAYS grasp the power plug when removing the power cord from the outlet.) 
- ALWAYS remove the power plug from the outlet when moving the copier. If the power cord is damaged, there is a danger of fire or electrical shock. 
- If the copier will not be used for a short period of time (overnight, etc.), turn the power switch OFF (O). If it will not be used for an extended period of time (vacations, etc.), remove the power plug from the outlet for safety purposes during the time the copier is not in use. 
- ALWAYS hold the designated parts only when lifting or moving the copier. 
- For safety purposes, ALWAYS remove the power plug from the outlet when performing cleaning operations. 
- If dust accumulates within the copier, there is a danger of fire or other trouble. It is therefore recommended that you consult with your service representative in regard to cleaning of internal parts. This is particularly effective if accomplished prior to seasons of high humidity. Consult with your service representative in regard to the cost of cleaning the internal parts of the copier. 





PRECAUTIONS FOR USE

Other precautions

- DO NOT place heavy objects on the copier or cause other damage to the copier.
- DO NOT open the front cover, turn off the power switch, or pull out the power plug during copying.
- When lifting or moving the copier, contact your service representative.
- Do not touch electrical parts, such as connectors or printed circuit boards. They could be damaged by static electricity.
- DO NOT attempt to perform any operations not explained in this handbook.
- CAUTION : Use of controls or adjustments or performance of procedures other than those specified herein may result in hazardous radiation exposure.
- Do not look directly at the light from the scanning lamp as it may cause your eyes to feel tired or painful.

■ Cautions when handling consumables

CAUTION

- DO NOT attempt to incinerate the toner container or the waste toner box. Dangerous sparks may cause burns. 
- Keep the toner container and the waste toner box out of the reach of children. 
- If toner happens to spill from the toner container or the waste toner box, avoid inhalation and ingestion, as well as contact with your eyes and skin. 
 - If you do happen to inhale toner, move to a place with fresh air and gargle thoroughly with a large amount of water. If coughing develops, contact a physician.
 - If you do happen to ingest toner, rinse your mouth out with water and drink 1 or 2 cups of water to dilute the contents of your stomach. If necessary, contact a physician.
 - If you do happen to get toner in your eyes, flush them thoroughly with water. If there is any remaining tenderness, contact a physician.
 - If toner does happen to get on your skin, wash with soap and water.
- DO NOT attempt to force open or destroy the toner container or the waste toner box. 

Other precautions

- After use, ALWAYS dispose of the toner container and the waste toner box in accordance with Federal, State and Local rules and regulations.
- Store all consumables in a cool, dark location.
- If you will not be using the copier for a prolonged period of time, remove all paper from the drawer(s)[cassette(s)] and the multi-bypass tray and seal in its original packaging.

SAFETY OF LASER BEAM

1. Safety of laser beam

This copier has been certified by the manufacturer to Class 1 level under the radiation performance standards established by the U.S. DHHS (Department of Health and Human Services) in 1968. This indicates that the product is safe to use during normal operation and maintenance. The laser optical system, enclosed in a protective housing and sealed within the external covers, never permits the laser beam to escape.

2. The CDRH Act

A laser-product-related act was implemented on Aug. 2, 1976, by the Center for Devices and Radiological Health (CDRH) of the U.S. Food and Drug Administration (FDA). This act prohibits the sale of laser products in the U.S. without certification, and applies to laser products manufactured after Aug. 1, 1976.

The label shown below indicates compliance with the CDRH regulations and must be attached to laser products marketed in the United States.

On this copier, the label is on the right side.

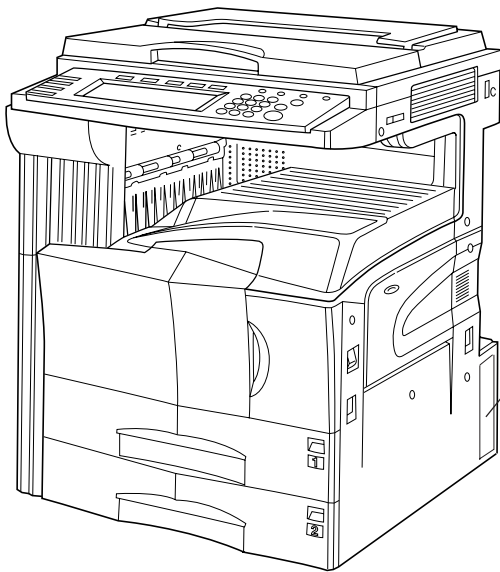

| |
|---|
| 3035 |
| COPYING MACHINE 120V~ 60Hz 12A MACHINE No. AJK3 MANUFACTURED |
| Tested To Comply With FCC Standards FOR HOME OR OFFICE USE 3 3 T 1 US C11 |
| LISTED I.T.E. |
| This device complies with Part 15 of the FCC Rules. Operation is subject to the following two conditions: (1) This device may not cause harmful interference, and (2) this device must accept any interference received, including interference that may cause undesired operation. |
| This Class B digital apparatus complies with Canadian ICES-003. Cet appareil numérique de la classe B est conforme à la norme NMB-003 du Canada. |
| THIS PRODUCT COMPLIES WITH 21 CFR CHAPTER 1, SUBCHAPTER J. |
| C11 |
| KYOCERA MITA CORPORATION 2-28 1-CHOME TAMATSUKURI CHUO-KU OSAKA JAPAN MADE IN CHINA >PS< |

| |
|---|
| 4035 |
| COPYING MACHINE 120V~ 60Hz 12A MACHINE No. AJL3 MANUFACTURED |
| Tested To Comply With FCC Standards FOR HOME OR OFFICE USE 3 3 T 1 US C11 |
| LISTED I.T.E. |
| This device complies with Part 15 of the FCC Rules. Operation is subject to the following two conditions: (1) This device may not cause harmful interference, and (2) this device must accept any interference received, including interference that may cause undesired operation. |
| This Class B digital apparatus complies with Canadian ICES-003. Cet appareil numérique de la classe B est conforme à la norme NMB-003 du Canada. |
| THIS PRODUCT COMPLIES WITH 21 CFR CHAPTER 1, SUBCHAPTER J. |
| C11 |
| KYOCERA MITA CORPORATION 2-28 1-CHOME TAMATSUKURI CHUO-KU OSAKA JAPAN MADE IN CHINA >PS< |

| |
|---|
| 5035 |
| COPYING MACHINE 120V~ 60Hz 12A MACHINE No. AJM3 MANUFACTURED |
| Tested To Comply With FCC Standards FOR HOME OR OFFICE USE 3 3 T 1 US C11 |
| LISTED I.T.E. |
| This device complies with Part 15 of the FCC Rules. Operation is subject to the following two conditions: (1) This device may not cause harmful interference, and (2) this device must accept any interference received, including interference that may cause undesired operation. |
| This Class B digital apparatus complies with Canadian ICES-003. Cet appareil numérique de la classe B est conforme à la norme NMB-003 du Canada. |
| THIS PRODUCT COMPLIES WITH 21 CFR CHAPTER 1, SUBCHAPTER J. |
| C11 |
| KYOCERA MITA CORPORATION 2-28 1-CHOME TAMATSUKURI CHUO-KU OSAKA JAPAN MADE IN CHINA >PS< |

3. Optical unit

When checking the optical unit, avoid direct exposure to the laser beam, which is invisible.

Shown below is the label located on the cover of the optical unit.

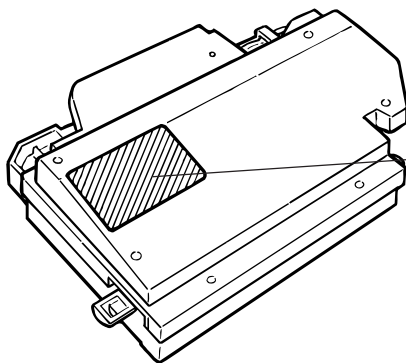

| | |
|---|---|
| DANGER | INVISIBLE LASER RADIATION WHEN OPEN. AVOIDO DIRECT EXPOSURE TO BEAM. |
| CAUTION | INVISIBLE LASER RADIATION WHEN OPEN. AVOID EXPOSURE TO BEAM. |
| ATTENTION | RAYONNEMENT LASER INVISIBLE SI OUVERT. DANGEREUX DE REGARDER A L'INTERIEUR. |
| VORSICHT | UNSICHTBARE LASERSTRAHLEN WENN GEÖFFNET. NICHT HINENSEHEN. |
| TYPE:2AV1301 MATSUSHITA WAVE LENGHT:770-795nm LASER SOURCE:5mW INPUT:24VDC/MAX2.0A 5VDC/300mA | |
| | |

4. Maintenance

For safety of the service personnel, follow the maintenance instructions in the other section of this manual.

5. Safety switch

The power to the laser unit is cut off when the front cover is opened.

CAUTION!

The power plug is the main isolation device! Other switches on the equipment are only functional switches and are not suitable for isolating the equipment from the power source.

ATTENTION!

Le débranchement de la fiche secteur est le seul moyen de mettre l'appareil hors tension. Les interrupteurs sur l'appareil ne sont que des interrupteurs de fonctionnement : ils ne mettent pas l'appareil hors tension.

NEW 3035/4035/5035 COPIER LIMITED WARRANTY

1. Kyocera Mita America, Inc. and Kyocera Mita Canada, Ltd. (both referred to as "Kyocera Mita") warrant the Customer's new copier, and the new accessories installed with the initial installation of the copier, against any defects in material and workmanship for a period of one year, or 400,000 copies/prints from date of installation by an Authorized Kyocera Mita Dealer for the 3035, or 500,000 copies/prints from date of installation by an Authorized Kyocera Mita Dealer for the 4035 and the 5035, whichever first occurs. In the event the copier or an accessory is found to be defective within the warranty period, Kyocera Mita's only obligation and the Customer's exclusive remedy shall be replacement of any defective parts. It is understood that Kyocera Mita shall have no obligation to furnish labor.
2. This warranty is valid only as to the original retail purchaser (referred to as the "Customer") of a new Kyocera Mita copier in the United States of America, or Canada based upon the country of purchase.
3. In order to obtain performance of this warranty, the Customer must immediately notify the Authorized Kyocera Mita Dealer from whom the product was purchased. If the Kyocera Mita Dealer is not able to provide service, write to Kyocera Mita at the address below for the name and address of the Authorized Kyocera Mita Dealer in your area.
4. This warranty does not cover copiers or accessories: (a) which have become damaged due to operator negligence, misuse, accidents, improper storage or unusual physical or electrical stress, (b) which have used parts or supplies which are not genuine Kyocera Mita brand parts or supplies, (c) which have been serviced by a technician not employed by Kyocera Mita or an Authorized Kyocera Mita Dealer, or (d) which have had the serial number modified, altered, or removed.
5. This warranty does not cover Maintenance Kits or the components of Maintenance Kits, which consist of the drum unit, the fixing unit, and the developing unit. Kyocera Mita shall give the Customer a separate warranty for these items.
6. This warranty gives the Customer specific legal rights. The Customer may also have other rights, which vary from state to state, or province to province. Neither the seller, nor any other person is authorized to extend the time period, or expand this warranty on behalf of Kyocera Mita.
7. THIS WARRANTY IS MADE IN LIEU OF ALL OTHER WARRANTIES AND (CONDITIONS), EXPRESS OR IMPLIED, AND KYOCERA MITA SPECIFICALLY DISCLAIMS ANY IMPLIED WARRANTY (OR CONDITION) OF MERCHANTABILITY OR FITNESS FOR A PARTICULAR PURPOSE. THIS WARRANTY SHALL NOT EXTEND TO, AND KYOCERA MITA SHALL NOT BE LIABLE FOR, ANY INCIDENTAL OR CONSEQUENTIAL DAMAGES WHICH MAY ARISE OUT OF THE USE, OR INABILITY TO USE, THE COPIER.

KYOCERA MITA AMERICA, INC.

225 Sand Road
Fairfield, New Jersey
07004-0008, USA

KYOCERA MITA CANADA, LTD.

6120 Kestrel Road
Mississauga, Ontario L5T 1S8
Canada

WARNING

This equipment has been tested and found to comply with the limits for a Class B digital device, pursuant to Part 15 of the FCC Rules. These limits are designed to provide reasonable protection against harmful interference in a residential installation. This equipment generates, uses and can radiate radio frequency energy and, if not installed and used in accordance with the instructions, may cause harmful interference to radio communications. However, there is no guarantee that interference will not occur in a particular installation. If this equipment does cause harmful interference to radio or television reception, which can be determined by turning the equipment off and on, the user is encouraged to try to correct the interference by one or more of the following measures:

- Reorient or relocate the receiving antenna.
- Increase the separation between the equipment and receiver.
- Connect the equipment into an outlet on a circuit different from that to which the receiver is connected.
- Consult the dealer or an experienced radio/TV technician for help.

CAUTION – The changes or modifications not expressly approved by the party responsible for compliance could void the user's authority to operate the equipment.

* The above warning is valid only in the United States of America.

Section 2 NAMES OF PARTS

1. Main body

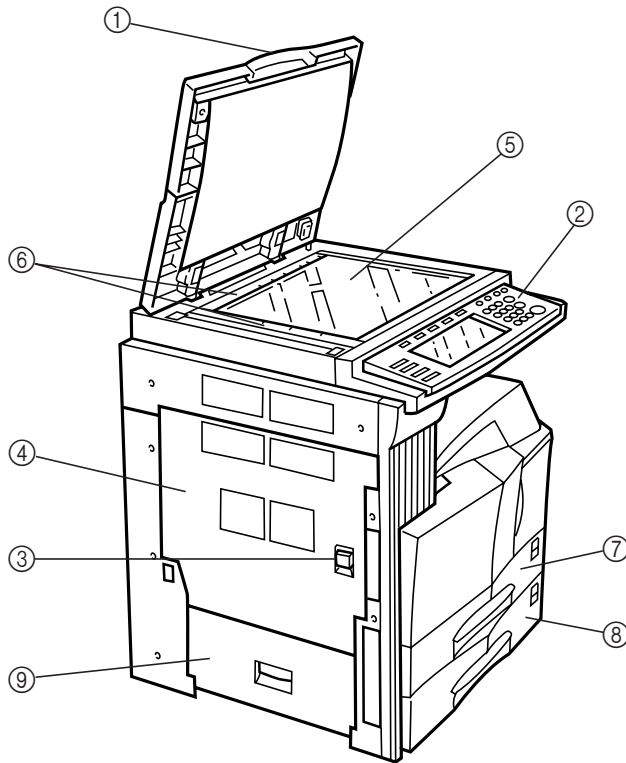

- ① **Original cover (Option)**
(Open/close to set the original on the platen.)
- ② **Operation panel**
(Contains the keys and indicators for operating the copier.)
- ③ **Left cover 1 handle**
(Pull up to open the left cover 1.)
- ④ **Left cover 1**
(Open when a paper misfeed occurs.)
- ⑤ **Platen**
(Set originals here for copying. Place originals face-down with the edges aligned with the size scales on the left and rear sides of the platen.)
- ⑥ **Original size scales**
(Be sure to align the original with these when setting the original on the platen.)
- ⑦ **Drawer[Cassette] 1**
(Holds up to 500 sheets of standard paper [standard paper specified by our company].)
- ⑧ **Drawer[Cassette] 2**
(Holds up to 500 sheets of standard paper [standard paper specified by our company].)
- ⑨ **Left cover 2**
(Open when a paper misfeed occurs inside the left cover 2.)

Section 2 NAMES OF PARTS

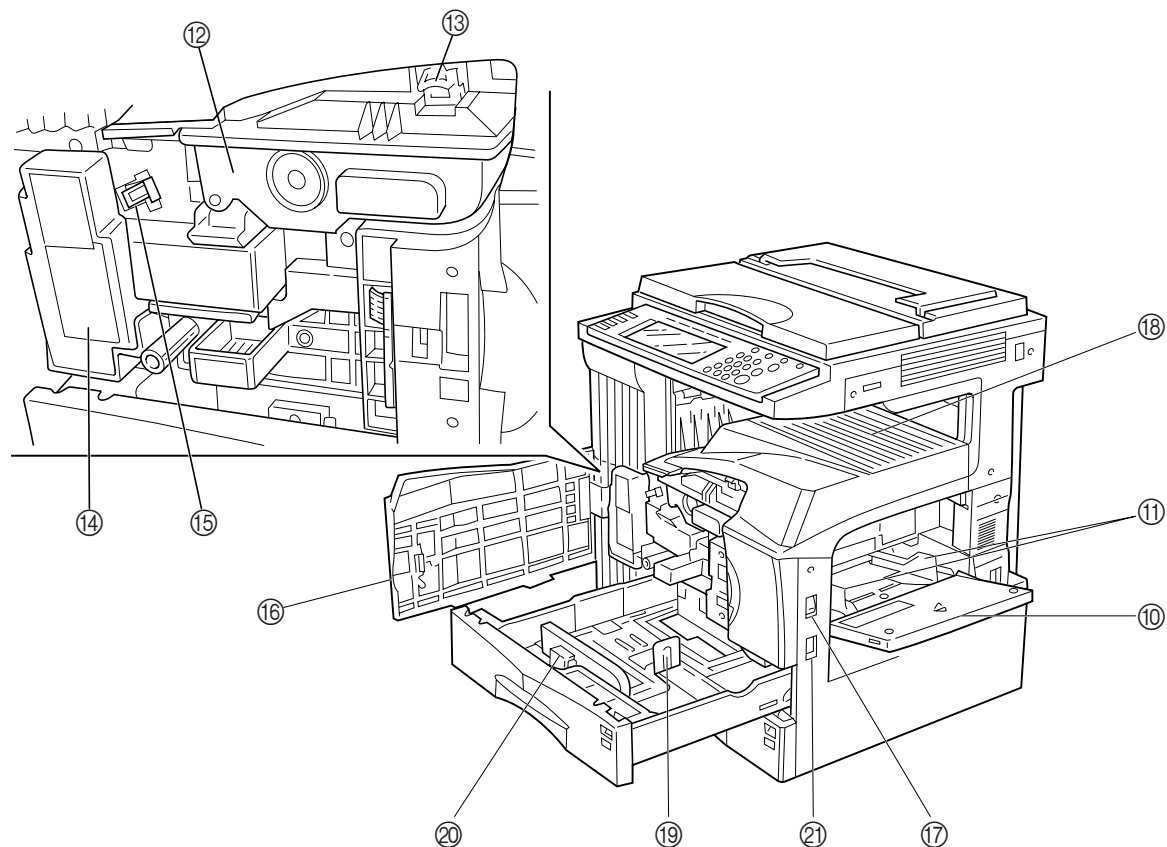

⑩ Multi-bypass tray

(Load paper here when copying onto small-size or special paper.)

⑪ Insert guides

(Be sure to set the paper width when loading paper on the multi-bypass tray.)

⑫ Toner container

⑬ Toner container release lever

(Operate to replace the toner container.)

⑭ Waste toner box

⑮ Cleaning shaft

(Pull and push back in after toner container replacement or when copy images become soiled with toner.)

⑯ Front cover

(Open to replace the toner container or waste toner box.)

⑰ Power switch

(Turn ON (I) before starting to make copies.)

⑱ Copy store section

(Copied paper is stored here.)

⑲ Length adjustment plate

(Adjust to the length of the paper to be set in the drawer[cassette].)

⑳ Width adjustment lever

(Hold the lever and adjust the width guide to the width of the paper to be set in the drawer[cassette].)

㉑ Handles for transport

(Become handles when pulled out.)

2. Operation panel

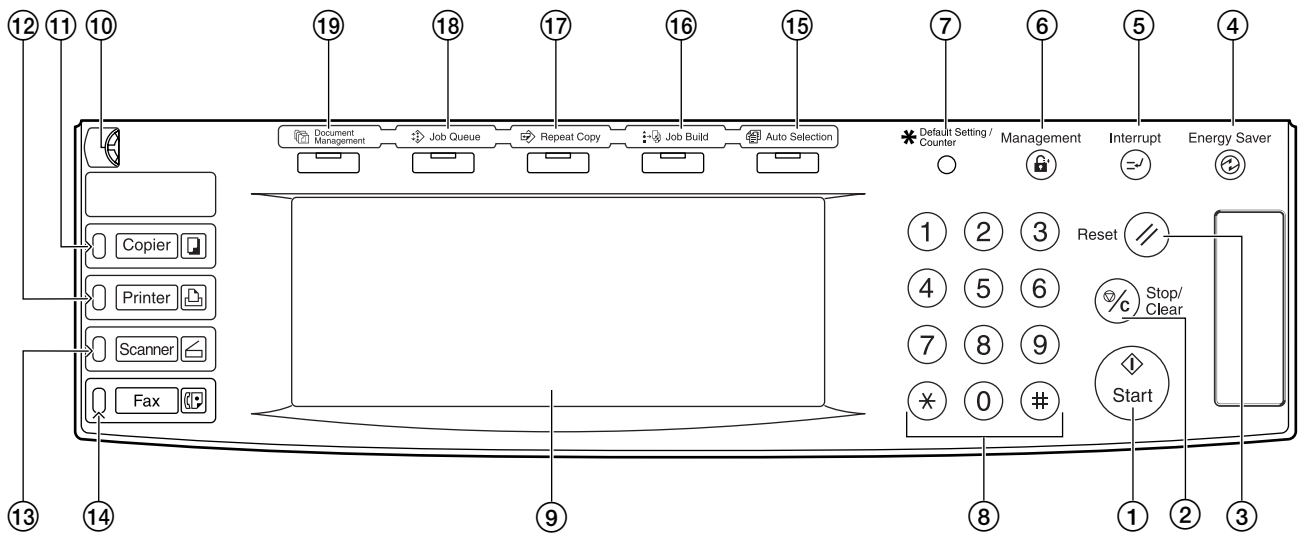

- ① **[Start] key & indicator lamp**
(Press this key when the lamp in that key is lit green and you want to start copying.)
- ② **[Stop/Clear] key**
(Press this key when you want to stop copying or change the number of copies to be made.)
- ③ **[Reset] key**
(Press this key to reset all functions to their initial mode settings. See "Initial mode" on page 2-4.)
- ④ **[Energy Saver] key & indicator lamp**
(Press this key when you want to turn the energy-saving mode ON. Press the same key again to turn the energy-saving mode OFF. See page 4-11.)
- ⑤ **[Interrupt] key & indicator lamp**
(Press this key to light the lamp in that key when you want to perform interrupt copying. See page 4-9.)
- ⑥ **[Management] key**
(When copy management is turned ON, press this key after copying in order to return to the department ID-code entry display. See page 7-1.)
- ⑦ **[Default Setting/Counter] key**
(Press this key when you want to perform default settings as well as those related to copy management, etc.)
- ⑧ **Keypad**
(Use these keys when you want to set the number of copies to be made or enter other values.)
- ⑨ **Touch panel**
(This panel displays such information as operation procedures, machine status, and the various function keys.)
- ⑩ **Brightness adjustment control dial**
(Turn this dial when you want to adjust the brightness of the touch panel.)
- ⑪ **[Copier] key, lamp & indicator**
(Press this key to light the indicator to the right of the key when you want to use the copier functions of this machine.)
- ⑫ **[Printer] key, lamp & indicator**
(Press this key when you want to use the optional printer functions of this machine. The indicator to the right of the key will light when the machine is in the printer operation mode. The lamp to the left of the key will either light green or orange, or will flash one of those colors, depending upon the status of the machine. See page 9-3.)
- ⑬ **[Scanner] key, lamp & indicator**
(Press this key when you want to use the optional scanner functions of this machine. The indicator to the right of the key will light when the machine is in the scanner operation mode. The lamp to the left of the key will either light green or orange, or will flash one of those colors, depending upon the status of the machine. See page 9-3.)
- ⑭ **[Fax] key, lamp & indicator**
(Press this key when you want to use the optional fax functions of this machine. The indicator to the right of the key will light when the machine is in the fax operation mode. The lamp to the left of the key will either light or flash green, depending upon the status of the machine.)
- ⑮ **[Auto Selection] key & indicator lamp**
(Press this key to light the lamp in that key when you want to use the auto selection mode. The optional Document Processor must be installed in your copier in order to use this mode. See page 8-3.)
- ⑯ **[Job Build] key & indicator lamp**
(Press this key to light the lamp in that key when you want to use the job build mode. See page 5-57.)
- ⑰ **[Repeat Copy] key & indicator lamp**
(Press this key to light the lamp in that key when you want to use the repeat copy mode. The optional Hard Disk must be installed on this copier in order to use this mode. See page 5-42.)
- ⑱ **[Job Queue] key & indicator lamp**
(Press this key to light the lamp in that key when you want to use the output management functions of the copier. See page 6-20.)
- ⑲ **[Document Management] key & indicator lamp**
(Press this key to light the lamp in that key when you want to use the document management functions of the copier. The optional Hard Disk must be installed on this copier in order to use this function. See page 6-1.)

Section 2 NAMES OF PARTS

● Initial mode (at the end of warm-up or when the [Reset] key is pressed)

In the default settings prepared at the factory, paper of the same size as the original is selected automatically and the copy magnification ratio is set to "100%" [1:1] (under the auto paper selection mode), the number of copies to be made is set to "1" and the image quality is set to the text+photo mode.

NOTES

- The default settings for the initial mode can be changed using the corresponding "copy default settings" procedure.
 - It is possible for you to change the default setting for the copy exposure in the initial mode from the "manual exposure mode" to the "auto exposure mode". (See "Exposure mode" on page 7-63.)
-

● Auto clear function

Once a designated amount of time has passed after copying stops (between 10 and 270 seconds), the auto clear function will automatically engage and the copier will return to the same settings as those after warm up (initial mode settings). (However, the copy exposure mode and the image quality mode will not change.) Copies can continually be made using the same settings (copy mode, number of copies and exposure mode) if the next batch of copying is started before the auto clear function engages.

● Automatic drawer[cassette] switching function

If two drawers[cassettes] contain the same size of paper and the paper in one drawer[cassette] runs out during copying, the automatic drawer[cassette] switching function will switch to paper feed from the other drawer[cassette] that still contains paper.

NOTES

- The automatic drawer[cassette] switching function can be turned OFF. (See "Auto drawer[cassette] switching ON/OFF" on page 7-42.)
 - Paper must be loaded in the same orientation in both drawers[cassettes].
 - Only drawers[cassettes] that are loaded with the same type of paper can be used with the automatic drawer[cassette] switching function.
-

3. Touch panel

Inch specifications

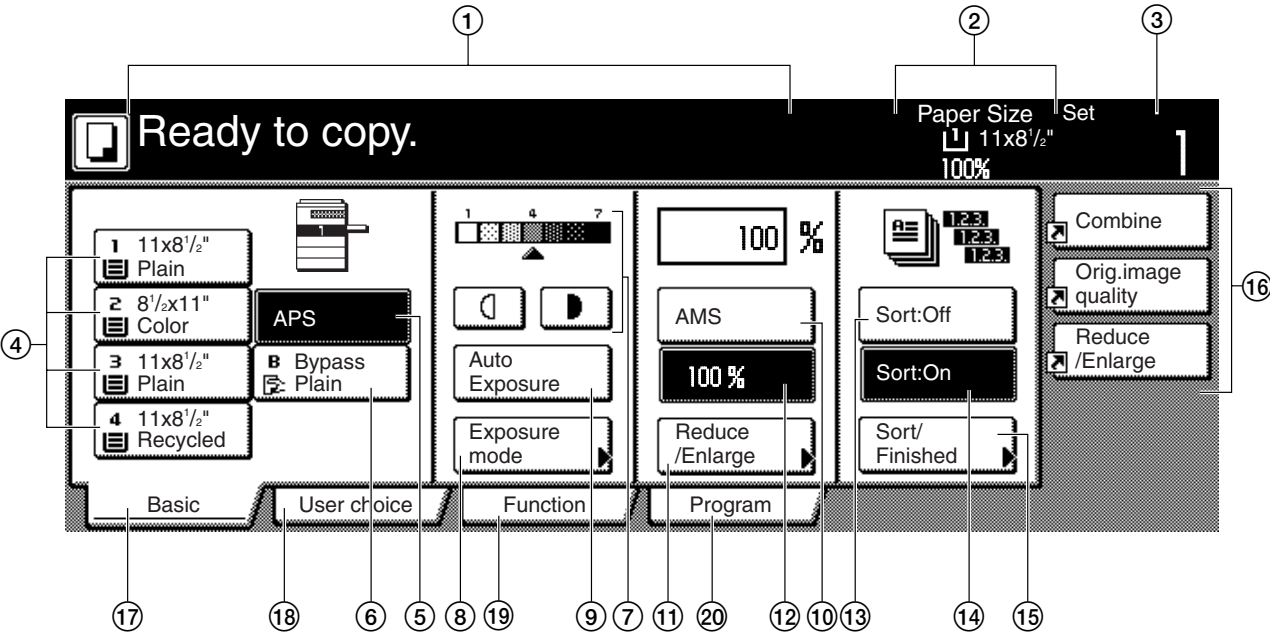

Metric specifications

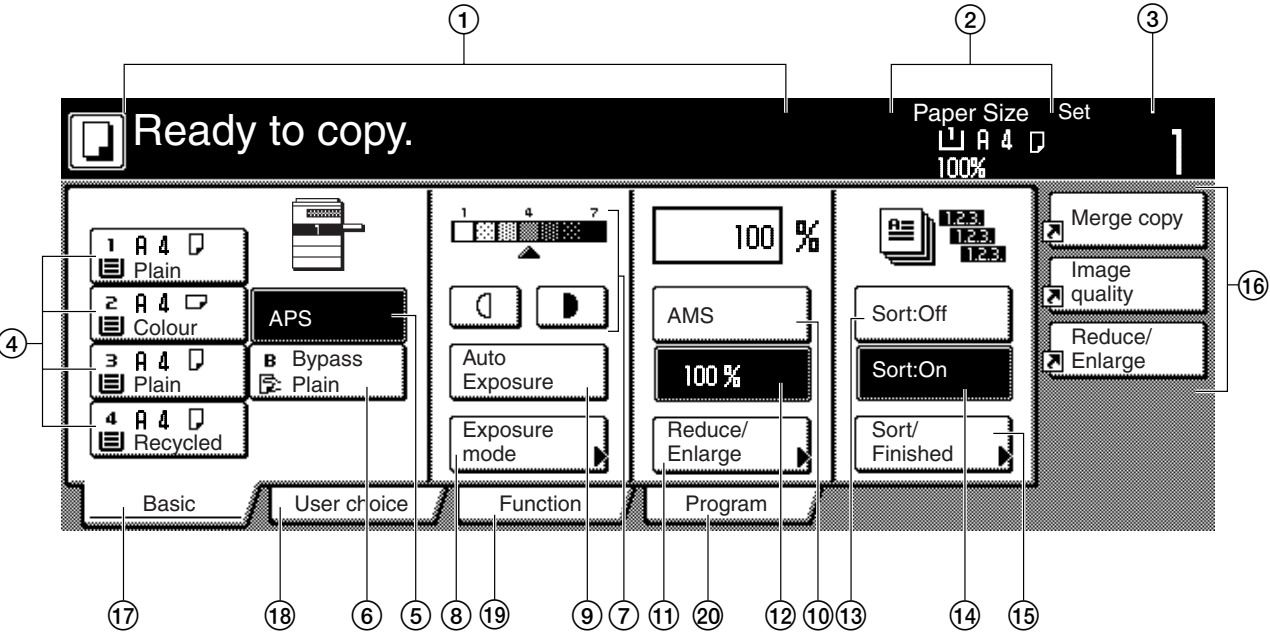

Section 2 NAMES OF PARTS

- ① This area displays messages on the machine's status and on operational procedures.
- ② This area displays information on the size of paper in the drawer[cassette] and the current copy magnification ratio.
- ③ This area displays the current number of copies to be made.
- ④ **Paper size keys (Remaining paper volume icons)**
(Touch these keys when you want to change the currently selected drawer[cassette] in order to change the size of paper that will be used. The drawer[cassette] that holds the currently selected paper size and type of paper will be highlighted. Drawer[Cassette] No.3 and drawer[cassette] No.4 will be displayed when the optional Paper Feeder is installed on your copier.)
- ⑤ **"APS" key**
(Touch this key until it is highlighted when you want to have the paper size selected automatically. See page 4-2.)
- ⑥ **"Bypass" key**
(Touch this key when you want to copy onto paper that is set on the multi-bypass tray. The type of paper registered for use on the multi-bypass tray will be indicated in the key.)
- ⑦ **Copy exposure adjustment keys / Copy exposure scale**
(Touch the appropriate key when you want to manually adjust the copy exposure. The copy exposure scale will indicate the currently selected setting. See page 4-2.)
- ⑧ **"Exposure mode" key**
(Touch this key when you want to access the "Exposure Mode" screen.)
- ⑨ **"Auto Exposure" key**
(Touch this key until it is highlighted when you want to select the auto exposure mode. In the auto exposure mode, the contrast of the original will be detected and the most suitable exposure level selected automatically. See page 4-2.)
- ⑩ **"AMS" key**
(Touch this key until it is highlighted when you want to have the copy magnification ratio selected automatically. See page 4-5.)
- ⑪ **"Reduce/Enlarge" key**
(Touch this key when you want to manually change the copy magnification ratio. See page 4-6.)
- ⑫ **"100%" (same size) key**
(Touch this key when you want to copy the original image at its actual size "100%".)
- ⑬ **"Sort:OFF" key**
(Touch this key when you want to make copies without sorting them.)
- ⑭ **"Sort:ON" key**
(Touch this key when you want to make copies in the sort mode.)
- ⑮ **"Sort/Finish" key**
(Touch this key when you want to access the "Sort/Finish" screen. See page 5-29.)
- ⑯ **Registration keys**
(Touch the appropriate key when you want to access the corresponding function or mode. Any function or mode in the "Function" tab can be registered to be displayed as one of the registration key. See page 5-53.)
- ⑰ **"Basic" tab**
(Touch this tab when you want to return the display to the contents of the "Basic" tab.)

⑱ "User choice" tab

(Touch this tab when you want to display the contents of the "User choice" tab.)

Inch specifications

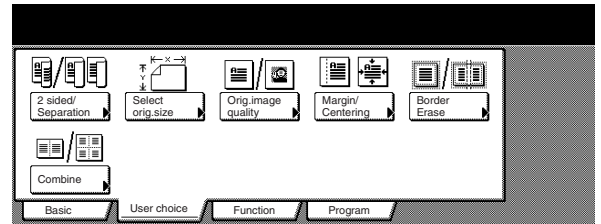

Metric specifications

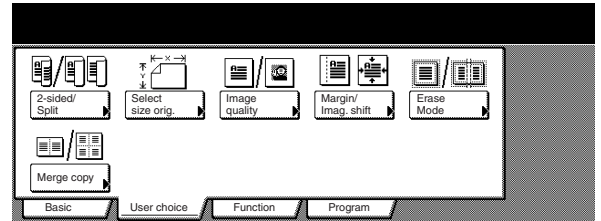

⑲ "Function" tab

(Touch this tab when you want to display the contents of the "Function" tab.)

Inch specifications

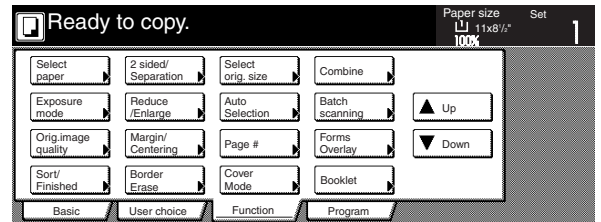

Metric specifications

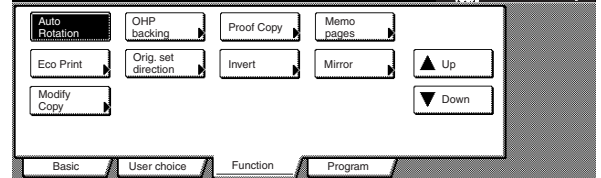

Metric specifications

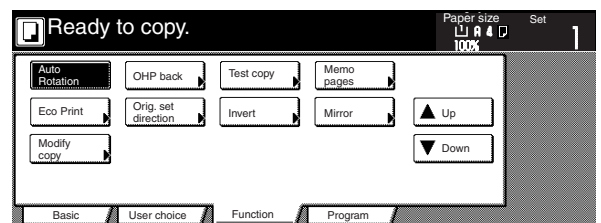
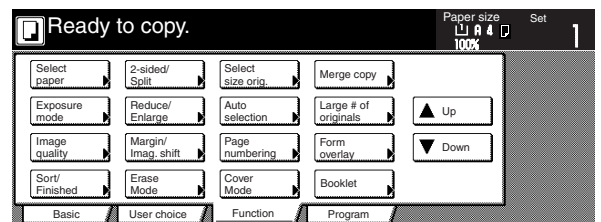

20 "Program" tab

(Touch this tab when you want to register the currently selected settings as a program, or to delete a previously registered program. See page 5-50.)

NOTE

If you press any key that has an arrow (▶) in its bottom right corner, the corresponding setting screen will be displayed.

Inch specifications

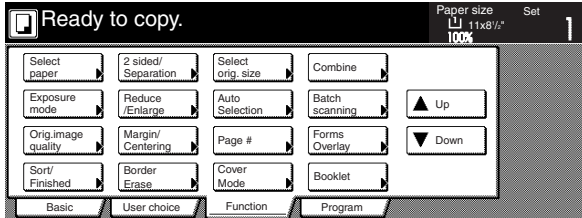

Metric specifications

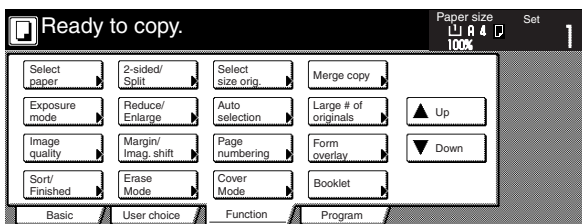

"Register" key

(Touch this key when you want to register the currently selected function or mode under a registration key. See page 5-53.)

"Back" key

(Touch this key when you want to return the settings for the currently selected mode back to their previous values.)

"Close" key

(Touch this key when you want to return to the previous screen.)

Inch specifications

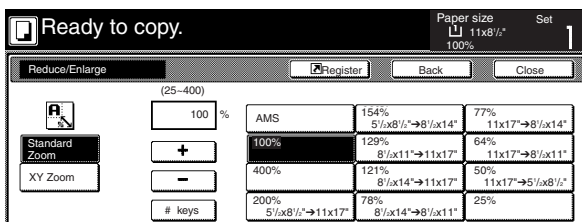

Metric specifications

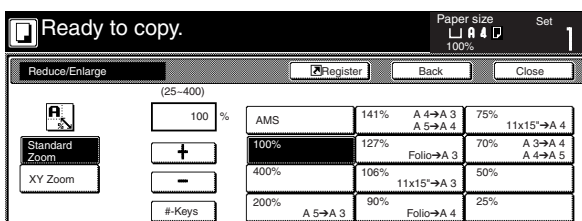

Metric specifications (Asia Pacific)

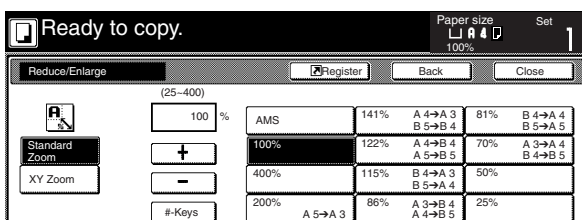

Section 3 PREPARATIONS

1. Loading paper

Paper can be loaded into the two drawers[cassettes] and the multi-bypass tray.

(1) Note when adding paper

After taking new paper out of its packaging, be sure to fan through them a few times to separate the sheets and use a flat surface to align the leading edges of the paper before loading that paper into a drawer[cassette] or setting it on the multi-bypass tray.

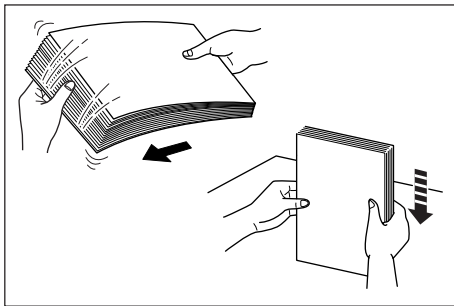

Set the paper in the drawer[cassette] with the side that was facing upward when you opened the package facing upward.

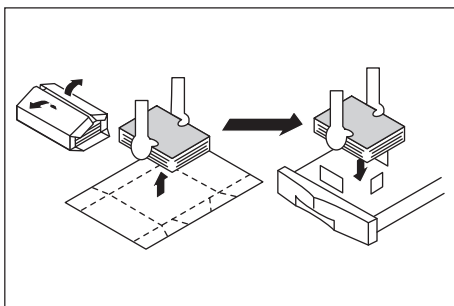

IMPORTANT!

- When copying onto used paper (paper which has already been copied onto at least one side), DO NOT use paper that is stapled or clipped together as this can be the cause of damage to the copier and/or create problems in the copy image.
- If you use paper that is curled at all, straighten the paper out before loading it into a drawer[cassette] or setting it on the multi-bypass tray, or it can cause a paper jam.

IMPORTANT!

Using special paper

In this copier, the type of paper loaded in each drawer[cassette] and on the multi-bypass tray can be specified under "Paper type (drawer[cassette] No.1 - No.4)" on page 7-44 and "(1) Paper size and type" on page 7-87, respectively.

Among the special paper that can be use with this copier, there is a wide range in paper quality and construction, especially in those types of paper noted below. For that reason, there is a greater possibility of problems occurring during copying with these type of paper. Whenever you do use such special paper as noted here, it is recommended that you first make a test copy and verify the results.

<Special paper for which extra caution is recommended>

- Preprinted
- Labels *1
- Prepunched
- Envelopes *2

*1 When using label sheets, be absolutely certain that there is no possibility that the backing glue will come into contact with any part of the copier, and that none of the labels will come off the sheet during copying.

If glue does happen to come into contact with the drum or rollers, or one of the labels comes off inside the copier, it can be the cause of major damage.

*2 The following types of envelopes should never be used:

- Those on which the glue is exposed.
- Those whereby glue will be exposed if the protective paper is removed. (If the paper protecting the glue comes off inside the copier it can be the cause of major damage.)
- Those of special construction.
- Those which have a round tab on the back and are closed with string.
- Those which have an open window.
- Those which have a transparent film window.

NOTE

When using prepunched, preprinted or letterhead paper, refer to "Special paper action setting" on page 7-46-1.

Section 3 PREPARATIONS

(2) Loading paper into the drawer[cassette]

Up to 500 sheets of standard paper (75 or 80 g/m²/standard paper as specified by our company) or colored paper can be loaded into the each drawer[cassette].

The each drawer[cassette] can be set to hold paper of any desired size from 5 1/2" x 8 1/2", 8 1/2" x 11", 11" x 8 1/2", 8 1/2" x 13", 8 1/2" x 14", 11" x 17", A5R, B5R, B5, A4R, A4, B4, A3, Folio, 8K and 16K.

IMPORTANT!

Set the type of paper (standard paper, recycled paper, etc.) to be loaded in the drawer[cassette] in "Paper type (drawer[cassette] No.1 - No. 4)" on page 7-44.

- 1 Pull the drawer[cassette] out toward you as far as it will go.
* Do not pull more than one drawer[cassette] out at a time.

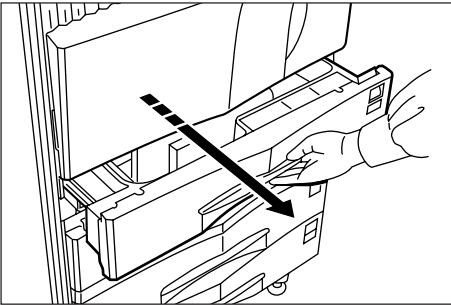

- 2 Hold the width adjustment lever and move it to align the width guide with the required paper width. Paper sizes are marked inside the drawer[cassette].

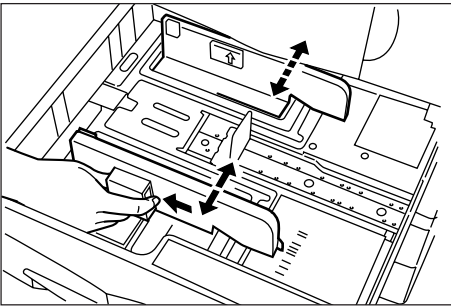

- 3 Hold the length adjustment plate and move it to align with the required paper length.

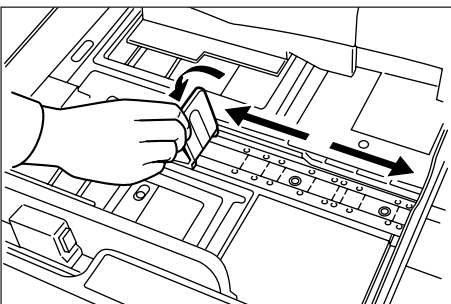

- 4 Set the paper flush against the left-hand wall of the drawer[cassette].

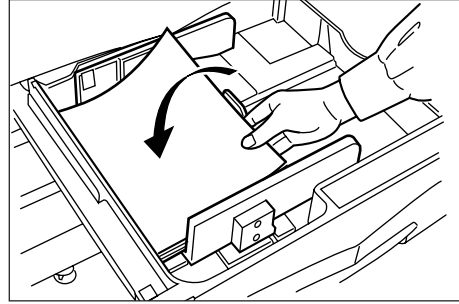

IMPORTANT!

- Make sure that there are no folds, etc., in the paper when it is set in a drawer[cassette]. Such paper may be the cause of paper jams.
- There is a sticker (① in the illustration) indicating paper capacity attached to the inside of the drawer[cassette]. Do not load paper above this limit.
- When you are loading paper into a drawer[cassette], make sure that the side facing upward when the package is opened is the side that is facing upward in the drawer[cassette].
- Adjust the length adjustment plate and the width guide BEFORE loading paper into a drawer[cassette]. Failure to do so may result in skewed paper feed or a paper jam.
- Make sure that the paper is set securely against the length adjustment plate and the width guide. If there is a gap between the paper and the adjustment plate or the width guide, readjust the plate and the guide to fit the paper snugly.

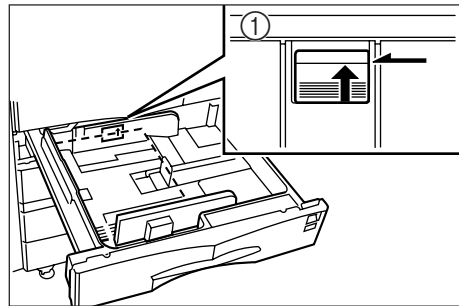

- 5** Set the supplied paper size sheet so that the size of the paper loaded can be checked by looking at the front of the drawer[cassette].

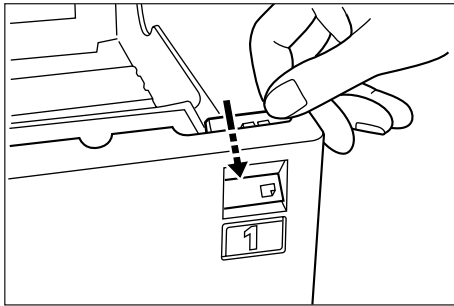

- 6** Gently push the drawer[cassette] back in.

NOTE

Before leaving the copier in disuse for a prolonged period of time, remove the paper from the drawer(s)[cassette(s)] and seal it in its original packaging to protect from moisture. Also, when storing paper in a high temperature and high humidity environment, seal it in a moisture-proof bag.

(3) Loading paper into the multi-bypass tray

Up to 200 sheets of standard copy paper (75 g/m² – 80 g/m²), of a size between 11" x 17" [A3] and 5 1/2" x 8 1/2" [A6R] can be set on the multi-bypass tray at one time. When copying onto special paper, be sure to use the multi-bypass tray.

NOTE

The types of special paper and the number of sheets that can be loaded in the multi-bypass tray are:

- Transparencies: 25 sheets
- Standard paper (120 g/m²): 130 sheets
- Standard paper (160 g/m²): 100 sheets

IMPORTANT!

- When copying onto OHP transparencies, be sure to fan through them a few times to separate the sheets before setting them on the multi-bypass tray.
- When copying onto non-standard size paper, perform the procedure in "(1) Paper size and type" on page 7-87 and select the paper size.
- When setting special paper such as OHP transparencies and thick paper on the multi-bypass tray, the type of paper must be specified under "(1) Paper size and type" on page 7-87.
- You can select to have the "Bypass setting" screen (see page 7-86) displayed whenever the "Bypass" key is touched. (See "Multi-bypass tray setting display ON/OFF" on page 7-45.)

- 1** Open the multi-bypass tray.

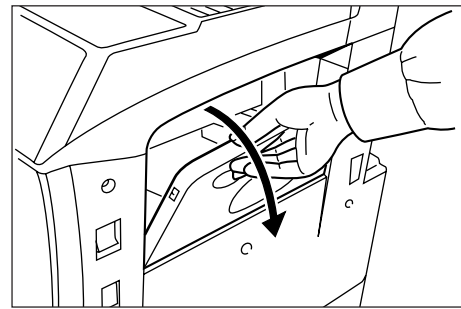

- 2** Adjust the insert guides to the size of the paper to be loaded.

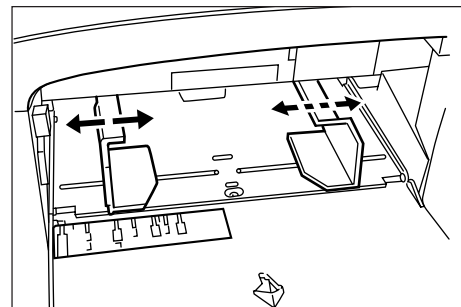

- 3** Insert the paper along the guides as far as it will go.

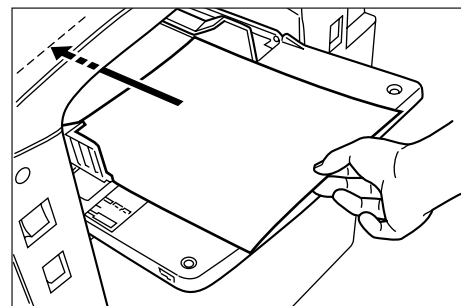

IMPORTANT!

- When you are setting paper onto the multi-bypass tray, make sure that the side facing upward when the package is opened is the side that is facing upward on the multi-bypass tray as well. In addition, if the leading edge of the paper is curled at all, straighten it out before setting it on the multi-bypass tray.
- ALWAYS straighten out curled paper before setting it on the multi-bypass tray.

Section 3 PREPARATIONS

● Setting envelopes

Up to 20 envelopes can be set on the multi-bypass tray at a time. Refer to the following table for the types and sizes of envelopes that can be used in this machine.

| Acceptable envelope types | Size |
|---------------------------|------------------|
| Monarch | 3 1/8" x 7 1/2" |
| Comm. #10 | 3 3/8" x 9 1/2" |
| Envelope DL | 110 x 220 (mm) |
| Envelope C5 | 162 x 229 (mm) |
| Executive | 7 1/4" x 10 1/2" |
| Comm. #9 | 3 7/8" x 8 7/8" |
| Comm. #6-3/4 | 3 5/8" x 6 1/2" |
| ISO B5 | 176 x 250 (mm) |
| Envelope C4 | 229 x 324 (mm) |
| Oufuku Hagaki | 200 x 148 (mm) |
| YOUKEI 2 | 162 x 114 (mm) |
| YOUKEI 4 | 234 x 105 (mm) |

1 Open the multi-bypass tray.

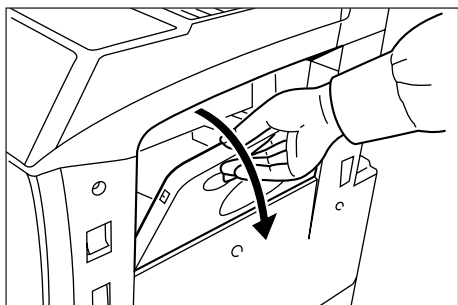

2 Align the insert guides with the envelope size.

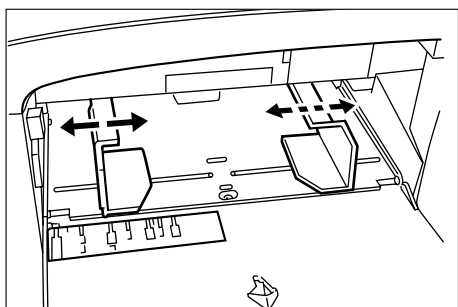

3 When using envelopes that are wider than they are tall, leave the flap closed and set the envelopes with the copy side facing upward and the flap facing towards the rear of the copier. Then slide the envelopes into the slot along the insert guides as far as they will go.

When using envelopes that are taller than they are wide, open the flap and set the envelopes with the copy side facing upward and the flap facing away from the direction of insertion. Then slide the envelopes into the slot along the insert guides as far as they will go.

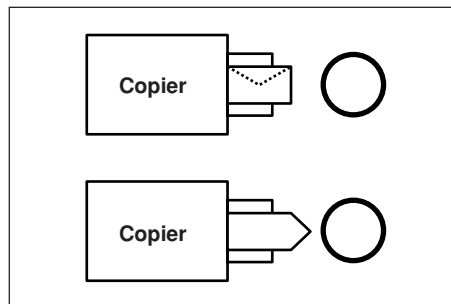

NOTES

- If the optional Printer Kit or Printer/scanner Kit is installed on your copier and you attempt to print from a computer onto envelopes that are wider than they are tall, be sure to leave the flap closed and set the envelopes with the side to be printed onto facing upward. Orient the edge with the flap towards the front of the copier and then slide the envelopes into the slot along the insert guides as far as they will go.

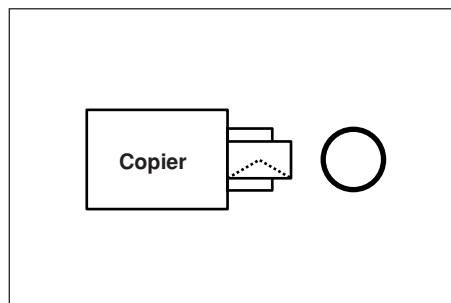

- The proper orientation will actually depend upon the type of envelope being used.
- Incorrectly loading envelopes can result in printing in the wrong orientation or on the wrong side.
- When setting envelopes on the multi-bypass tray, BE SURE to specify the type of envelopes that will be used under "3. Multi-bypass tray paper settings" on page 7-87.

Section 4 BASIC OPERATION

1. Basic copying procedure

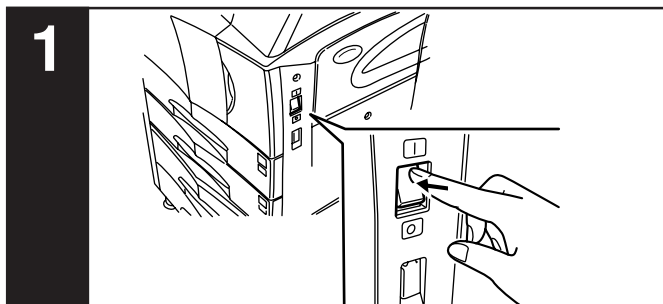

1. Warm-up

Turn the power switch ON (|). At the end of warm-up, "Ready to copy." will be displayed.

NOTE

If you set the originals that you want to copy and press the [Start] key while the copier is still warming up, copying will begin as soon as warm-up is finished.

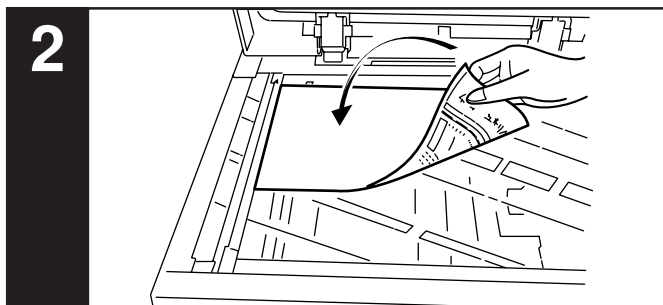

2. Setting the originals

Open the original cover and set the original that you want to copy face-down on the platen. Be sure to align originals with the upper left corner of the platen (towards the left-rear portion of the copier).

NOTE

See "④ How to set originals in the Document Processor" on page 8-2 for instructions on how to set originals in your Document Processor (option).

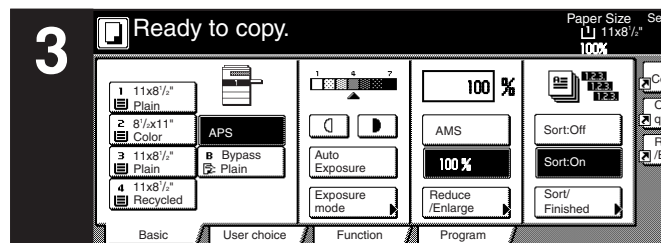

Inch specifications

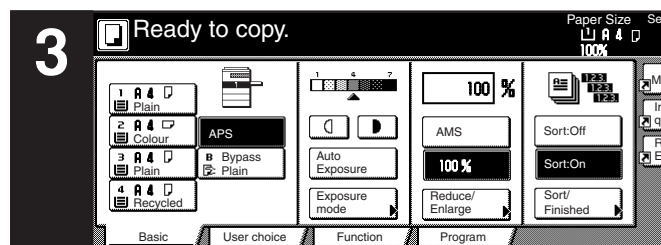

Metric specifications

3. Selecting the desired functions

Select from among the copier's various modes and functions.

- Enlarging/reducing the copy image (Page 4-5.)
- Interrupt copying (Page 4-9.)
- Making 2-sided copies from various types of originals (Page 5-1.)
- Copying each image of open-faced (books, magazines, etc.) or 2-sided originals onto separate sheets (Page 5-4.)
- Creating a margin on the copies (Page 5-6.)
- Centering the copy image (Page 5-8.)
- Adding a space next to the copy images for making notes (Page 5-9.)
- Making copies with clean edges (Page 5-11.)
- Fitting the image of either two or four originals onto a single copy page (Page 5-13.)
- Printing page numbers on the copies (Page 5-16.)
- Overlaying one image over another (Page 5-20.)
- Making booklets from sheet originals (Page 5-22.)
- Making booklets from book originals (Page 5-26.)
- Automatic sorting of copy sets without the Document Finisher (Page 5-29.)
- Automatic rotation of the copy image (Page 5-30.)
- Adding a front and/or back cover to your copy sets (Page 5-31.)
- Feeding paper as a backing sheet for OHP transparencies (Page 5-36.)
- Inverting black and white (Page 5-38.)
- Making mirror image copies (Page 5-39.)
- Making a test copy prior to large volume copying (Page 5-40.)
- Making more of the same copies after a copy job is finished (Page 5-42.)
- Copying a large volume of originals in one operation (Page 5-47.)
- Easily add covers and insert sheets between various sets of originals in one operation (Page 5-57.)

Section 4 BASIC OPERATION

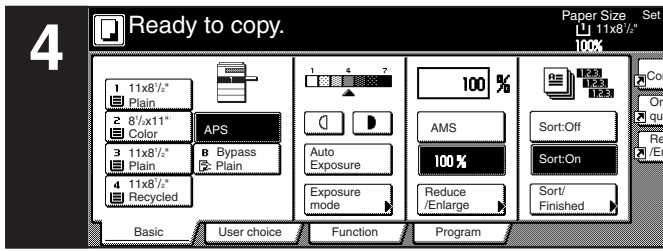

Inch specifications

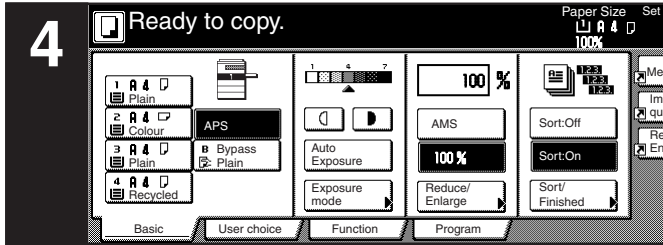

Metric specifications

4. Selecting the paper size

When the “APS” key is highlighted on the touch panel, copy paper of the same size as the original will be automatically selected. In order to copy the original onto a different size of paper without changing the size of the image, touch the paper size key that corresponds to the paper size that you want to use.

NOTES

- You can stop the copier from automatically selecting the paper size. (See “Paper selection” on page 7-68.)
- It is also possible for you to specify one drawer[cassette] that will be selected automatically regardless of the size of paper loaded in that drawer[cassette]. (See “Default drawer[cassette]” on page 7-70.)

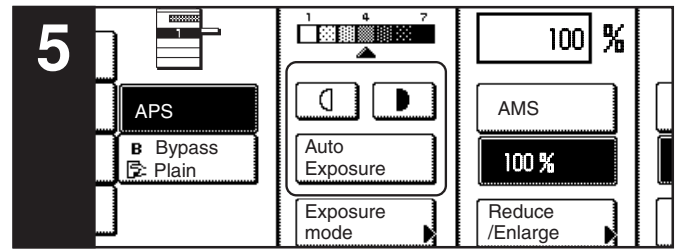

Inch specifications

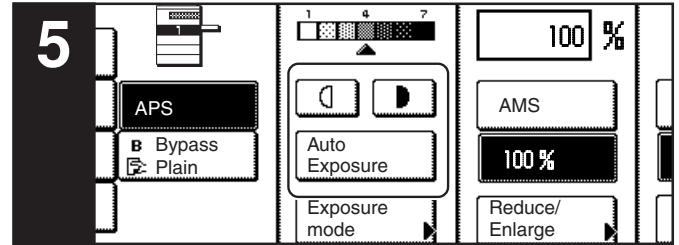

Metric specifications

5. Adjusting the copy exposure

Adjustment of the copy exposure is generally accomplished manually. If you want to make the exposure darker, touch the right exposure adjustment key to move the arrow under the exposure scale to the right; if you want to make the exposure lighter, touch the left exposure adjustment key to move the arrow under the exposure scale to the left.

If you want the copy exposure to be adjusted automatically, touch the “Auto Exposure” key until it is highlighted. The contrast of the original will be detected and the most suitable exposure level selected automatically.

- * It is also possible for you to adjust the copy exposure by touching the “Exposure Mode” key to access the “Exposure Mode” screen. Copy exposure adjustment can then be performed in this screen using the same methods as above.

Inch specifications

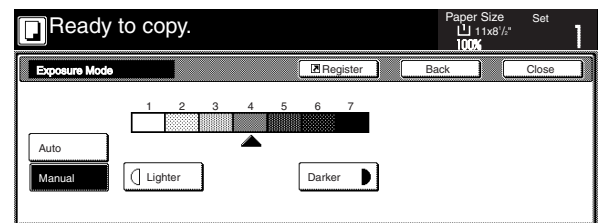

Metric specifications

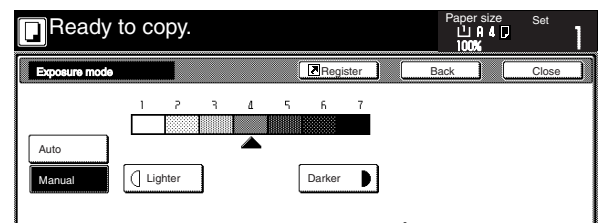

NOTES

- It is possible for you to make adjustments to the auto exposure mode if the overall copies come out too dark or too light. (See “Auto exposure adjustment” on page 7-73.)
- It is also possible for you to change the default setting for the copy exposure to the auto exposure mode. (See “Exposure mode” on page 7-63.)

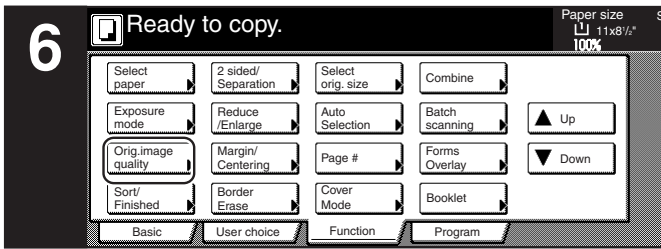

Inch specifications

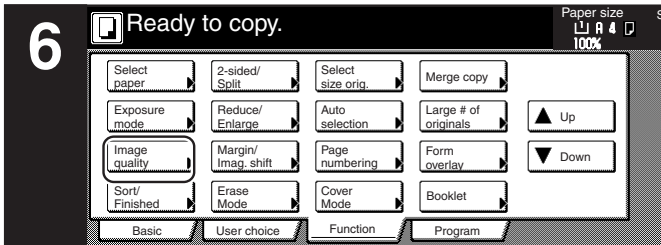

Metric specifications

6. Selecting the image quality

The image quality is selected according to the type of original. Touch the “Function” tab and then the resulting “Orig. image quality” [“Image quality”] key that is displayed within that tab in order to access the “Orig. image quality” [“Image quality orig.”] screen.

Inch specifications

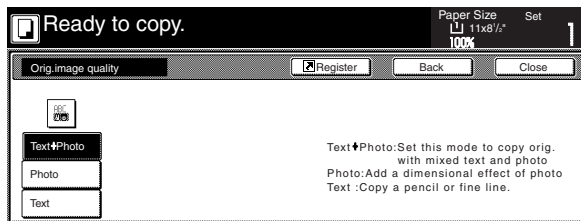

Metric specifications

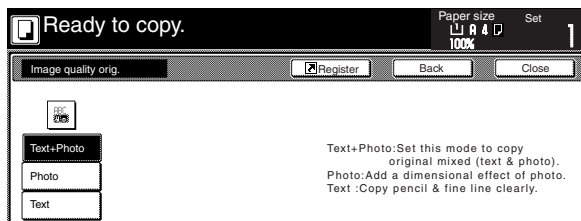

- Text+photo mode:** Touch the “Text+Photo” key until it is highlighted. Select this mode when the original contains a mixture of both text and photographs.
- Photo mode:** Touch the “Photo” key until it is highlighted. Select this mode to bring out the depth in photographs.
- Text mode:** Touch the “Text” key until it is highlighted. Select this mode especially to reproduce originals written in pencil of which contain thin lines.

NOTES

- It is possible for you to change the image quality mode that will be the default setting in the initial mode. (See “Original quality” on page 7-65.)
- It is also possible for you to adjust the copy exposure in each of the image quality modes. (See “Manual exposure adjustment (text+photo mode)” on page 7-75, “Manual exposure adjustment (text mode)” on page 7-76 and “Manual exposure adjustment (photo mode)” on page 7-77.)

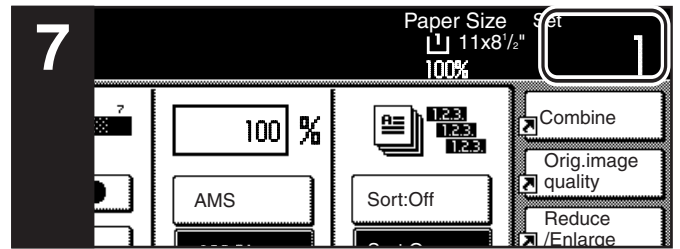

Inch specifications

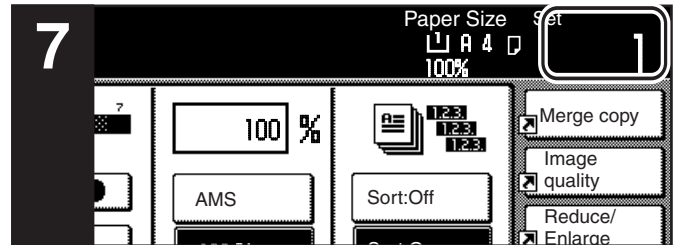

Metric specifications

7. Setting the number of copies to be made

Use the keypad to change the number of copies to be made that is displayed on the touch panel to the actual number that you want to make. Up to 999 copies can be made at one time.

NOTE

It is possible for you to limit the number of copies (or copy sets) that can be made at a time. (See “Copy limit” on page 7-82.)

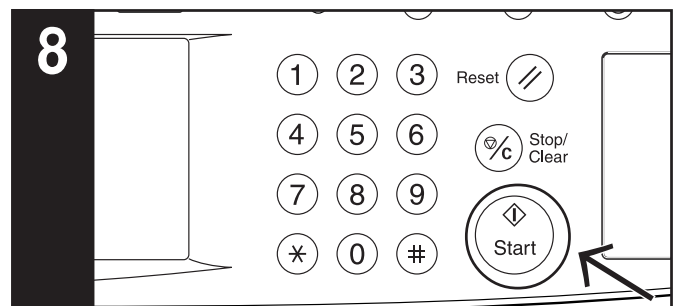

8. Start copying

Press the [Start] key. Once the lamp in the [Start] key is lit green and “Ready to copy.” is displayed, copying is possible.

Inch specifications

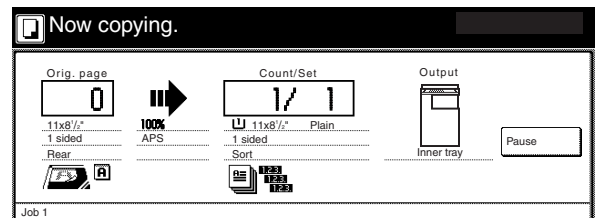

Metric specifications

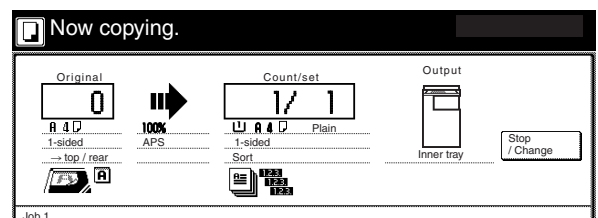

9

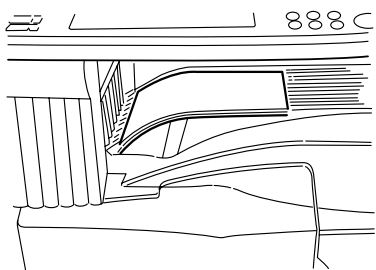

9. At the end of copying

Finished copies will be ejected onto the copy store section.

IMPORTANT!

- Up to 250 copies can be stored on the copy store section.
 - If "The output tray exceeds capacity. Remove the paper." ["Too much paper in output tray. Remove paper."] is displayed, there are too many copies on the top tray. Remove the copies from the copy store section and then press the [Start] key to resume copying.
 - If ejected copies come out curled, or are otherwise not stored cleanly, remove the paper from the drawer[cassette] or the multi-bypass tray (whichever is currently being used), turn the paper over, set it again in that location and try to copy again.
-

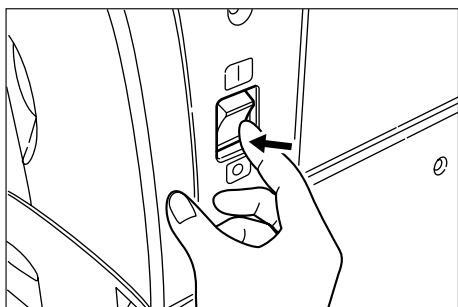

CAUTION

If the copier will not be used for a short period of time (overnight, etc.), turn the power switch OFF (O).
If it will not be used for an extended period of time (vacations, etc.), remove the power plug from the outlet for safety purposes during the time the copier is not in use.

2. Enlarging/reducing the copy image

(1) Auto magnification selection mode

With this mode, the original image is enlarged/reduced automatically according to the selected paper size.

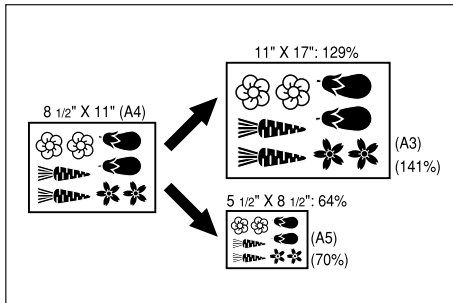

IMPORTANT!

If you use this mode most often, select "AMS" under "Default magnification ratio" on page 7-72.

- 2 Select the size of paper that you want to copy onto by touching the appropriate paper size key. Touch the "AMS" key. The corresponding magnification ratio will be displayed.

Inch specifications

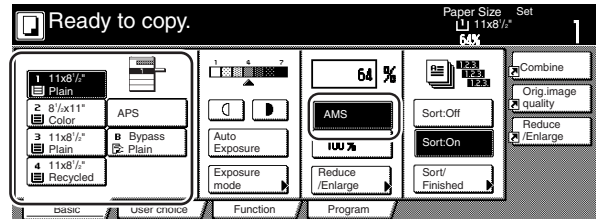

Metric specifications

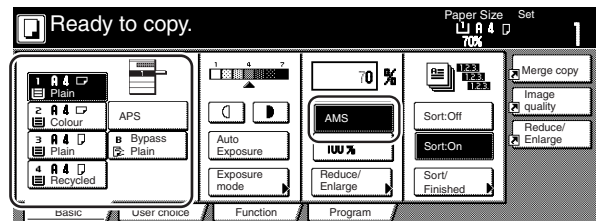

- 1 Set the original to be copied. The copier will automatically detect the size of the originals and select copy paper of that same size.

Inch specifications

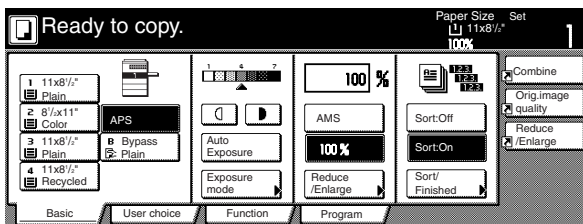

Metric specifications

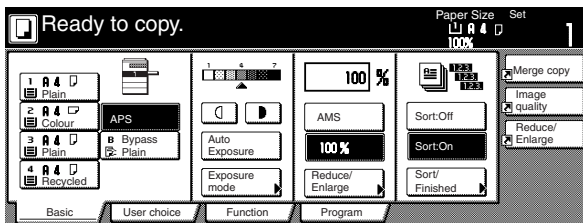

- 3 Press the [Start] key to begin the copying procedure.

Section 4 BASIC OPERATION

(2) Zoom mode

With this mode, the magnification ratio can be set to any 1% increment between 25% and 400%.

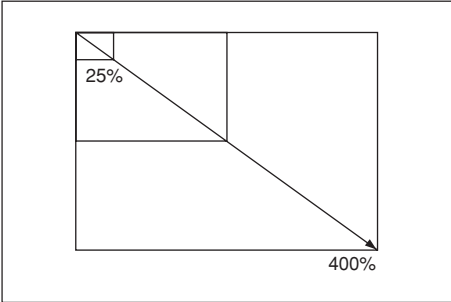

1 Set the original to be copied.

2 Touch the “Reduce/Enlarge” key. The “Reduce/Enlarge” screen will be displayed.

Inch specifications

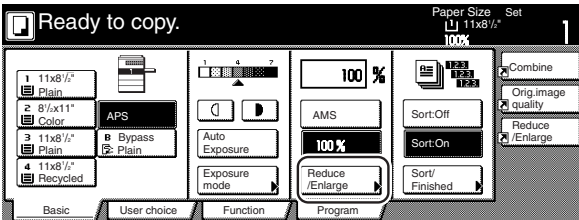

Metric specifications

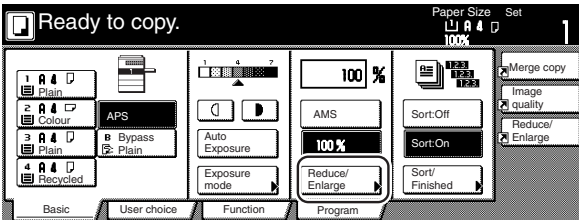

3 Touch the “+” key or the “-” key to change the displayed magnification ratio to the desired setting.

* The desired magnification ratio can also be entered directly by touching the “# keys” [“#-Keys”] key and then using the keypad.

Inch specifications

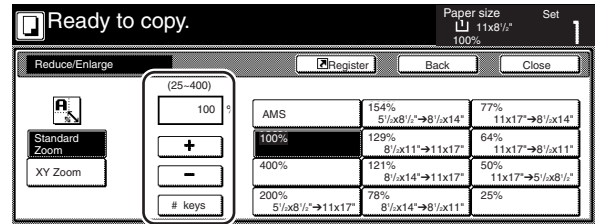

Metric specifications

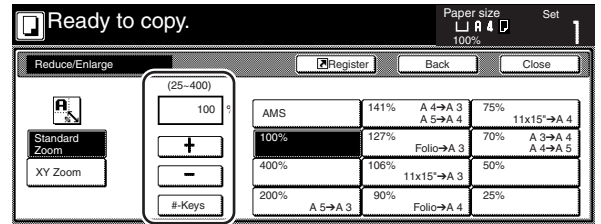

Metric specifications (Asia Pacific)

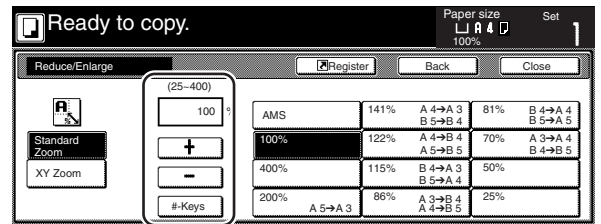

4 Press the [Start] key to begin the copying procedure.

(3) Preset zoom mode

With this mode, the magnification ratio can be set to one of the pre-set ratios:

[Available magnification ratios]

Inch specification

- Reduction 25%
50% (11" x 17" → 5 1/2" x 8 1/2")
64% (11" x 17" → 8 1/2" x 11")
77% (11" x 17" → 8 1/2" x 14")
78% (8 1/2" x 14" → 8 1/2" x 11")
- Enlargement 121% (8 1/2" x 14" → 11" x 17")
129% (8 1/2" x 11" → 11" x 17")
154% (5 1/2" x 8 1/2" → 8 1/2" x 14")
200% (5 1/2" x 8 1/2" → 11" x 17")
400%

Metric specification

- Reduction 25%
50%
70% (A3 → A4, A4 → A5)
75% (11" x 15" → A4)
90% (Folio → A4)
- Enlargement 106% (11" x 15" → A3)
127% (Folio → A3)
141% (A4 → A3, A5 → A4)
200% (A5 → A3)
400%

Metric specification (Asia Pacific)

- Reduction 25%
50%
70% (A3 → A4, B4 → B5)
81% (B4 → A4, B5 → A5)
86% (A3 → B4, A4 → B5)
- Enlargement 115% (B4 → A3, B5 → A4)
122% (A4 → B4, A5 → B5)
141% (A4 → A3, B5 → B4)
200% (A5 → A3)
400%

3 Touch the preset zoom key that corresponds to the magnification ratio that you want to use.

Inch specifications

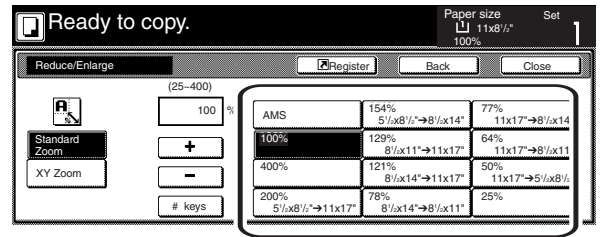

Metric specifications

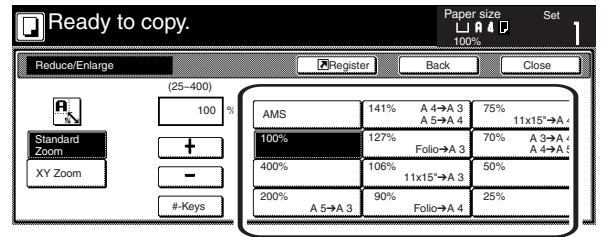

Metric specifications (Asia Pacific)

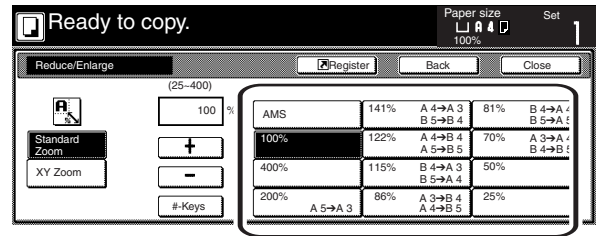

NOTE

You can also change the magnification ratio in 1% increments by touching the "+" key or the "-" key, as appropriate.

1 Set the original to be copied.

2 Touch the "Reduce/Enlarge" key. The "Reduce/Enlarge" screen will be displayed.

Inch specifications

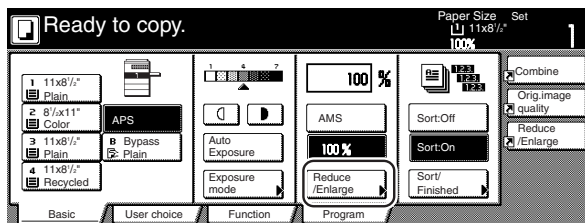

Metric specifications

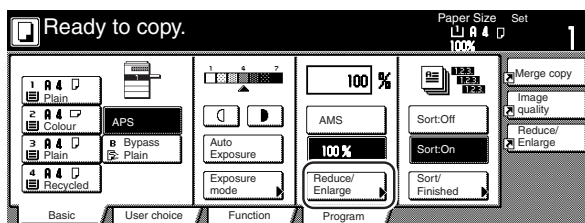

4 Press the [Start] key to begin the copying procedure.

Section 4 BASIC OPERATION

(4) XY zoom mode

With this mode, it is possible for you to select the length and width of the copy image separately. The magnification ratio can be set to any 1% increment between 25% and 400%.

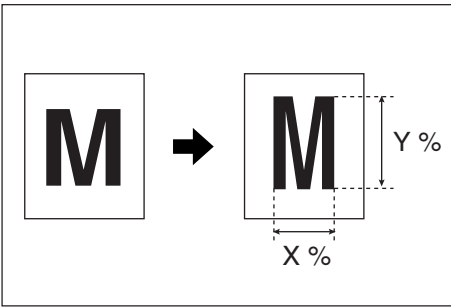

- 1 Set the originals to be copied.
- 2 Touch the "Reduce/Enlarge" key.
The "Reduce/Enlarge" screen will be displayed.

Inch specifications

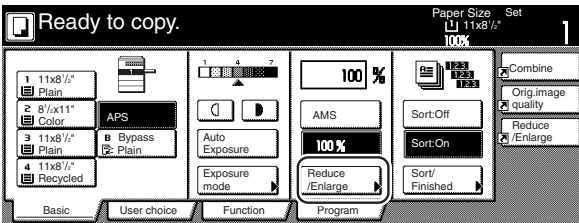

Metric specifications

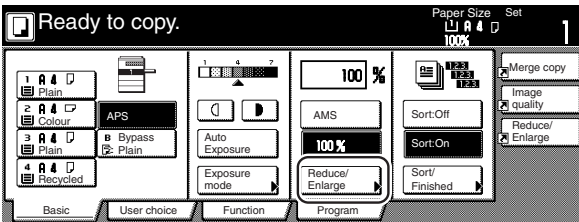

- 3 Touch the "XY Zoom" key.
The screen to select the magnification ratio will be displayed.

Inch specifications

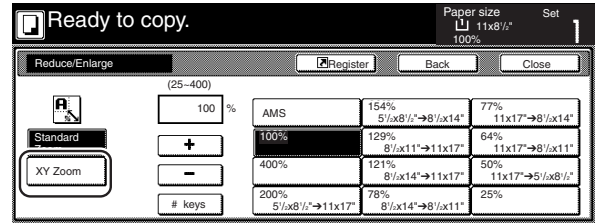

Metric specifications

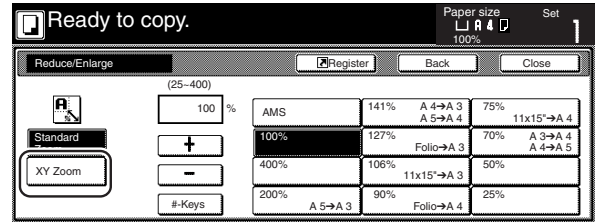

Metric specifications (Asia Pacific)

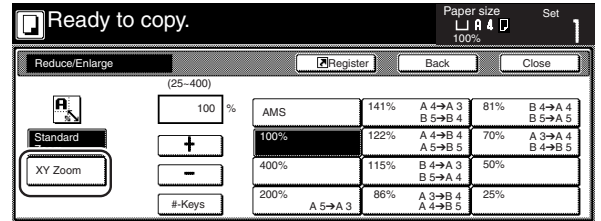

- 4 Touch the "+" key or the "-" key, as appropriate, specify the desired magnification ratio for the width and then the length of the image. It is also possible for you to enter the desired ratio directly by touching the corresponding "# keys" ["#-Keys"] key and then using the keypad.

Inch specifications

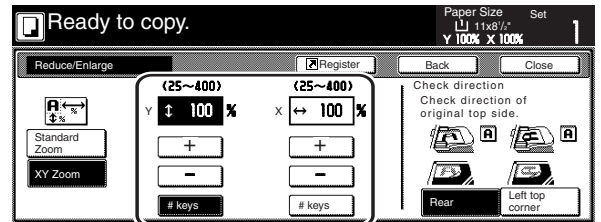

Metric specifications

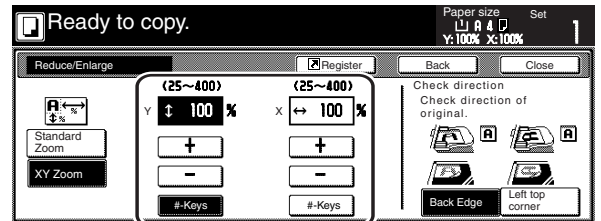

- 5 Touch the appropriate key on the right side of the touch panel to specify the direction in which the original was set.
- 6 Press the [Start] key to begin the copying procedure.

3. Interrupt copying

Interrupt copying is useful if, during one copy job, you want to copy other originals at different settings. Once the rush job is completed, the interrupted copy job can be resumed at the same settings as before.

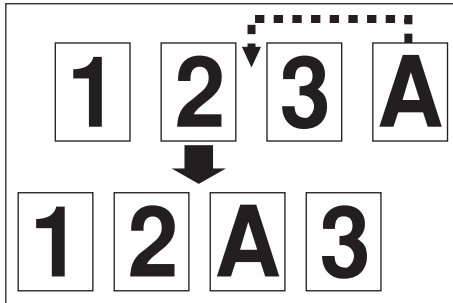

- 1 Press the [Interrupt] key to light the lamp in the [Interrupt] key. "Interrupt mode OK" will be displayed.

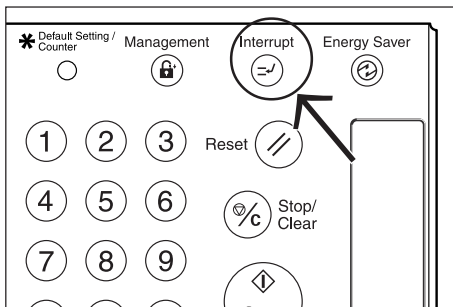

- 2 Remove the originals that were currently being copied and put them aside.

- 3 Set the new originals and perform the desired copy procedure.

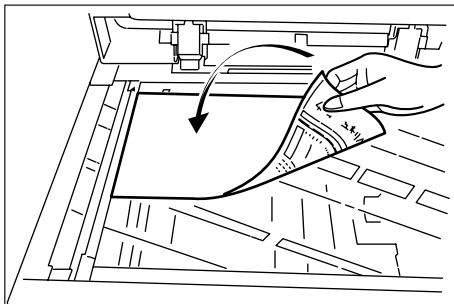

- 4 When copying is completed, press the [Interrupt] key once again. The lamp in the [Interrupt] key will go out. Replace the newly copied originals with the ones removed before. Then, press the [Start] key. The interrupted copy job will be resumed.

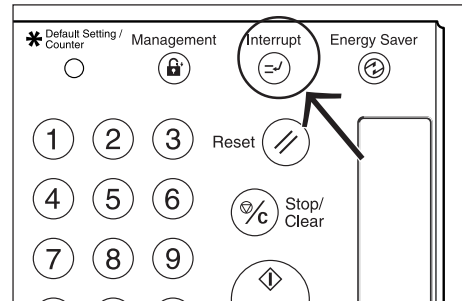

4. Job reservation

Copy jobs can be scheduled even while another copy job is in progress any time the “Reserve next copy” key is displayed.

Inch specifications

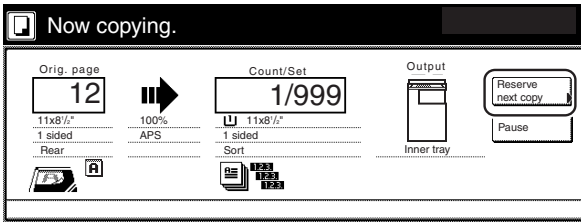

Metric specifications

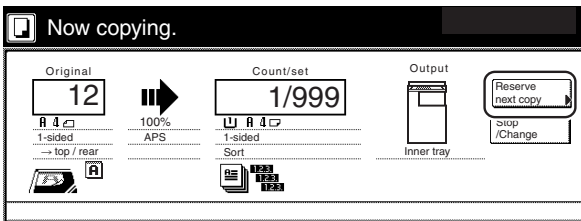

You can enter the corresponding copy settings and scan in the originals in preparation for your copy job even before the other job is completed. Once that job is finished and print out is possible, the operation for the reserved job will begin automatically.

NOTES

- The optional Hard Disk must be installed on your copier in order to use this function.
- If the optional Fax Kit, Printer Kit or Printer/Scanner Kit are installed in your copier, job reservation will be possible during print out of both received fax jobs and print jobs.

- 1 Touch the “Reserve next copy” key. The “Ready to copy. (Job reservation)” screen will be displayed.

Inch specifications

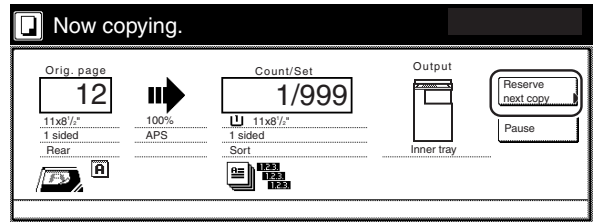

Metric specifications

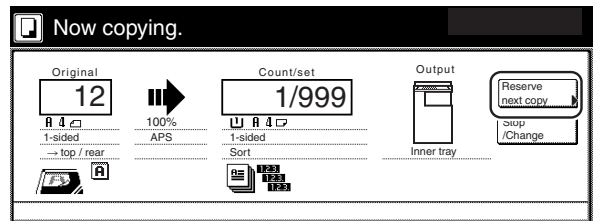

NOTE

Job reservation is not available if the “Reserve next copy” key isn't displayed.

- 2 Set the originals to be copied.
- 3 Select the settings and functions that you want to use for that copy job.

Inch specifications

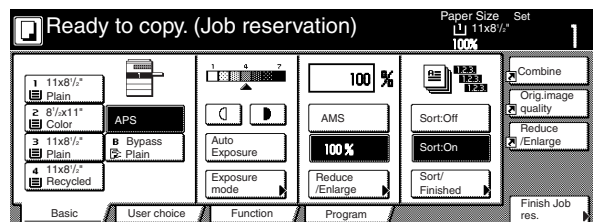

Metric specifications

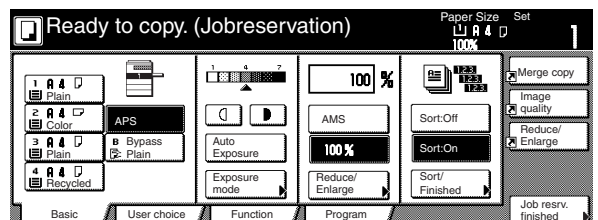

- 4 Press the [Start] key. Scanning of the originals will start. Once all of the originals have been completely scanned, the touch panel will return to the screen in step 1.

5. Energy-saving modes

If you press the [Energy Saver] key, even while the power switch is still turned ON, the copier will enter one of the following two energy-saving modes (a state of rest).

● Low power mode

The lamp in the [Energy Saver] key will be the only lit indication on the operation panel. To resume copying, press the [Energy Saver] key once again. It will take the copier less than 12 seconds to return to a copy-ready state.

● Sleep mode

Just like with the Low power mode, the lamp in the [Energy Saver] key will be the only lit indication on the operation panel, but even less power will be consumed in this mode. To resume copying, press the [Energy Saver] key once again. It will take the copier less than 25 seconds to return to a copy-ready state.

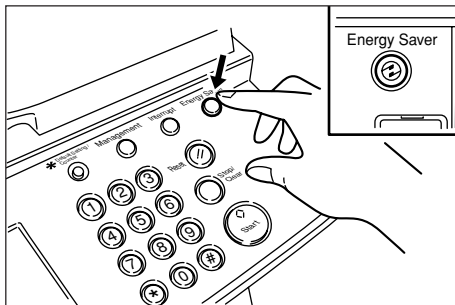

The following two functions will also automatically cause the copier to enter the corresponding energy-saving mode if no operation is performed for a designated period of time.

● Auto low power function

If no operation is performed on the copier for a designated period of time (adjustable between 1 and 240 minutes), the auto low power function will engage and cause the copier to automatically enter the Low power mode.

The factory default setting is for 15 minutes.

● Auto sleep function

If no operation is performed on the copier for a designated period of time (adjustable between 1 and 240 minutes), the auto sleep function will engage and automatically turn the power switch OFF (O). When you want to make copies again, simply turn the power switch back ON (I).

The factory default setting is for 60 minutes.

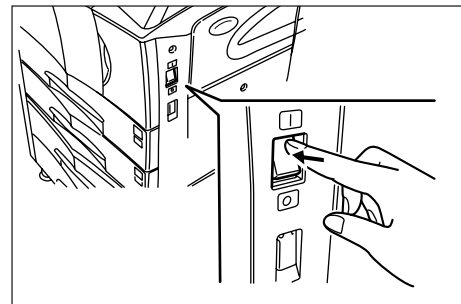

NOTES

- If the optional Printer Kit or Printer/Scanner Kit is installed in your copier, you can switch between the energy-saving modes (Low power mode and Sleep mode) that will be entered into when the [Energy Saver] key is pressed. To change the energy-saving mode, see "Changing the energy-saving mode" on page 7-58.
- If you are using a standard copier, or if the optional Fax Kit is installed in your copier, you can press the [Energy Saver] key to engage the Low power mode.
- If the optional Fax Kit, Printer Kit or Printer/Scanner Kit are installed in your copier and a received fax job or a print job is detected while the copier is in one of the energy-saving modes, it will automatically return to a copy-ready state and print out the corresponding job.

Copiers are generally in a standby mode more than they are in actual operation, so power consumption in the standby mode occupies a large part of overall consumption. Having the copier enter a rest state after a certain amount of time, or turning the power completely OFF (O), reduces unnecessary power consumption in the standby mode and as a result can save on electricity bills.

NOTES

- The auto low power function will not engage when the copier is in the sleep mode.
- In order to change the amount of time that will elapse before the auto low power function engages, see "Auto low power time" on page 7-48.
- In order to change the amount of time that will elapse before the auto sleep function engages, see "Auto sleep time" on page 7-47. In order to disable the auto sleep function, see "Auto sleep ON/OFF" on page 7-57.
- If the optional Printer Kit or Printer/Scanner Kit is installed in your copier, the copier will enter the Sleep mode whenever the auto sleep function engages. In this state, when the copier detects data for a print job, it will automatically recover to a print-ready state and print out of the corresponding information will begin.
- If the optional Fax Kit is installed in your copier, the copier will be automatically turned OFF (O) whenever the auto sleep function engages. In this state, when the copier receives an incoming fax, it will automatically recover to a print-ready state and print out of the corresponding information will begin.

Section 5 OTHER CONVENIENT FUNCTIONS

1. Making 2-sided copies from various types of originals [2-sided copy modes]

With these modes, 2-sided copies can be made from a variety of originals including open-faced (books, etc.) or 2-sided originals.

(1) Making 2-sided copies from a 2-sided original

With this mode, a 2-sided original is copied and the front and back sides of the copy paper are used so that the copy looks just like the original.

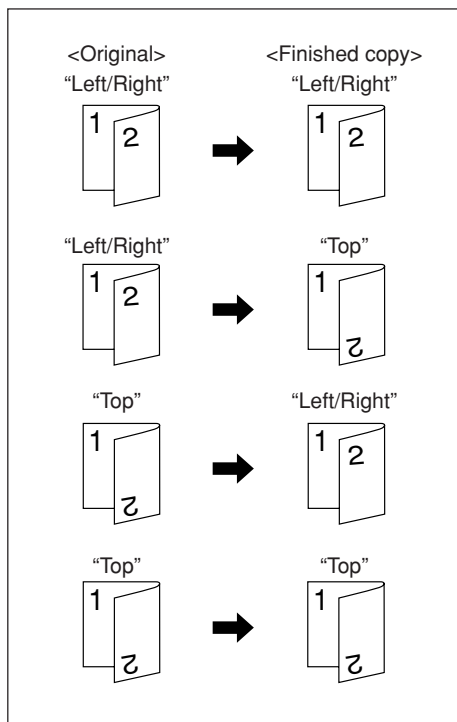

NOTES

- Only paper sizes between 5 1/2" x 8 1/2", 8 1/2" x 11", 11" x 8 1/2", 8 1/2" x 13", 8 1/2" x 14", 11" x 17", A5R, B5R, B5, A4R, A4, B4, A3 and Folio can be used in this mode.
- The Document Processor (option) must be installed on your copier in order to use this mode.

(2) Making 2-sided copies from an open-faced (books, etc.) original

With this mode, the two facing pages of a book or magazine are copied separately onto the front and back sides of the copy paper by simply pressing the [Start] key.

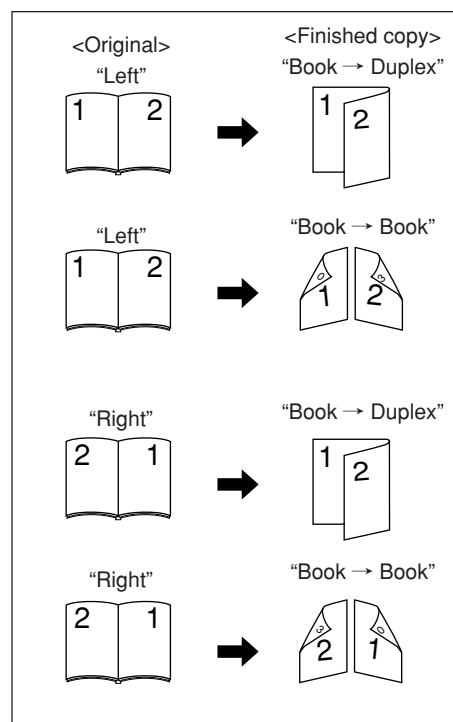

NOTE

Only 8 1/2" x 11", 11" x 17", A5R, B5R, A4R, B4 and A3 size originals can be used in this mode.

Section 5 OTHER CONVENIENT FUNCTIONS

(3) Making 2-sided copies from one-sided originals

With this mode, multiple one-sided originals are copied onto the front and back sides of the copy paper. If you are copying an odd number of originals, the back side of the last copy page will be blank.

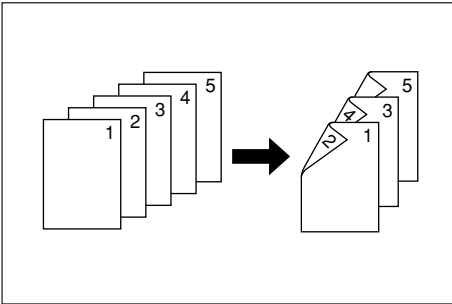

NOTE

The image that is copied onto the back side of the copies can also be rotated 180 degrees.

- ① If you chose the “Left/Right” [“Left/Right binding”] setting for finished copies:

The back side of the copies will be created with the same orientation as the originals.

- ② If you chose the “Top” [“Top binding”] setting for finished copies: The image that is copied onto the back side of the copies will be rotated 180 degrees. If you then bind the copy set at the top, the images will be oriented in the same direction when flipped up like a calendar, etc.

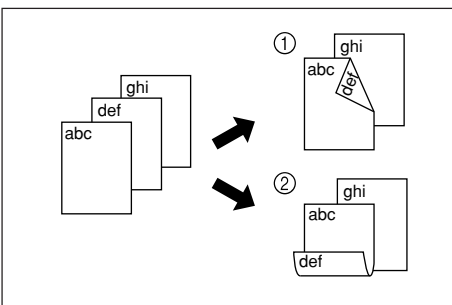

- 1 Set the originals to be copied.

- 2 Touch the “Function” tab. The content of the “Function” tab will be displayed.

Touch the “2 sided/ Separation” [“2-sided/ Split”] key.

The “2 sided/ Separation” [“2-sided/ Split”] screen will be displayed.

Inch specifications

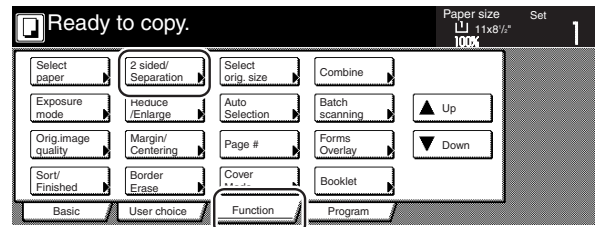

Metric specifications

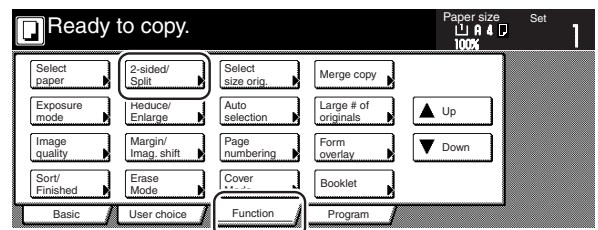

- 3 If you are copying from 2-sided originals, touch the “2 sided → 2 sided” [“2-sided → 2-sided”] key. If you are copying from open-faced originals, touch the “Book → 2 sided” [“Book → 2-sided”] key. If you are copying from 1-sided originals, touch the “1 sided → 2 sided” [“1-sided → 2-sided”] key.

If you selected “2 sided → 2 sided” [“2-sided → 2-sided”] or “Book → 2 sided” [“Book → 2-sided”], go to the next step.

If you selected “1 sided → 2 sided” [“1-sided → 2-sided”], go directly to step 5.

Inch specifications

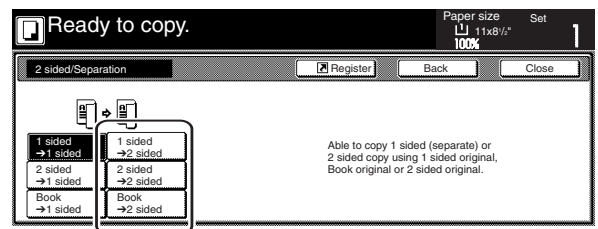

Metric specifications

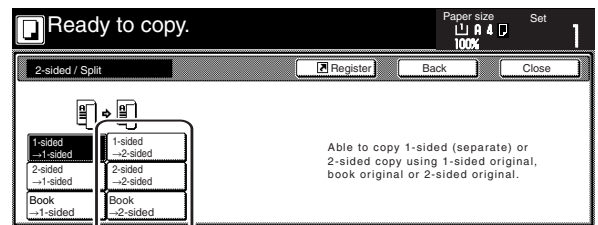

4 Specify the binding direction of the originals.

Inch specifications

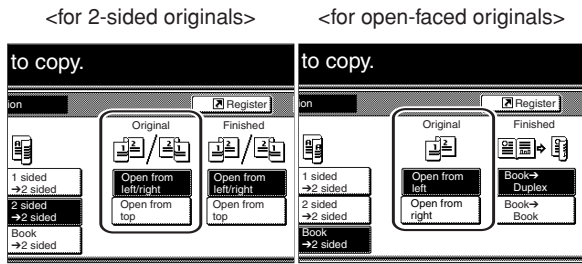

Metric specifications

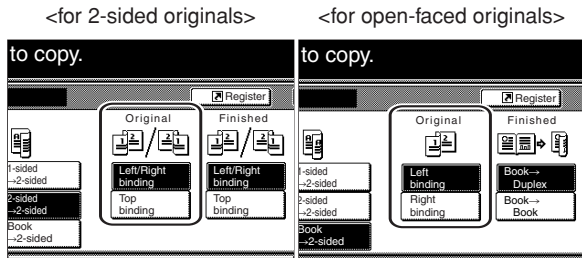

5 Select the binding direction you want for the finished copies.

Inch specifications

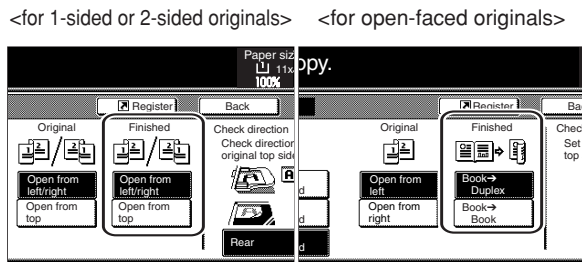

Metric specifications

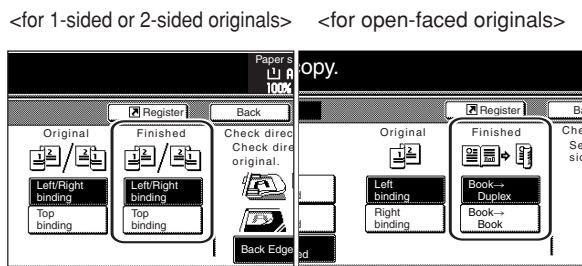

6 Follow the instructions on the right side of the touch panel and verify the direction in which the originals were set.

IMPORTANT!

If the designation for the direction that the originals are set is not correct, copying may be accomplished incorrectly.

Inch specifications

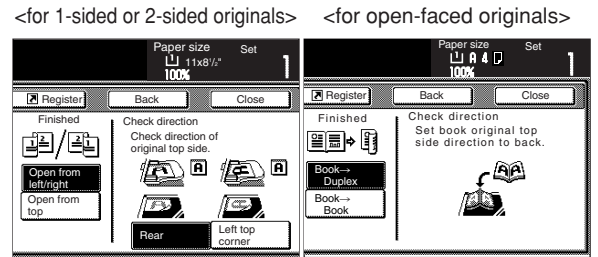

Metric specifications

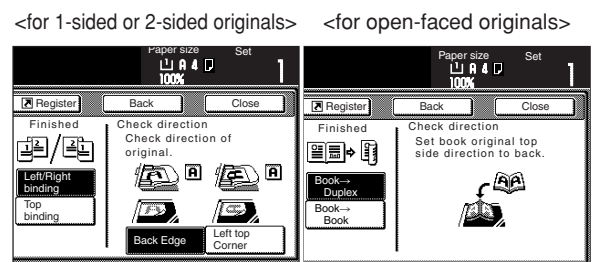

7 Press the [Start] key. Scanning of the originals will start.

If you set the originals in the optional Document Processor, copying will start automatically.

If you set an original on the platen, a message will appear telling you to set the next original. In this case, go to the next step.

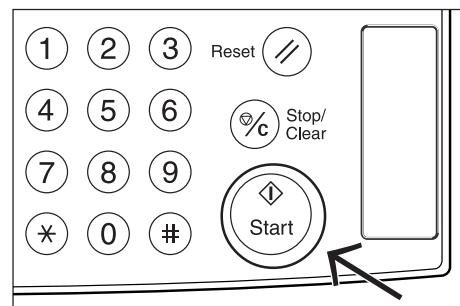

8 Replace the first original with the next one and press the [Start] key. Scanning of that next original will start.

9 Once you have finished scanning all of the originals, touch the "Scanning finished" key. Copying will start.

2. Copying two-page originals onto separate sheets

[Page separation/Split copy modes]

(1) Page separation/Split copy from book originals

With this mode, the two facing pages of an open-faced original such as a book, a magazine, and the like are each copied onto a separate sheet of paper.

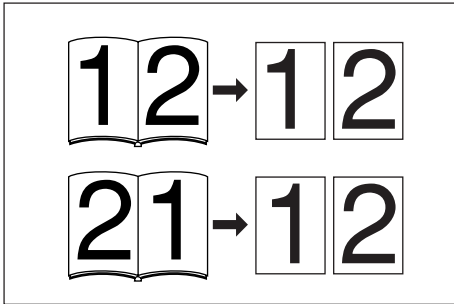

NOTES

Inch specifications

- Only 8 1/2" x 11", 11" x 17", A5R, B5R, A4R, B4 and A3 size originals and 11" x 8 1/2" size copy paper can be used in this mode. Depending upon the size of the originals, the image will be enlarged or reduced to fit the size of the copy paper.

Metric specifications

- Only A5R, B5R, A4R, B4, A3, 8 1/2" x 11" and 11" x 17" size originals and A4 size copy paper can be used in this mode. Depending upon the size of the originals, the image will be enlarged or reduced to fit the size of the copy paper.

Metric specifications (Asia Pacific)

- Only A5R, B5R, A4R, B4, A3, 8 1/2" x 11" and 11" x 17" size originals and B5 or A4 size copy paper can be used in this mode. Depending upon the size of the originals, the image will be enlarged or reduced to fit the size of the copy paper.

(2) Page separation/Split copy from 2-sided originals

With this mode, the two sides of a 2-sided original are each copied onto a separate sheet of paper.

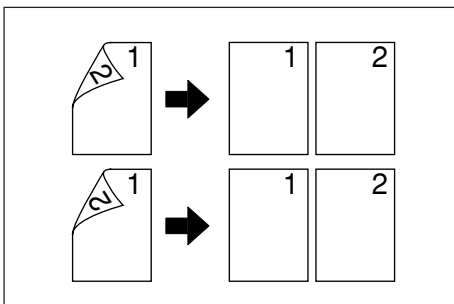

NOTE

The Document Processor (option) must be installed on your copier in order to use this mode.

1 Set the originals to be copied.

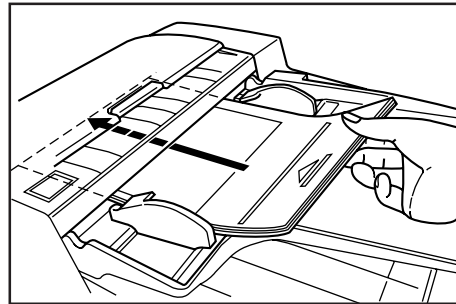

2 Touch the "Function" tab. The content of the "Function" tab will be displayed.

3 Touch the "2 sided/Separation" ["2-sided/Split"] key. The "2 sided/Separation" ["2-sided/Split"] screen will be displayed.

Inch specifications

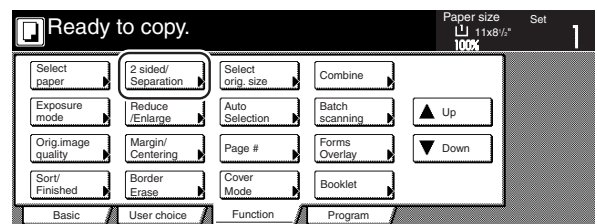

Metric specifications

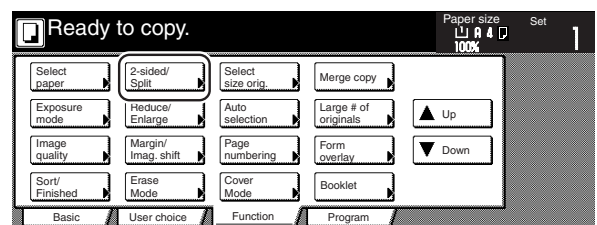

- Touch the “2 sided → 1 sided” [“2-sided → 1-sided”] key or the “Book → 1 sided” [“Book → 1-sided”] key, as appropriate to the type of originals being copied and the type of finished copies to be made.

Inch specifications

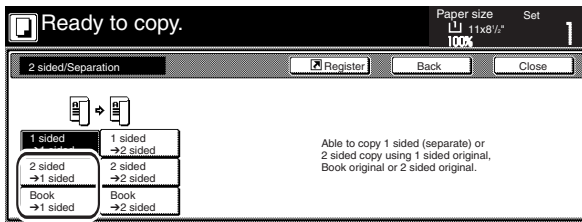

Metric specifications

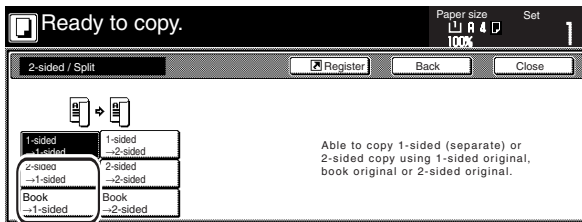

- Specify the binding direction of the originals.

Inch specifications

<for 2-sided originals> <for open-faced originals>

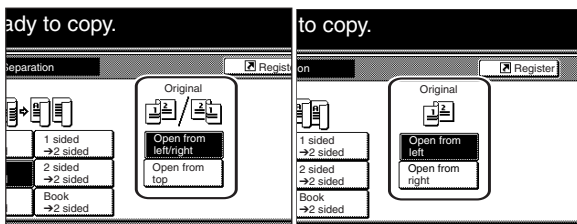

Metric specifications

<for 2-sided originals> <for open-faced originals>

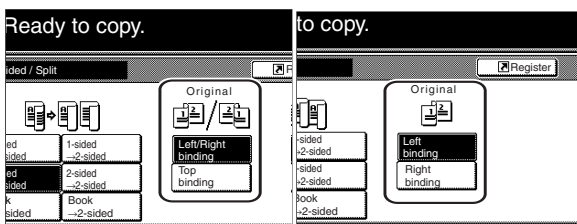

- Follow the instructions on the right side of the touch panel and verify the direction in which the originals were set.

IMPORTANT!

If the designation for the direction that the originals are set is not correct, copying may be accomplished incorrectly.

Inch specifications

<for 1-sided or 2-sided originals> <for open-faced originals>

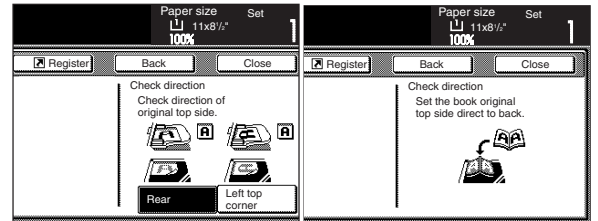

Metric specifications

<for 1-sided or 2-sided originals> <for open-faced originals>

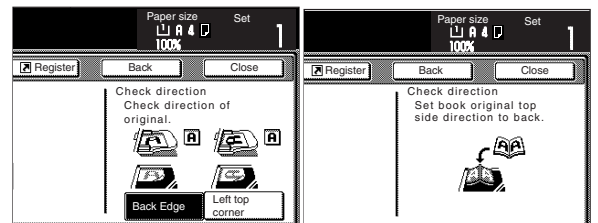

- Press the [Start] key. Scanning of the originals will start.

If you set the originals in the optional Document Processor, copying will start automatically.

If you set an original on the platen, a message will appear telling you to set the next original. In this case, go to the next step.

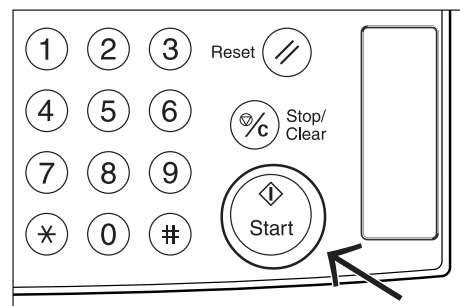

- Replace the first original with the next one and press the [Start] key. Scanning of that next original will start.

- Once you have finished scanning all of the originals, touch the “Scanning finished” key. Copying will start.

3. Making a margin space on the copies [Margin mode]

(1) Standard margin

Inch specifications

The image of the original can be shifted to the left or right and up or down to make a margin (blank) space on the copy. The width of each margin can be set to any 1/8" increment between 1/8" and 3/4".

A setting of "0" will leave no margin space.

Metric specifications

The image of the original can be shifted to the left or right and up or down to make a margin (blank) space on the copy. The width of each margin can be set to any 1 mm increment between 1 mm and 18 mm.

A setting of "0" will leave no margin space.

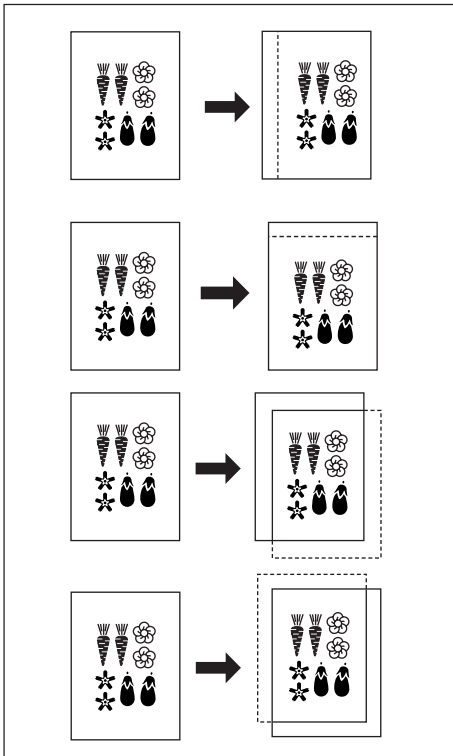

(2) Separate front and back margin settings

Inch specifications

When you are making 2-sided copies, the margin positions and widths can be selected separately for the front and back sides. The width of each margin can be set to any 1/8" increment between 1/8" and 3/4".

A setting of "0" will leave no margin space.

Metric specifications

When you are making 2-sided copies, the margin positions and widths can be selected separately for the front and back sides. The width of each margin can be set to any 1 mm increment between 1 mm and 18 mm. A setting of "0" will leave no margin space.

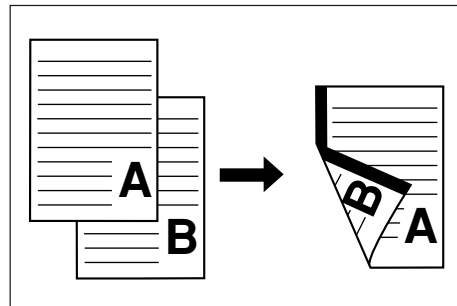

- 1 Set the originals to be copied.

IMPORTANT!

Set originals so that the top edge is facing either the back or the left of the copier. Setting them in the wrong direction may cause the margin to be created in the incorrect position.

- 2 Touch the "Function" tab. The content of the "Function" tab will be displayed.
- 3 Touch the "Margin/Centering" ["Margin/Imag.shift"] key. The "Margin/Centering" ["Margin/Image shift"] screen will be displayed.

Inch specifications

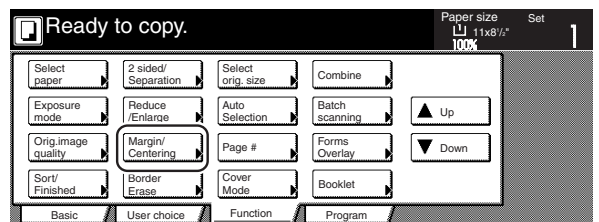

Metric specifications

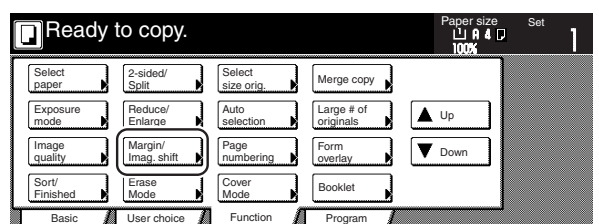

NOTES

- It is also possible for you to select the default setting for the location and width of the margins. (See "Margin width" on page 7-80.)
- If you select to have a left margin created during 2-sided copying and the location for the back side margin is set to "Auto", a right margin that is the same width as the margin on the front side will be automatically created on the back side of the copies.

- 4 Touch the “Margin” key. The screen to set the front side margin will be displayed.

Inch specifications

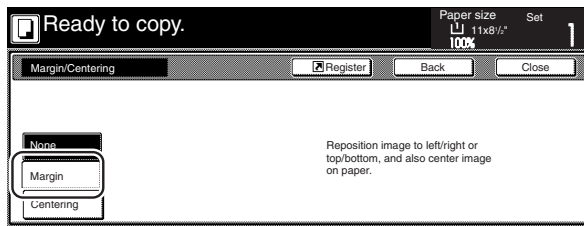

Metric specifications

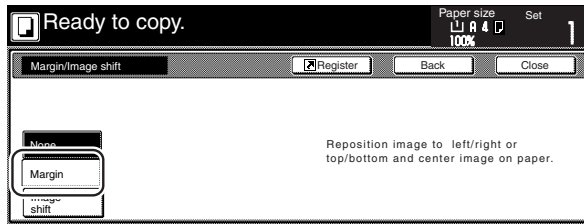

- 5 Use the up/down and left/right cursor keys to select the desired location and width of each margin.

Inch specifications

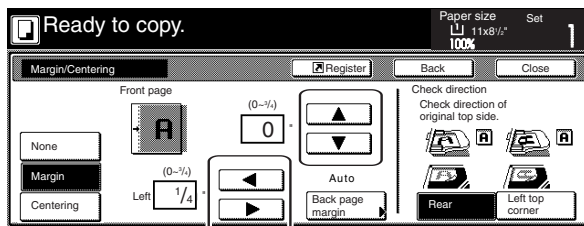

Metric specifications

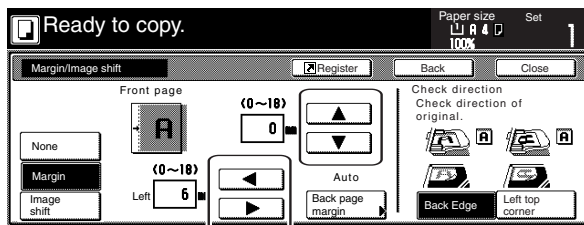

- 6 If you are making 2-sided copies, touch the “Back page margin” key. The “Back page margin” screen will be displayed.

Inch specifications

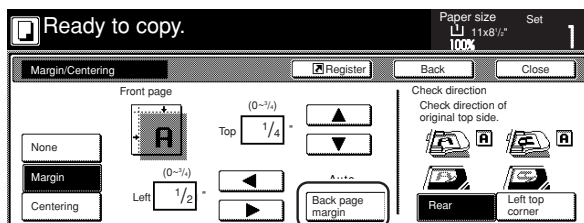

Metric specifications

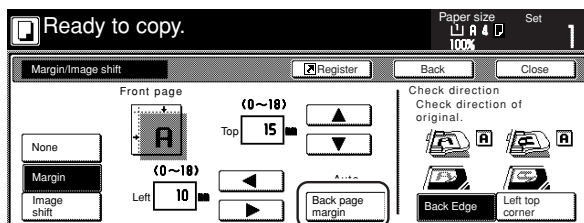

- 7 If you want to create a margin on the back side of the copies that lines up with that on the front side, touch the “Auto” key. If you want to set the margins for the front and back sides separately, touch the “Front/Back margin” key. The screen to set the back side margin will be displayed.

Inch specifications

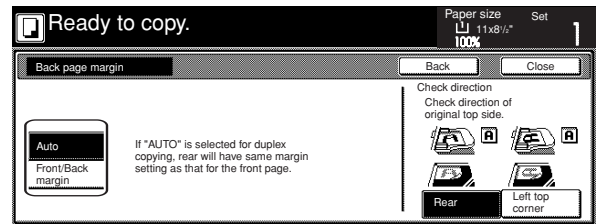

Metric specifications

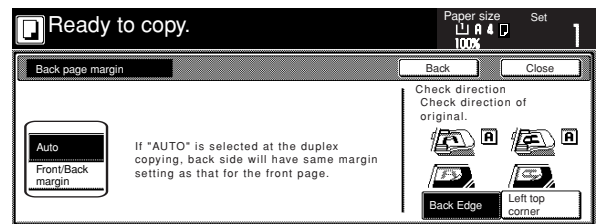

- 8 Use the up/down and left/right cursor keys to select the desired location and width of each margin.

Inch specifications

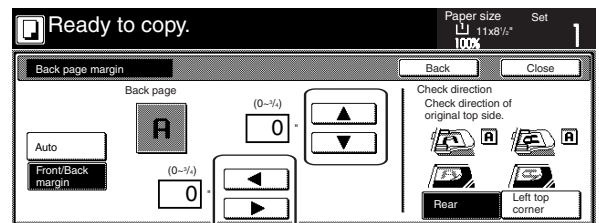

Metric specifications

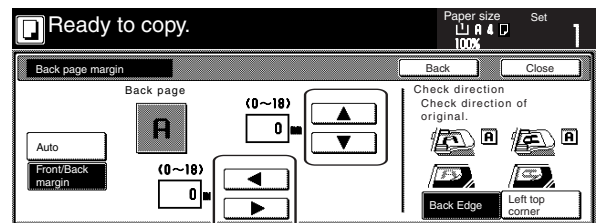

- 9 Follow the instructions on the right side of the touch panel and verify the direction in which the originals were set.

IMPORTANT!

If the designation for the direction that the originals are set is not correct, copying may be accomplished incorrectly.

- 10 Press the [Start] key. Copying will start.

4. Centering the copy image [Centering/Image shift mode]

With this mode you can center the image on the copy paper when you copy onto a paper size that is larger than that of the original.

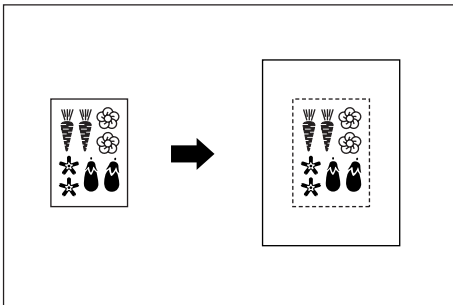

- 1 Set the originals to be copied.

IMPORTANT!

Set originals so that the top edge is facing either the back or the left of the copier. Setting them in the wrong direction may cause the image to be copied in the incorrect position.

- 2 Touch the “Function” tab. The content of the “Function” tab will be displayed.

- 3 Touch the “Margin/Centering” [“Margin/Imag.shift”] key. The “Margin/Centering” [“Margin/Image shift”] screen will be displayed.

Inch specifications

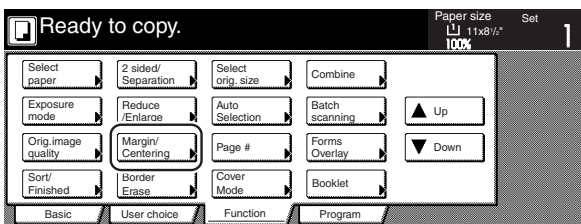

Metric specifications

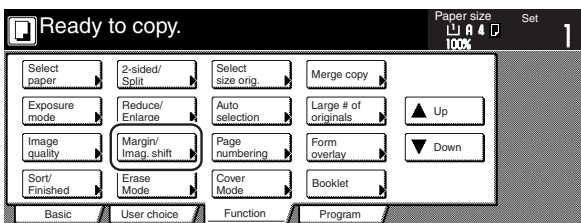

- 4 Touch the “Centering” [“Imag.shift”] key.

Inch specifications

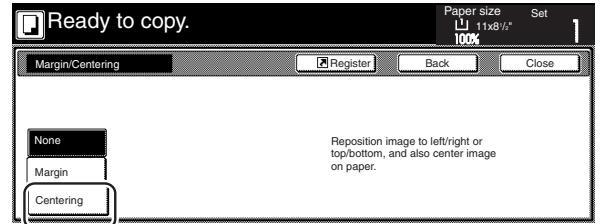

Metric specifications

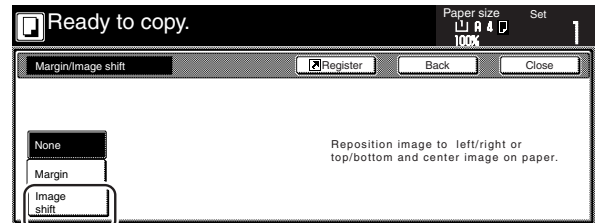

- 5 Follow the instructions on the right side of the touch panel and verify the direction in which the originals were set.

Inch specifications

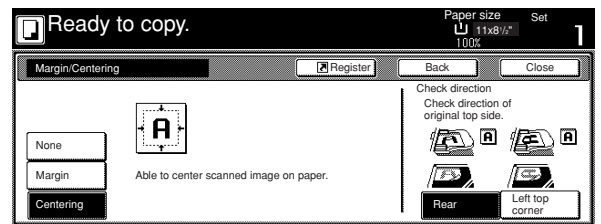

Metric specifications

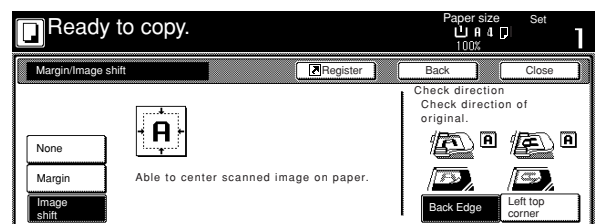

IMPORTANT!

If the designation for the direction that the originals are set is not correct, copying may be accomplished incorrectly.

- 6 Press the [Start] key. Copying will start.

5. Adding a space next to the copy images for making notes [Memo mode]

With this mode you can leave a space for adding notes next to the copied image. It is also possible to fit the images of 2 originals onto the same copy page along with a blank space for each.

- Copying one original onto one copy page (layout A)

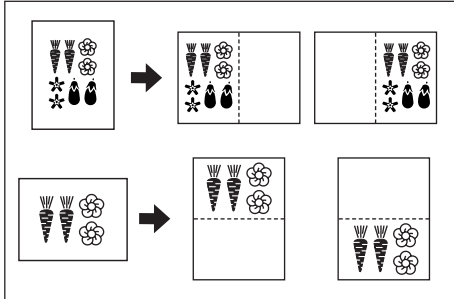

- Copying two originals onto one copy page (layout B)

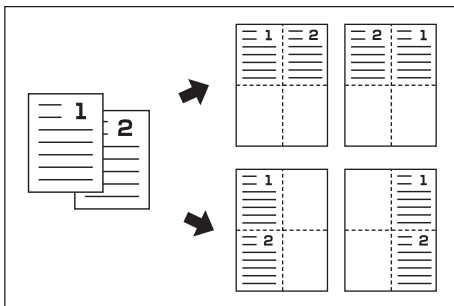

NOTE

Only 8 1/2" x 11", 11" x 8 1/2", 11" x 17", B5R, B5, A4R, A4, B4 and A3 size copy paper can be used in this mode.

- 1 Set the originals to be copied.
- 2 Touch the "Function" tab and then the "▼ Down" key. The content of the next portion of the "Function" tab will be displayed.
- 3 Touch the "Memo pages" key. The "Memo pages" screen will be displayed.

Inch specifications

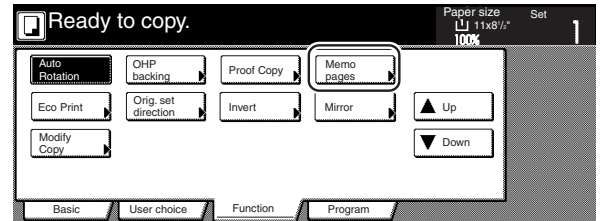

Metric specifications

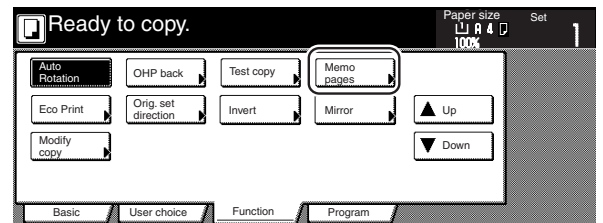

- 4 Touch the "Layout A" key or the "Layout B" key, as appropriate. The screen to make the layout settings will be displayed.

Inch specifications

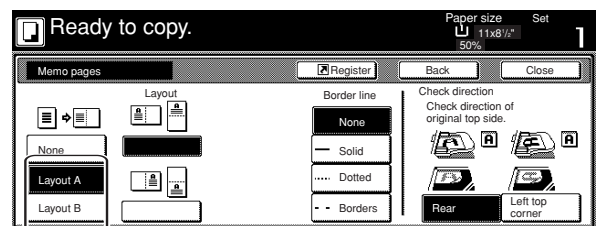

Metric specifications

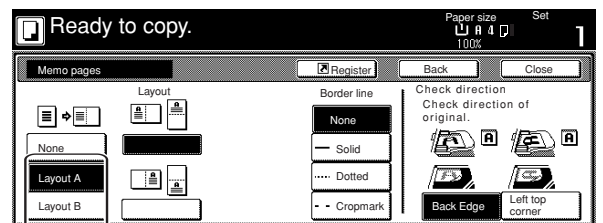

Section 5 OTHER CONVENIENT FUNCTIONS

5 Select the desired direction of the layout.

Inch specifications

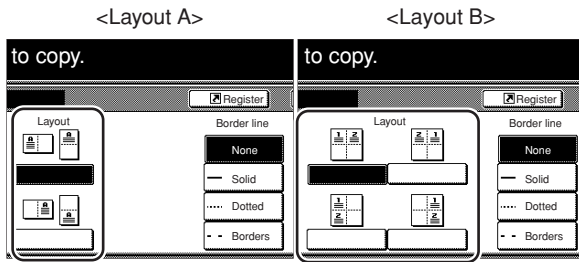

Metric specifications

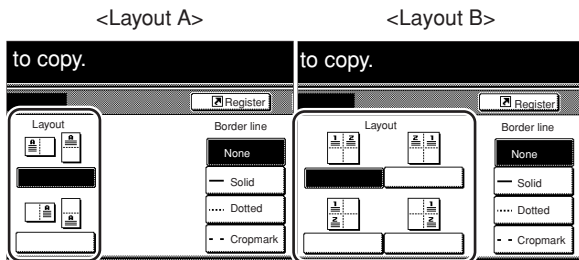

6 Select the type of the borderline that you want to use to separate the different areas.

7 Press the [Start] key. Scanning of the originals will start.

If you set the originals in the optional Document Processor, copying will start automatically.

If you set an original on the platen, a message will appear telling you to set the next original. In this case, go to the next step.

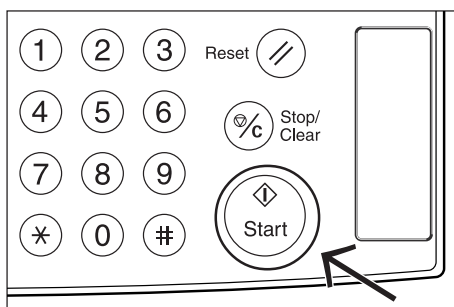

8 Replace the first original with the next one and press the [Start] key. Scanning of that next original will start.

9 Once you have finished scanning all of the originals, touch the "Scanning finished" key. Copying will start.

6. Making copies with clean edges [Border erase modes]

(1) Erasing blemishes from edges of copies (Sheet erase mode)

Inch specifications

With this mode, shadows, lines, etc., that occur around the edges of copies made from sheet originals can be erased. A border of equal width will be erased around all sides of the copied image. The width of the border to be erased can be set to any 1/8" increment between 1/8" and 3/4". A setting of "0" will result in no border being erased. (The areas that will be erased are shown as (a) in the illustration.)

Metric specifications

With this mode, shadows, lines, etc., that occur around the edges of copies made from sheet originals can be erased. A border of equal width will be erased around all sides of the copied image. The width of the border to be erased can be set to any 1 mm increment between 1 mm and 18 mm. A setting of "0" will result in no border being erased. (The areas that will be erased are shown as (a) in the illustration.)

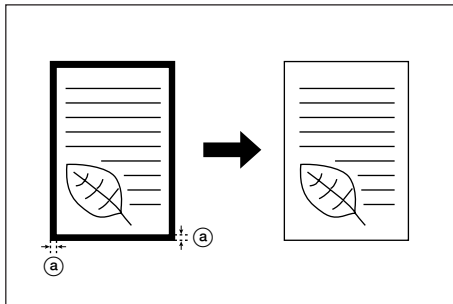

NOTE

It is possible for you to change the default setting for the width of the erased border. (See "Erased border width" on page 7-81.)

(2) Erasing blemishes from the edges and middle of copies made from books (Book erase mode)

Inch specifications

With this mode, you can make clean copies, even from thick books. The width of the outside border to be erased can be set to any 1/8" increment between 1/8" and 3/4". The width of the center area to be erased can be set to any 1/8" increment between 1/8" and 1 1/2". A setting of "0" will result in no border being erased.

(The area that will be erased as the outside border is shown as (a) in the illustration, while that of the center area is shown as (b).)

Metric specifications

With this mode, you can make clean copies, even from thick books. The width of the outside border to be erased can be set to any 1 mm increment between 1 mm and 18 mm. The width of the center area to be erased can be set to any 1 mm increment between 1 mm and 36 mm. A setting of "0" will result in no border being erased.

(The area that will be erased as the outside border is shown as (a) in the illustration, while that of the center area is shown as (b).)

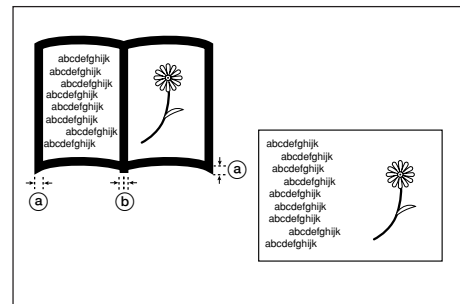

NOTE

It is possible for you to change the default setting for the width of the erased borders. (See "Erased border width" on page 7-81.)

Section 5 OTHER CONVENIENT FUNCTIONS

(3) Erasing blemishes from the edges of copies using individual border settings (Individual border erase mode)

Inch specifications

With this mode, shadows, lines, etc., that occur around the edges of copies made from sheet originals can be erased, but in this case you can designate separate widths for each of the top, bottom, left and right borders. The width of each border to be erased can be set to any 1/8" increment between 0 and 2".

(The area that will be erased as the top border is shown as (a), the bottom border is shown as (b), the left border as (c), and the right border as (d), in the illustration.)

Metric specifications

With this mode, shadows, lines, etc., that occur around the edges of copies made from sheet originals can be erased, but in this case you can designate separate widths for each of the top, bottom, left and right borders. The width of each border to be erased can be set to any 1 mm increment between 0 and 50 mm.

(The area that will be erased as the top border is shown as (a), the bottom border is shown as (b), the left border as (c), and the right border as (d), in the illustration.)

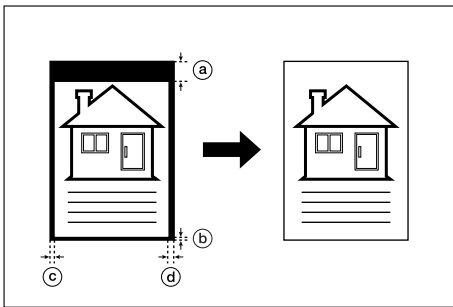

NOTE

The default settings for the border widths are the same values as that set for the sheet erase mode.

- 1 Set the original to be copied.

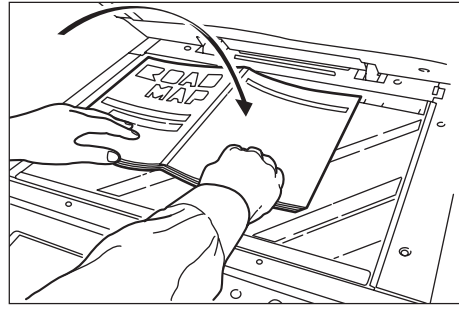

- 2 Touch the "Function" tab. The content of the "Function" tab will be displayed.

- 3 Touch the "Border Erase" ["Erase Mode"] key. The "Border Erase" ["Erase Mode"] screen will be displayed.

Inch specifications

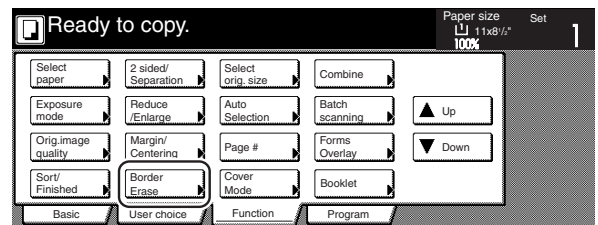

Metric specifications

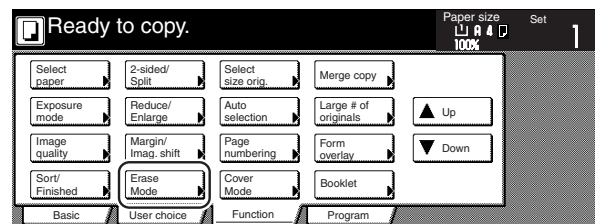

If you want to select the sheet erase mode or the book erase mode, go to the next step.

If you want to select the individual border erase mode, go directly to step 6.

- 4** Touch the “Sheet Erase” [“Border erase”] key or the “Book Erase” key, as appropriate. The screen to set the outside border and the center area will be displayed.

Inch specifications

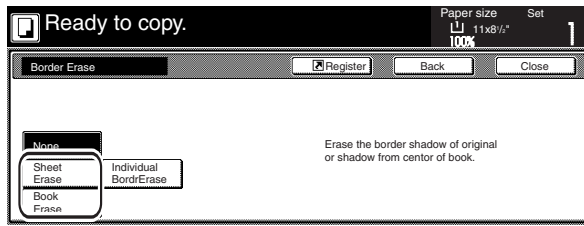

Metric specifications

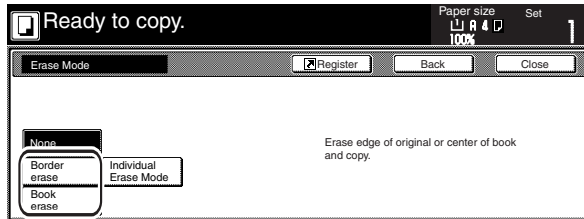

- 5** Touch the “+” key or the “-” key to change the displayed border width to that desired.
 * In metric specification copiers, the desired border width can also be entered directly by touching the “#-Keys” key and then using the keypad.

Inch specifications

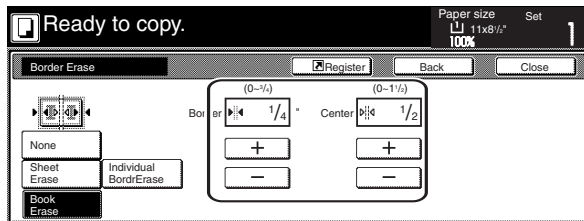

Metric specifications

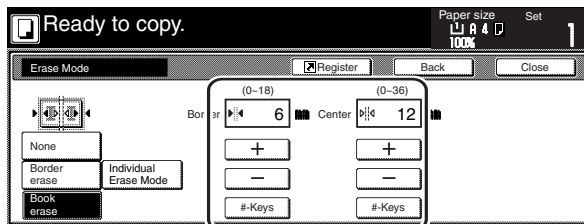

Go directly to step 10.

- 6** Touch the “Individual BordenErase” [“Individual Erase Mode”] key. The screen to set the top, bottom, left or right border will be displayed.

Inch specifications

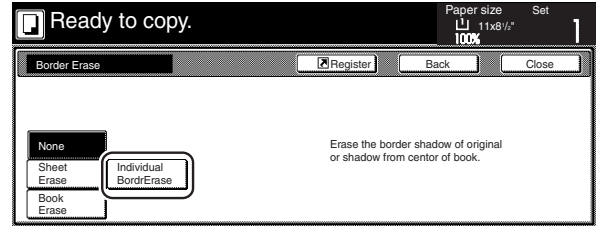

Metric specifications

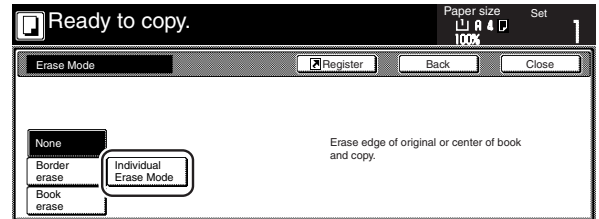

- 7** Touch the key that corresponds to the border whose width you want to change. The screen to set that border width will be displayed.

Inch specifications

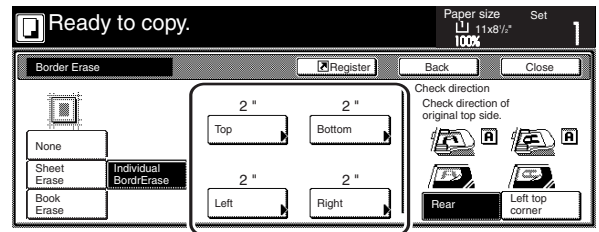

Metric specifications

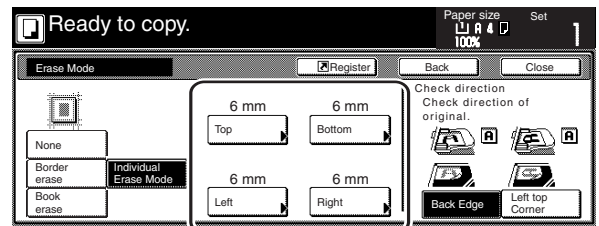

Section 5 OTHER CONVENIENT FUNCTIONS

- 8 Touch the “+” key or the “-” key to change the displayed border width to that desired.

* In metric specification copiers, the desired border width can also be entered directly by touching the “#-Keys” key and then using the keypad.

Inch specifications

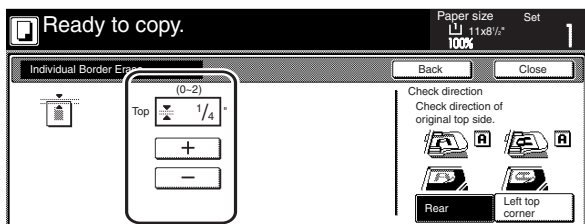

Metric specifications

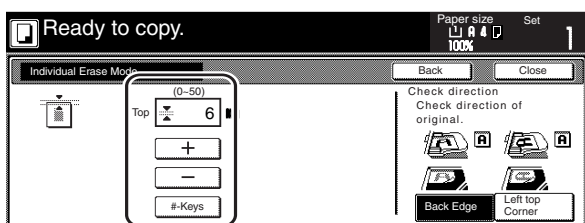

- 9 Touch the “Close” key. The touch panel will return to the screen in step 7.
If you want to change the width of any of the other borders, repeat steps 7 through 9.

- 10 Press the [Start] key.
Copying will start.

7. Fitting the image of either two or four originals onto a single copy page [Combine/Merge Copy modes]

With this mode, the images from either 2 or 4 originals can be reduced and then combined onto a single copy. The borderline of each original can also be marked with either a solid line or a dotted line.

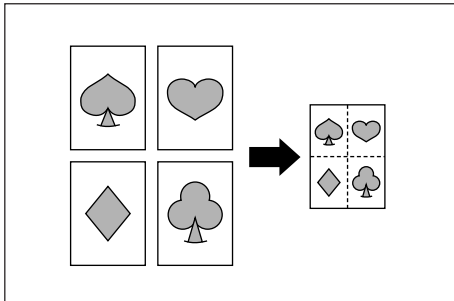

NOTE

Only 8 1/2" x 11", 11" x 8 1/2", 11" x 17", B5R, B5, A4R, A4, B4 and A3 size copy paper can be used in this mode.

(1) 2 in 1

Use this mode when you want to copy two originals onto one sheet. This mode can also be used in conjunction with the 2-sided copy modes in order to copy four originals onto one sheet. (When setting the originals on the platen, be sure to set the originals in the correct order: 1 and then 2.)

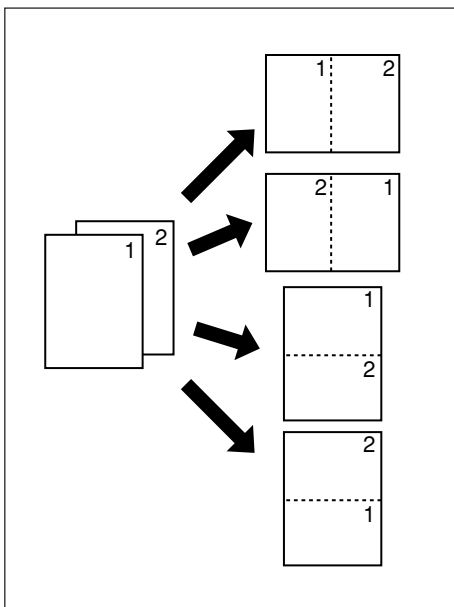

(2) 4 in 1

Use this mode when you want to copy four originals onto one sheet. This mode can also be used in conjunction with the 2-sided copy modes in order to copy eight originals onto one sheet. (When setting the originals on the platen, be sure to set the originals in the correct order: 1, 2, 3 and then 4.)

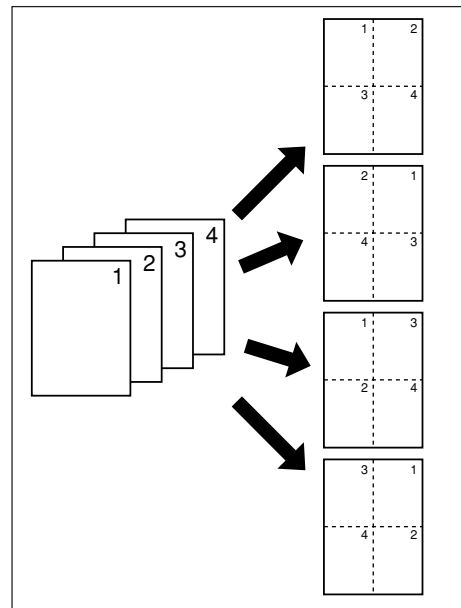

Section 5 OTHER CONVENIENT FUNCTIONS

1 Set the originals to be copied.

2 Touch the “Function” tab. The content of the “Function” tab will be displayed.

Inch specifications

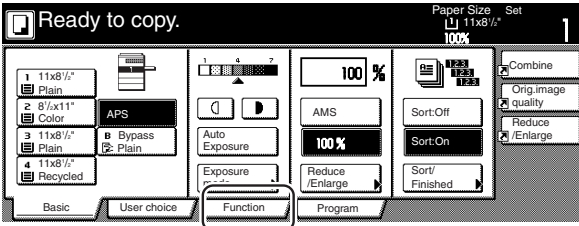

Metric specifications

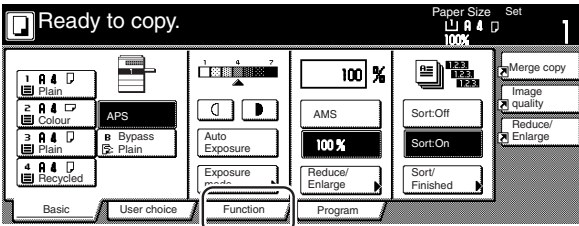

3 Touch the “Combine” [“Merge copy”] key. The “Combine” [“Merge copy”] screen will be displayed.

Inch specifications

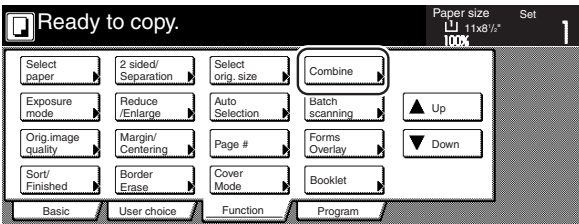

Metric specifications

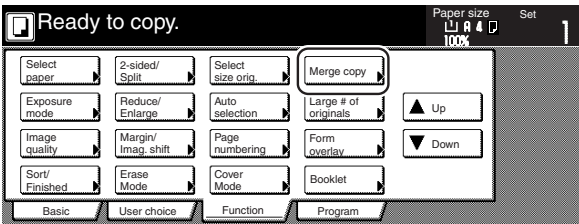

4 Touch the “2 in 1” [“2-in-1”] key or the “4 in 1” [“4-in-1”] key, as appropriate.

The screen to make the layout settings will be displayed.

Inch specifications

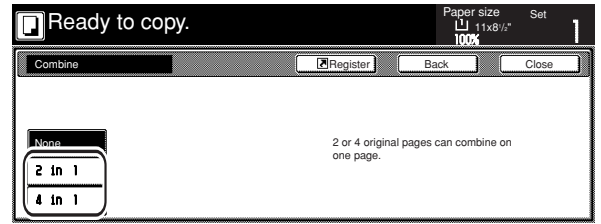

Metric specifications

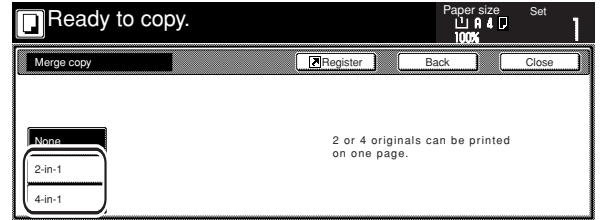

5 Select the desired direction of the layout.

Inch specifications

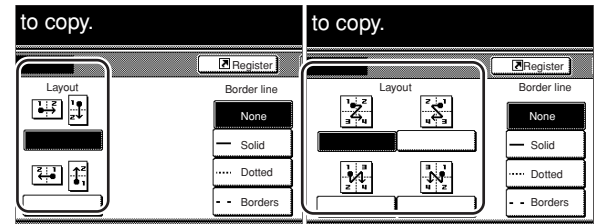

Metric specifications

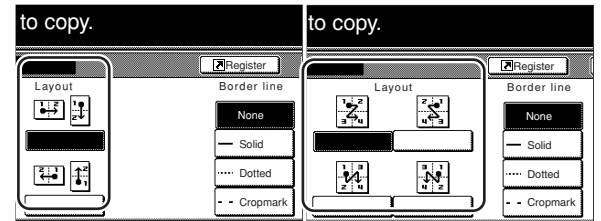

6 Select the type of the borderline that you want to use to separate the images.

- 7 Press the [Start] key.
Scanning of the originals will start.

If you set the originals in the optional Document Processor, copying will start automatically.
If you set an original on the platen, a message will appear telling you to set the next original. In this case, go to the next step.

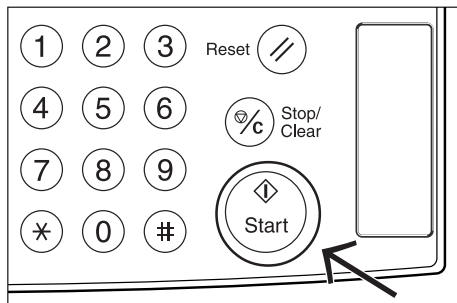

- 8 Replace the first original with the next one and press the [Start] key. Scanning of that next original will start.
- 9 Once you have finished scanning all of the originals, touch the "Scanning finished" key. Copying will start.

8. Printing page numbers on copies [Print page numbers mode]

When you make copies from multiple originals, you can have page numbers printed on the corresponding copies in numerical order from the first original. There are three styles of page numbers to choose from: “-1-”, “P.1” and “1/n”.

* If you select “1/n” as the style of page numbers, the denominator will indicate the total number of pages.

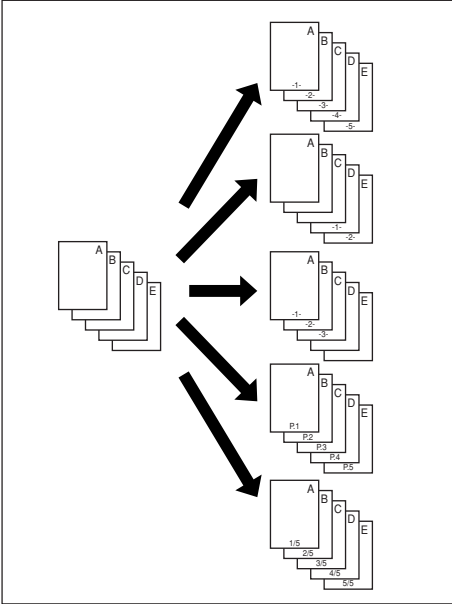

3 Touch the “Page #” [“Page numbering”] key. The “Page #” [“Page numbering”] screen will be displayed.

Inch specifications

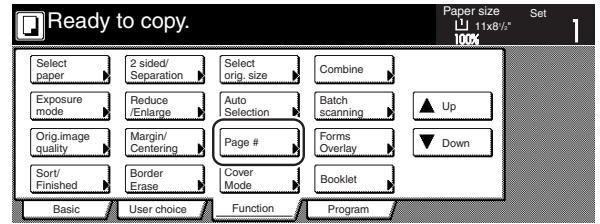

Metric specifications

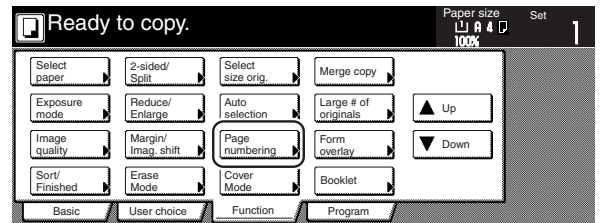

4 Touch the key that corresponds to the style of page numbers that you want to use. The screen to make settings for that style will be displayed.

Inch specifications

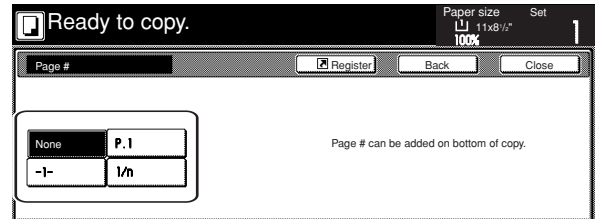

Metric specifications

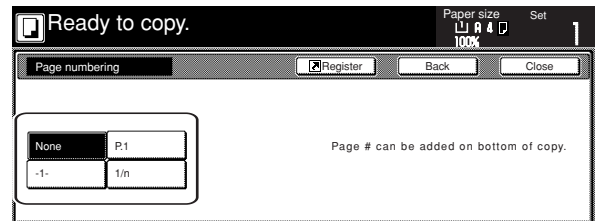

NOTE

Page numbers will be printed relative to the middle of the bottom of the page. (The arrow in the illustration indicates the direction in which the originals are set.)

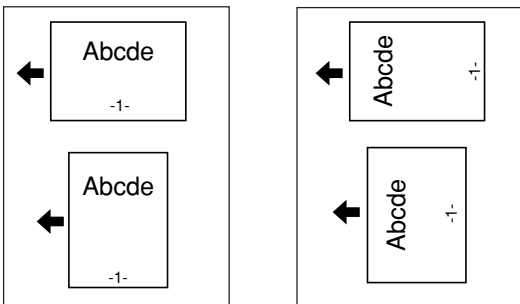

1 Set the originals to be copied.

2 Touch the “Function” tab. The content of the “Function” tab will be displayed.

Section 5 OTHER CONVENIENT FUNCTIONS

- 5** If you want printing of the page numbers to be started from a page other than the first page, touch the “Setting 1st page” key.

The “Setting 1st page” screen will be displayed.

Inch specifications

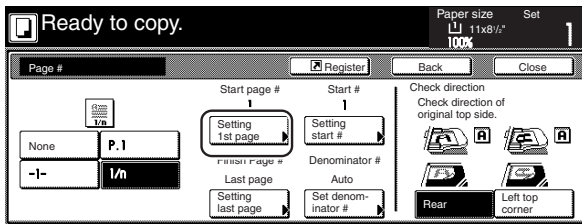

Metric specifications

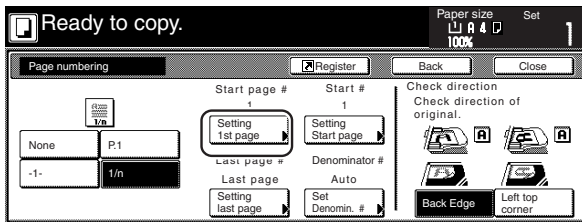

- 6** Touch the “+” key or the “-” key to select from which page printing of the page numbers will start.

Inch specifications

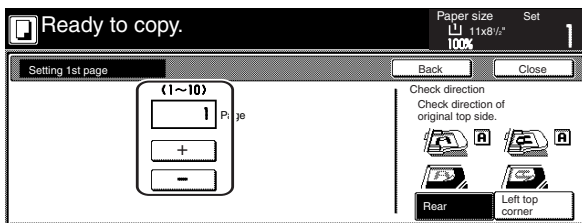

Metric specifications

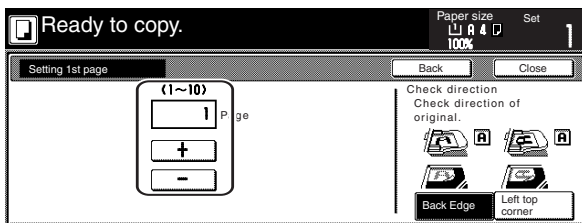

- 7** Touch the “Close” key. The touch panel will return to the screen in step 5.

- 8** If you want the first page number that is printed to be something other than “1”, touch the “Setting start #” [“Setting Start page”] key. The “Setting start #” screen will be displayed.

Inch specifications

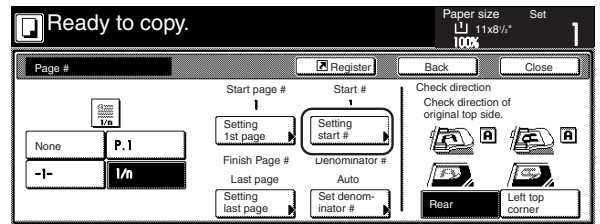

Metric specifications

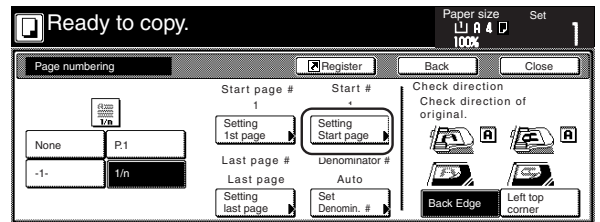

- 9** Touch the “+” key or the “-” key to select the first page number that will be printed.

* The desired page number can also be entered directly by touching the “# keys” [“#-Keys”] key and then using the keypad.

Inch specifications

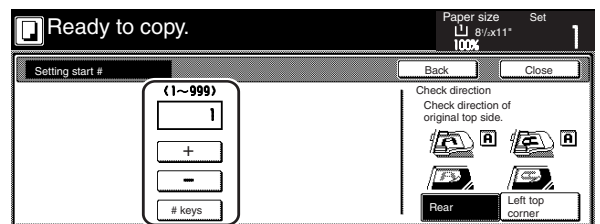

Metric specifications

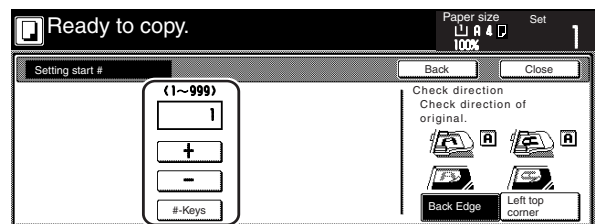

- 10** Touch the “Close” key. The touch panel will return to the screen in step 8.

Section 5 OTHER CONVENIENT FUNCTIONS

- 11** If you want the last page number that is printed to be on a copy other than that for the last original, touch the “Setting last page” key. The “Setting last page” screen will be displayed.

Inch specifications

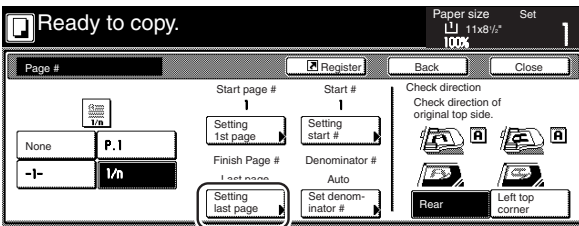

Metric specifications

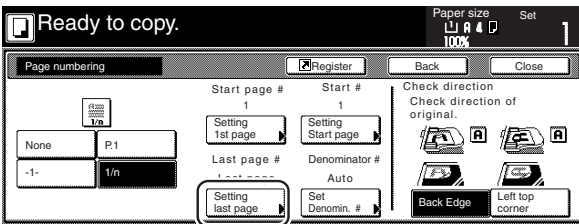

- 12** Touch the “Manual” key. The screen to designate the last page will be displayed.

Inch specifications

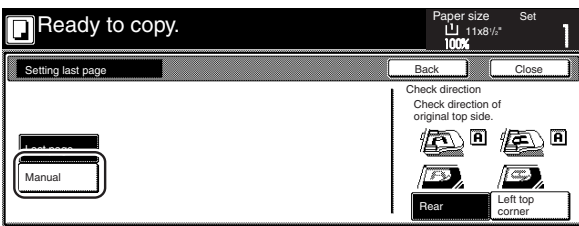

Metric specifications

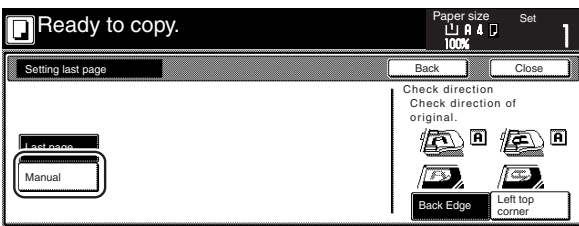

- 13** Touch the “+” key or the “-” key to select, counting from the final copy, how many pages you do NOT want to have page numbers printed on.

Inch specifications

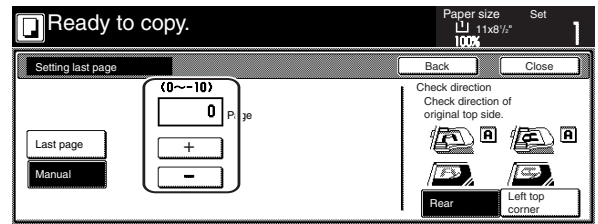

Metric specifications

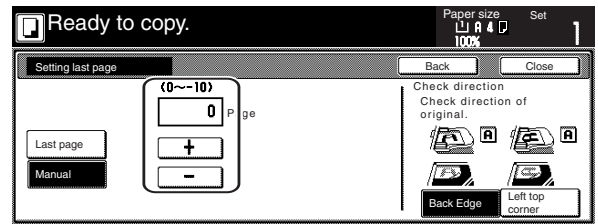

- 14** Touch the “Close” key. The touch panel will return to the screen in step 11. If you selected the “1/n” style, the “Set denominator #” [“Set Denomin. #”] key will be displayed.

- 15** If you want to manually select the denominator for the page numbers, touch the “Set denominator #” [“Set Denomin. #”] key. The “Setting denominator #” screen will be displayed.

Inch specifications

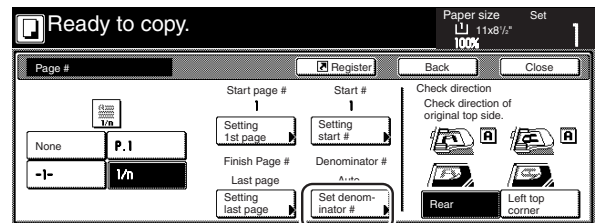

Metric specifications

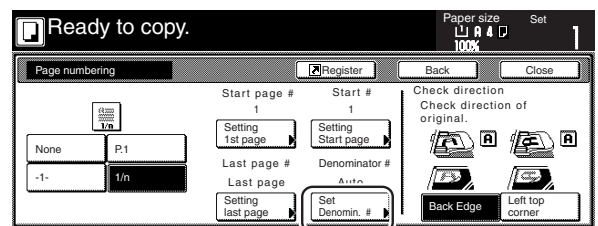

- 16** Touch the “Manual” key.
The screen to designate the denominator will be displayed.

Inch specifications

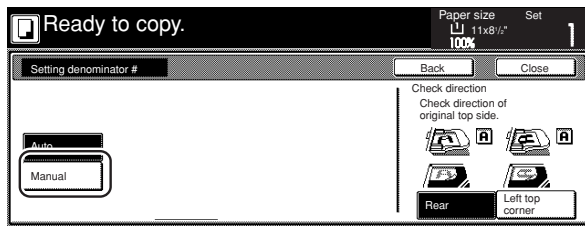

Metric specifications

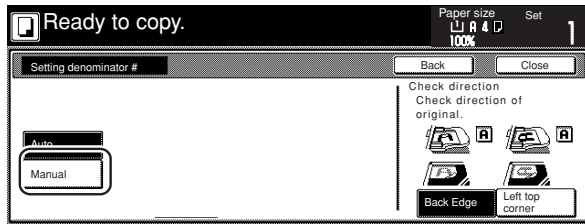

- 17** Touch the “+” key or the “-” key to select the desired denominator for the page numbers.
* The desired denominator can also be entered directly by touching the “# keys” [“#-Keys”] key and then using the keypad.

Inch specifications

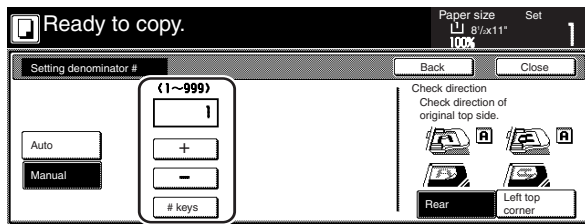

Metric specifications

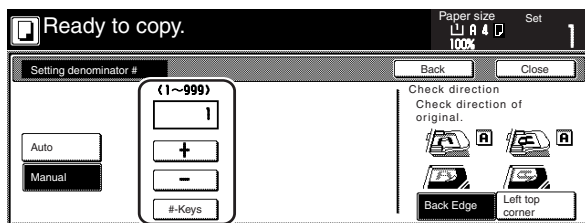

- 18** Follow the instructions on the right side of the touch panel and verify the direction in which the originals were set.

Inch specifications

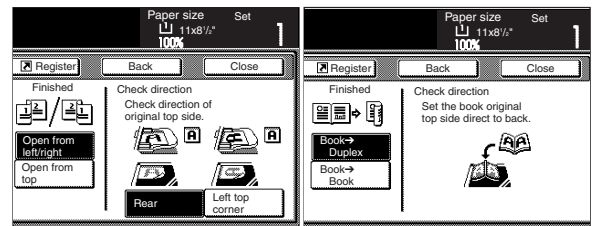

Metric specifications

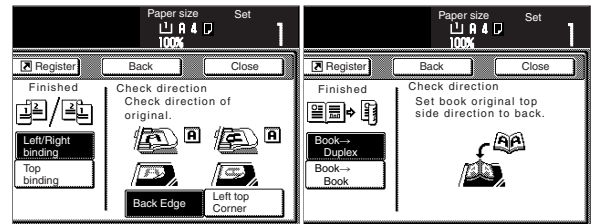

- 19** Press the [Start] key.
Copying will start.

9. Overlaying one image over another [Form overlay mode]

This mode can be used to scan the first original (the “form”) into memory and have its image overlaid onto copies made from subsequent originals. If the optional Hard Disk is installed on your copier, it is also possible to register and store in memory, in advance, the images that you want to use as original forms.

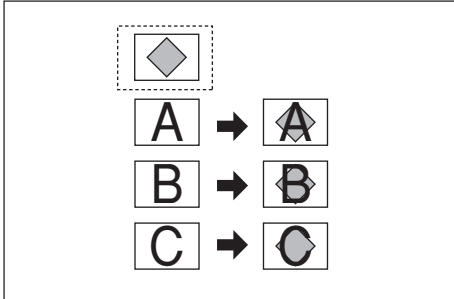

NOTE

Refer to “(2) Form registration” on page 6-1 for the procedure to register images as forms.

1 Touch the “Function” tab. The content of the “Function” tab will be displayed.

2 Touch the “Forms Overlay” [“Form overlay”] key. The “Forms Overlay” [“Form overlay”] screen will be displayed.

Inch specifications

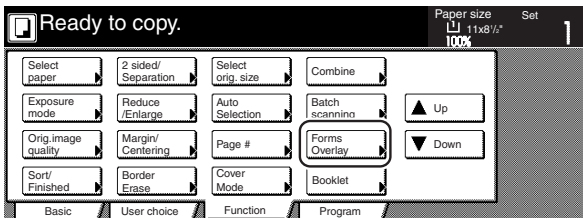

Metric specifications

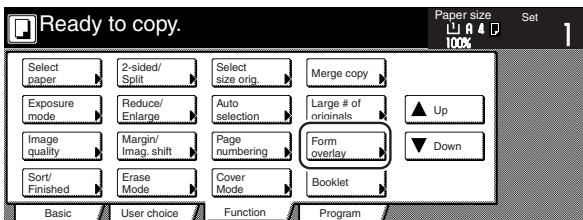

3 Touch the “On” key. The screen to set the shading level of the form image will be displayed.

Inch specifications

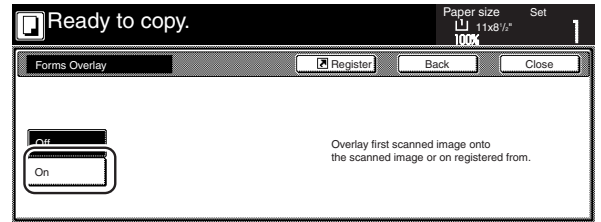

Metric specifications

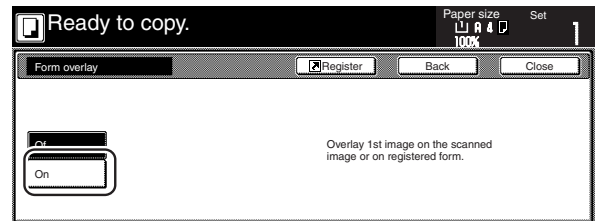

4 Touch the “+” key or the “-” key to select the level of shading that you want to use for the original form.

The desired shading level can be set to any 10% increment between 10% and 100%.

* A sample of the effect that the selected shading level will produce will be displayed to the right of the entry field.

Inch specifications

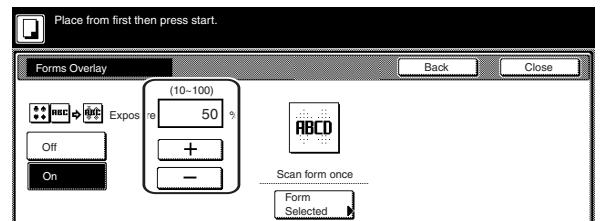

Metric specifications

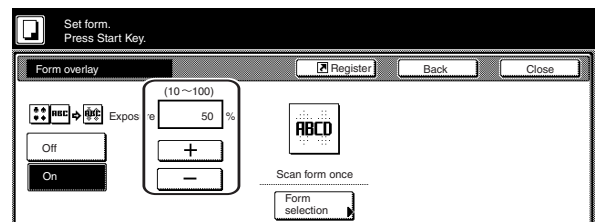

5 If the optional Hard Disk is installed on your copier, it is also possible to register and store in memory, in advance, the images that you want to use as original forms. If you want to use a previously registered image as the form, touch the “Form Selected” [“Form selection”] key and go to the next step.

If you want to scan in a new image, go directly to step 9.

- 6** Touch the “Loading Form” key.
A list of registered forms will be displayed.

Inch specifications

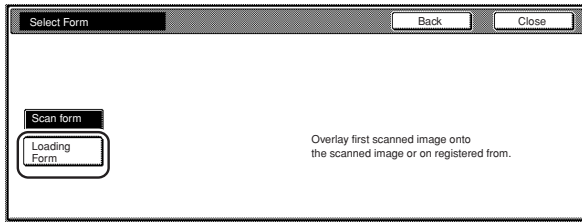

Metric specifications

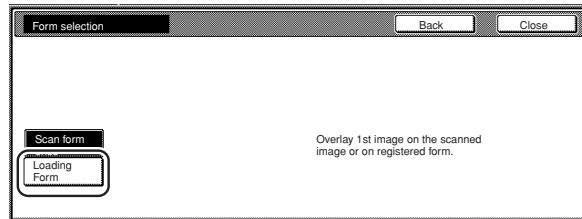

- 7** Select from that list the image that you want to use and then touch the “Close” key. The touch panel will return to the screen in step 4.

Inch specifications

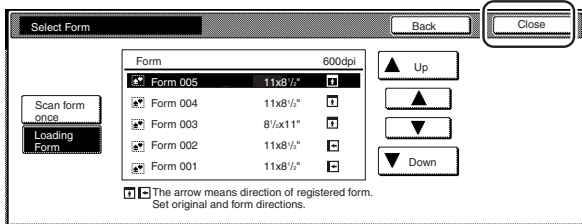

Metric specifications

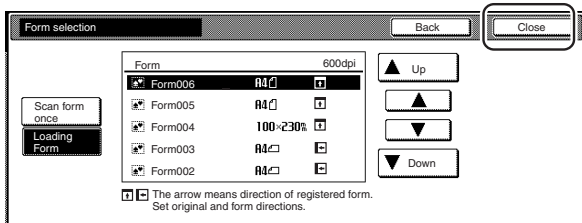

- 8** Set the originals that you want to copy and go directly to step 10.

- 9** If you are using the optional Document Processor, make sure that the original that you want to use as the form is on top of the originals that you want to copy.

If you are using the platen, set the original that you want to use as the form.

- 10** Press the [Start] key.
Copying will start.

If a message appears telling you to set the next original, go to the next step.

- 11** Replace the first original with the next one and press the [Start] key. Scanning of that next original will start.

- 12** Once you have finished scanning all of the originals, touch the “Scanning finished” key. Copying will start.

10. Making booklets from sheet originals [Booklet/Stitching mode]

With this mode, you can use 1-sided or 2-sided originals to make open-faced, two-sided copies in such a way that the finished copies can be stacked and folded into a booklet format. You can also select to have color paper or relatively thick paper fed as front and/or back covers to the copy sets.

NOTES

- Only 8 1/2" x 11", 11" x 8 1/2", 11" x 17", B5R, B5, A4R, A4, B4 and A3 size copy paper can be used in this mode.
- It is possible for you to change the drawer[cassette] that will be used to feed the cover sheets. (See "Cover drawer[cassette]" on page 7-71.)

Inch specifications

- If the optional Document Finisher with Center Bind & Fold Unit is installed on your copier, you will be able to select center binding (stapling) and folding. Only 8 1/2" x 11" and 11" x 17" size copy paper can be center folded and stapled.

Metric specifications

- If the optional Document Finisher with Center Bind & Fold Unit is installed on your copier, you will be able to select center binding (stapling) and folding. Only A4R, B4 and A3 size copy paper can be center folded and stapled.

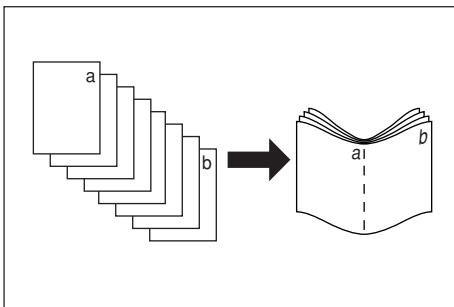

① If "Left" is selected as the binding direction...

Copying will be performed so that the stacked and folded pages of the finished copies read from left to right.

② If "Right" is selected as the binding direction...

Copying will be performed so that the stacked and folded pages of the finished copies read from right to left.

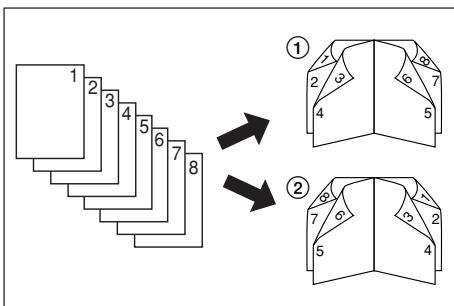

③ If "Top" is selected as the binding direction...

Copying will be performed so that the stacked and folded pages of the finished copies read from top to bottom.

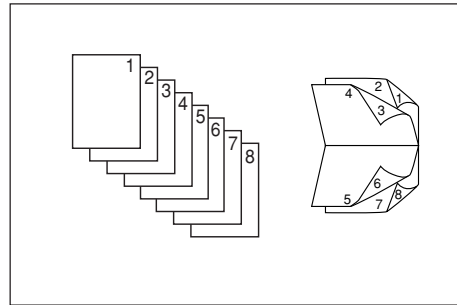

④ It is possible for you to select whether or not to copy onto the front and/or back cover sheets.

| | Front cover | Back cover |
|--------------------|-------------|------------|
| Do NOT copy | | |
| Copy on outside | | |
| Copy on inside | | |
| Copy on both sides | | |

NOTES

- The asterisk "★" indicates the side of the cover on which copying will be accomplished.
- The illustrations above are an example of when "Left" is selected as the binding direction.

- 1 Set the first original to be copied.
- 2 Touch the "Function" tab. The content of the "Function" tab will be displayed.
- 3 Touch the "Booklet" key. The "Booklet" screen will be displayed.

Inch specifications

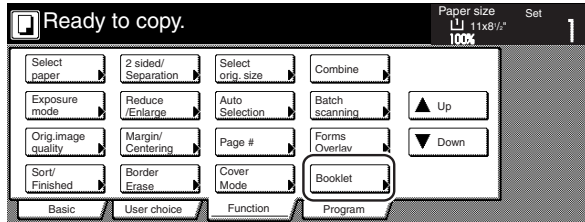

Metric specifications

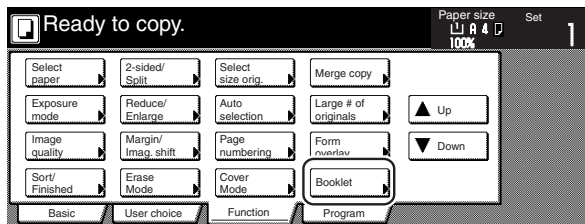

- 4 Touch the "Booklet" key. The screen to specify the binding direction of the originals and the finished copies will be displayed.

Inch specifications

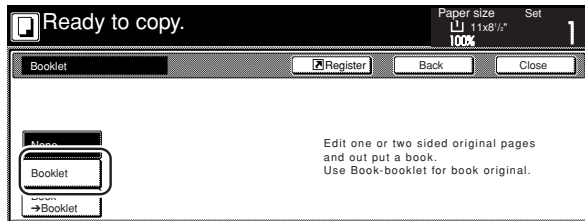

Metric specifications

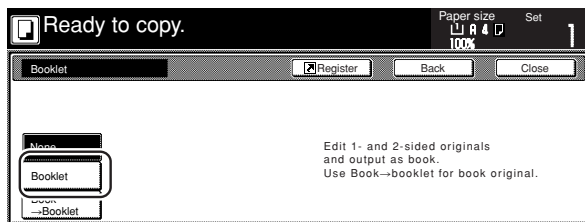

- 5 Specify the binding direction of both the originals and the finished copies.

Inch specifications

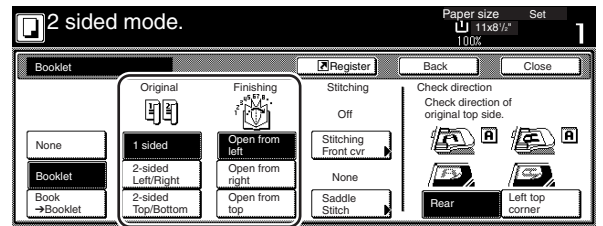

Metric specifications

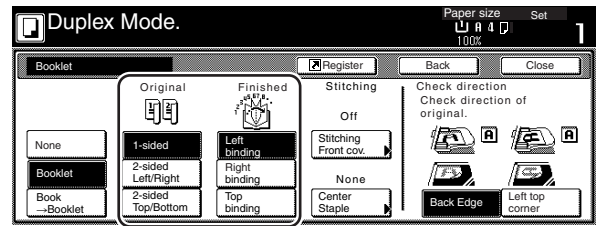

- 6 If "It is impossible to copy in present setting mode. Change setting of original and finishing mode." appears, check (on the right side of the touch panel) whether both the orientation of the originals and the finish mode setting are correct or not.

Inch specifications

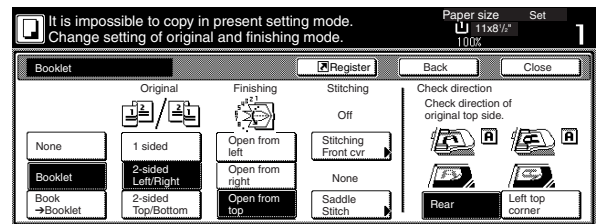

Metric specifications

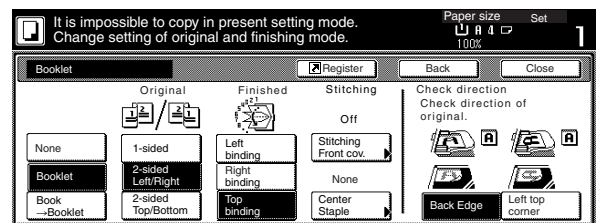

Section 5 OTHER CONVENIENT FUNCTIONS

- 7** If the optional Document Finisher with Center Bind & Fold Unit is installed on your copier, the “Saddle Stitch” [“Center Staple”] key will be displayed and you will be able to select center binding (stapling) and folding of the copy sets. In this case, if you DO want the center stapling and folding operation to be performed, touch the “Saddle Stitch” [“Center Staple”] key and go to the next step.

If you do NOT want the stapling and folding operation to be performed, go directly to step 9.

Inch specifications

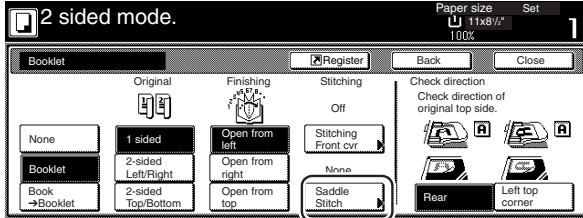

Metric specifications

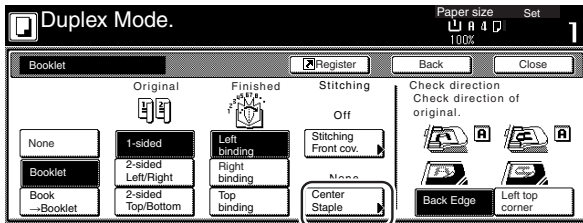

- 8** Touch the “Bind & Fold” key.
* It is possible for you to center staple and fold, up to 10 copy sheets (40 layout pages) at one time.

Inch specifications

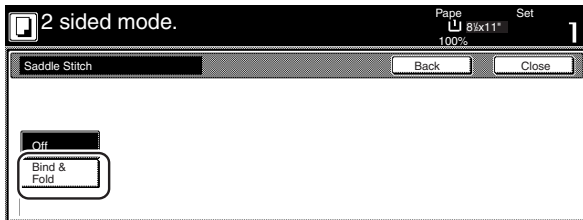

Metric specifications

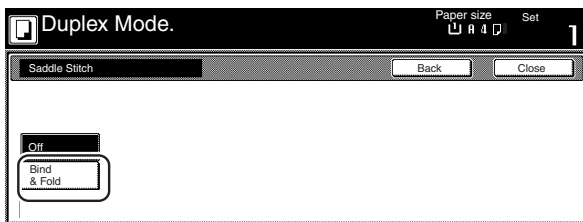

- 9** If you want to add covers, touch the “Stitching Front cvr” [“Stitching Front cov.”] key and go to the next step.
If you do NOT want to add covers, go directly to step 11.

Inch specifications

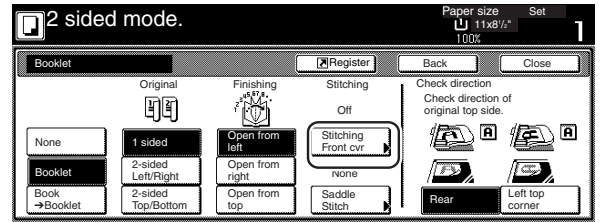

Metric specifications

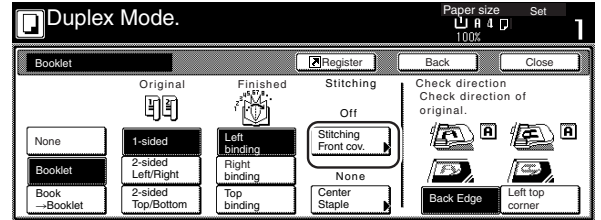

- 10** Touch the “Cover” key and select whether or not (and where) to copy on each of the front and back covers.

Inch specifications

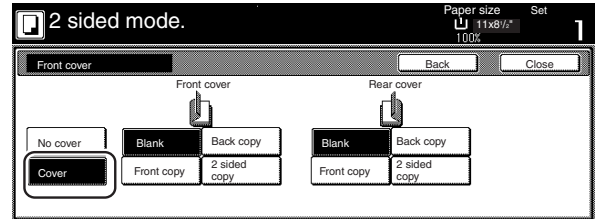

Metric specifications

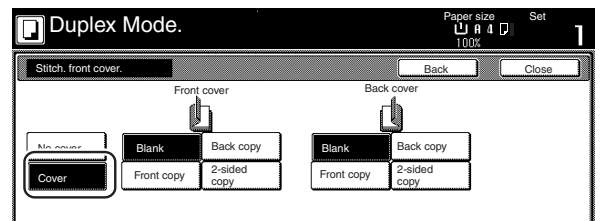

- 11** Press the [Start] key.
Scanning of the originals will start.

If you set the originals in the optional Document Processor, copying will start automatically.
If you set an original on the platen, a message will appear telling you to set the next original. In this case, go to the next step.

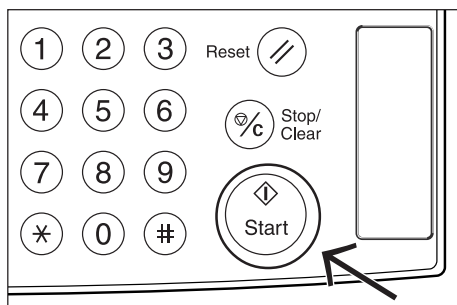

- 12** Replace the first original with the next one and press the [Start] key. Scanning of that next original will start.

- 13** Once you have finished scanning all of the originals, touch the "Scanning finished" key. Copying will start.

11. Making booklets from book originals [Book to Booklet mode]

With this mode, you can add covers, and either copy onto them or not, so that the finished copy sets will appear like a magazine, etc.

NOTES

- Only 8 1/2" x 11", 11" x 8 1/2", 11" x 17", A5R, B5R, A4R, B4 and A3 size originals and 8 1/2" x 11", 11" x 8 1/2", 11" x 17", B5R, B5, A4R, A4, B4 and A3 size copy paper can be used in this mode.
- It is possible for you to change the drawer[cassette] that will be used to feed the cover sheets. (See "Cover drawer[cassette]" on page 7-71.)

Inch specifications

- If the optional Document Finisher with Center Bind & Fold Unit is installed on your copier, you will be able to select center binding (stapling) and folding. Only 8 1/2" x 11" and 11" x 17" size copy paper can be center folded and stapled.

Metric specifications

- If the optional Document Finisher with Center Bind & Fold Unit is installed on your copier, you will be able to select center binding (stapling) and folding. Only A4R, B4 and A3 size copy paper can be center folded and stapled.

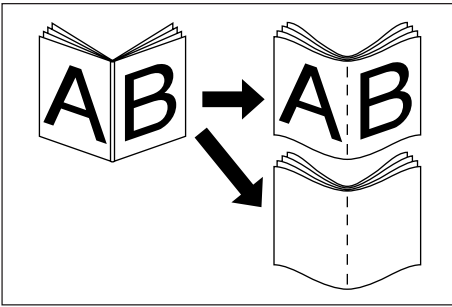

● With a cover

The original that will be used as the cover will be scanned first so that, when the finished copies are folded, that page will act as the front and back cover to the copy set.

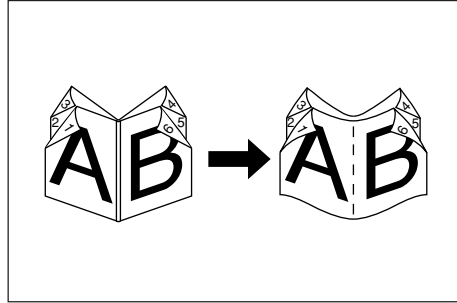

● Without a cover

When the finished copies are folded, the front and back of the copy set will be blank.

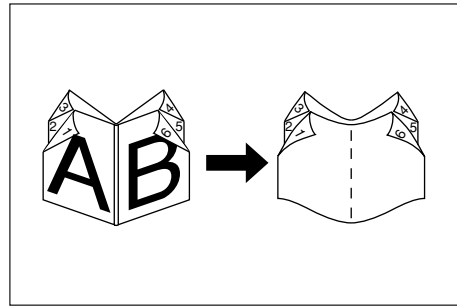

- 1 Set the open-faced (book, etc.) original to be copied.

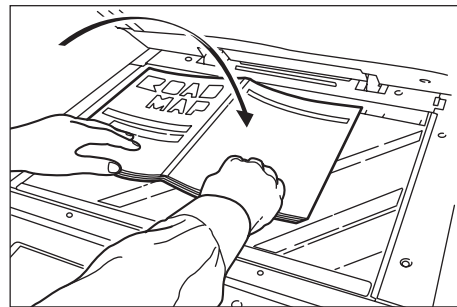

- 2 Touch the "Function" tab. The content of the "Function" tab will be displayed.

- 3** Touch the “Booklet” key. The “Booklet” screen will be displayed.

Inch specifications

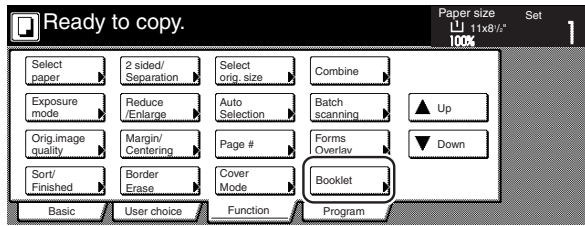

Metric specifications

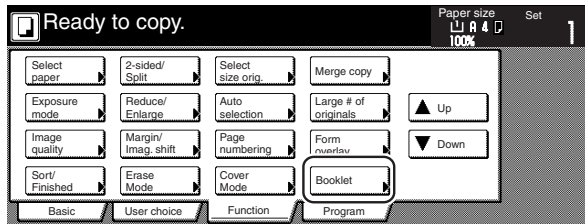

- 4** Touch the “Book → Booklet” key. The screen to specify the binding direction of the originals and the finished copies will be displayed.

Inch specifications

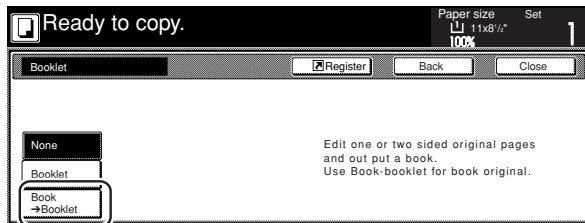

Metric specifications

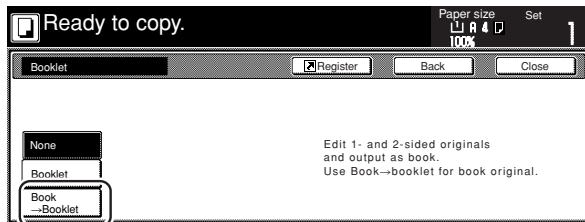

- 5** Specify the binding direction of both the originals and the finished copies.

Inch specifications

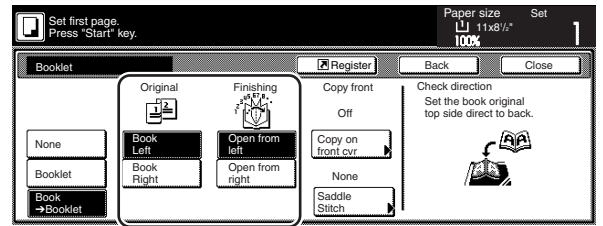

Metric specifications

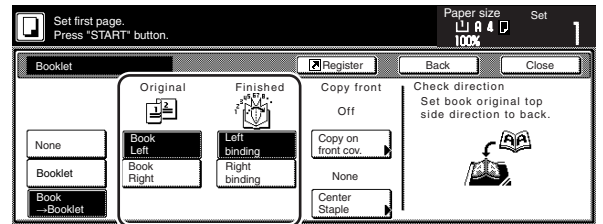

- 6** If the optional Document Finisher with Center Bind & Fold Unit is installed on your copier, the “Saddle Stitch” [“Center Staple”] key will be displayed and you will be able to select center binding (stapling) and folding of the copy sets. In this case, if you DO want the center stapling and folding operation to be performed, touch the “Saddle Stitch” [“Center Staple”] key and go to the next step.

If you do NOT want the stapling and folding operation to be performed, go directly to step 8.

Inch specifications

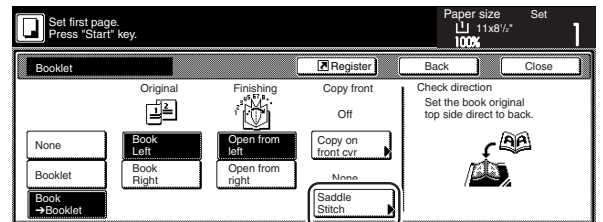

Metric specifications

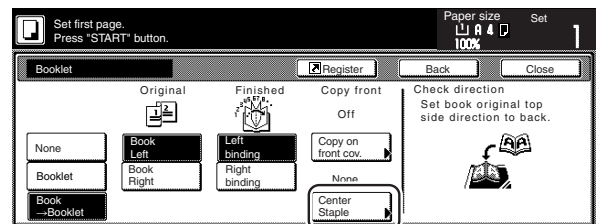

Section 5 OTHER CONVENIENT FUNCTIONS

7 Touch the "Bind & Fold" key.

* It is possible for you to center staple and fold, up to 10 copy sheets (40 layout pages) at one time.

Inch specifications

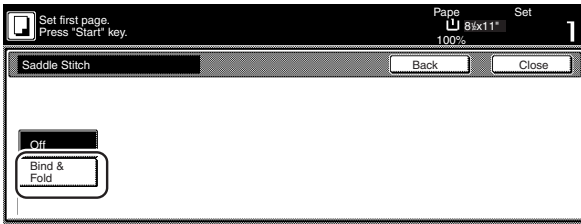

Metric specifications

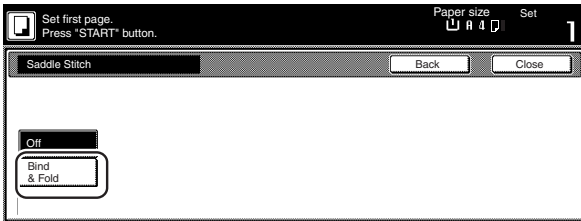

8 If you want to add covers, touch the "Copy on front cvr" ["Copy on front cov."] key. The "Copy on front cover" screen will be displayed.

At this point, if you do NOT want to copy onto the covers, go directly to step 10.

Inch specifications

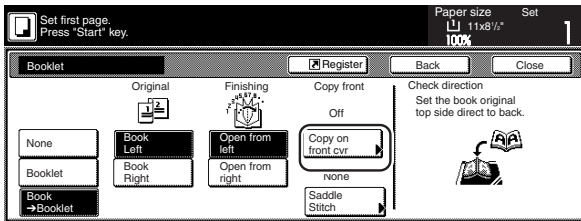

Metric specifications

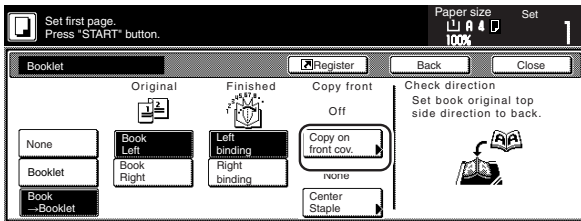

9 Touch the "On" key.

Inch specifications

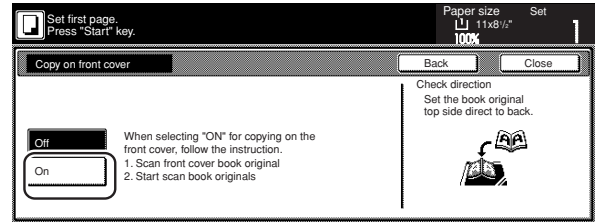

Metric specifications

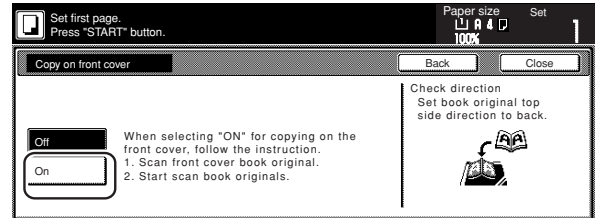

IMPORTANT!

If you DO want to copy onto the covers, be absolutely certain to set the original that you want to have copied onto the cover first.

10 Press the [Start] key. Scanning of the original will start.

When a message appears telling you to set the next original, go to the next step.

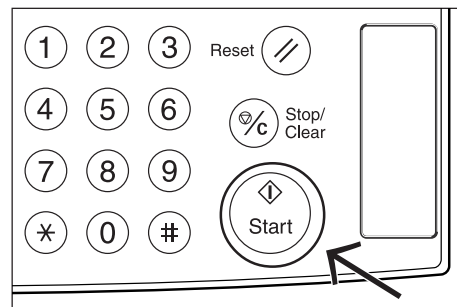

11 Replace the first original with the next one and press the [Start] key. Scanning of that next original will start.

12 Once you have finished scanning all of the originals, touch the "Scanning finished" key. Copying will start.

12. Automatic sorting of copy sets without the Document Finisher

[Sort/Finished mode]

Since copying in this mode is performed after multiple originals are scanned and memorized, copies can be sorted into the required number of sets even without the optional Document Finisher.

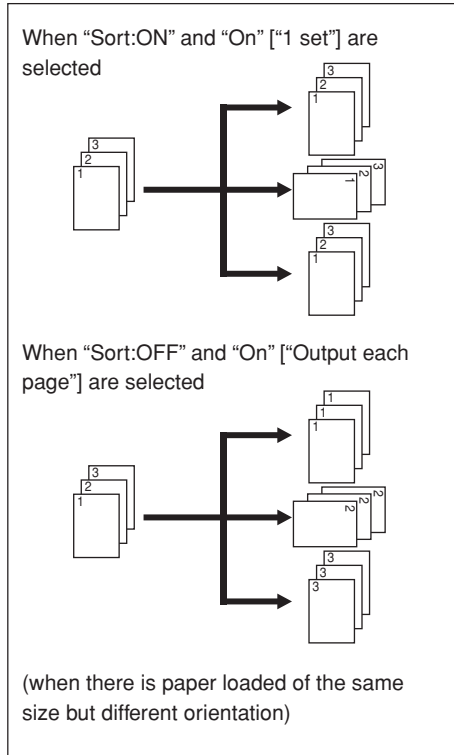

NOTES

- If you do not have paper of the same size but different orientations available for paper feed, copies will be ejected without being "sorted" in this way.
- You can also select whether or not the Sort and/or the Finished modes will be the default setting in the initial mode. (See "Sort/Finished mode ON/OFF" on page 7-78.)

1 Set the originals to be copied.

2 Touch the "Function" tab. The content of the "Function" tab will be displayed.

3 Touch the "Sort/Finished" key. The "Sort/Finished" screen will be displayed.

Inch specifications

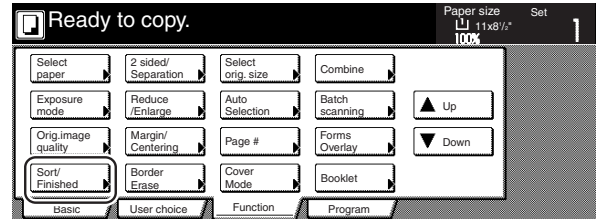

Metric specifications

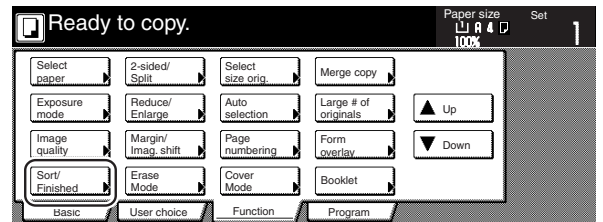

4 Touch the "Sort:ON" key.

Inch specifications

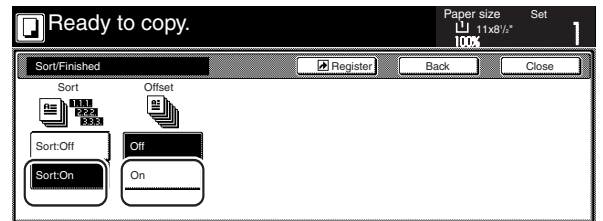

Metric specifications

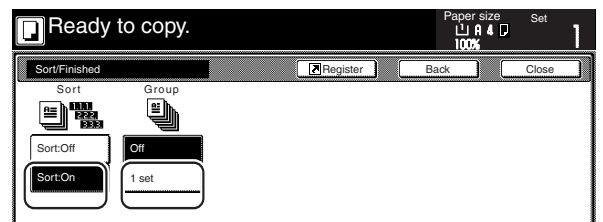

5 Touch the "On" ["1 set"] key.

6 Use the keypad to set the number of copies to be made.

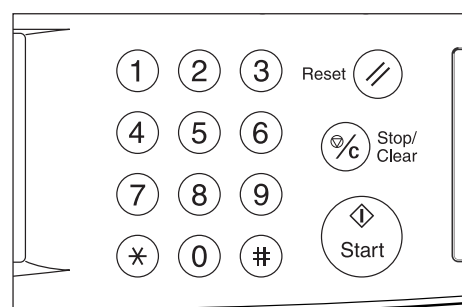

7 Press the [Start] key. Copying will start.

13. Auto rotation function

If the orientation of the original is different from that of the paper loaded in the drawers[cassettes], the image will be automatically turned 90 degrees counter-clockwise for copying. No special setting is required in order to use this function.

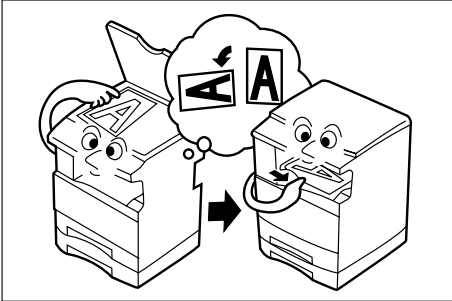

NOTES

- This function will only work with 5 1/2" x 8 1/2", 8 1/2" x 11", 11" x 8 1/2", A6R, B6R, A5R, B5R, B5, A4R and A4 size copy paper.
- You can also select whether or not the Auto Rotation mode will be the default setting in the initial mode. (See "Auto Rotation mode ON/OFF" on page 7-79.)

If you want to disengage the auto rotation function, perform the following procedure.

- 1 Touch the "Function" tab and then the "▼ Down" key. The content of the next portion of the "Function" tab will be displayed.

- 2 Touch the "Auto Rotation" key. The "Auto Rotation" screen will be displayed.

Inch specifications

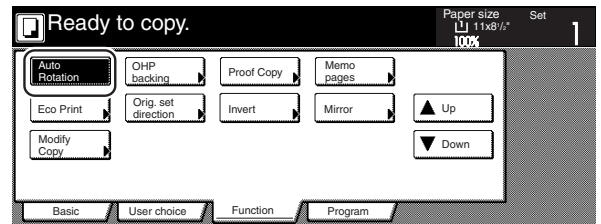

Metric specifications

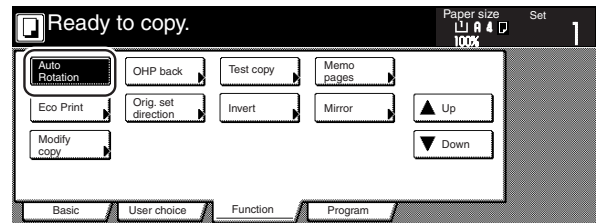

- 3 Touch the "No Rotate" key.

Inch specifications

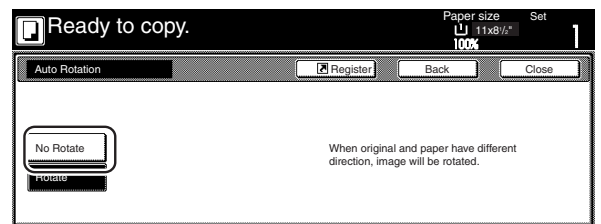

Metric specifications

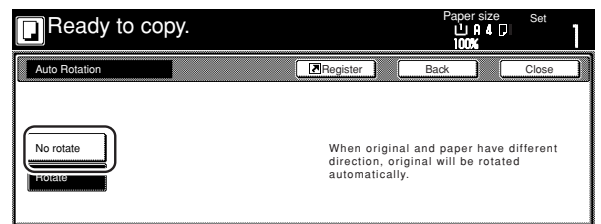

14. Adding a front and/or back cover to your copy sets [Cover mode]

With this mode, you can select to have color paper or relatively thick paper fed as front and/or back covers to your copy sets.

NOTE

It is possible for you to change the drawer[cassette] that will be used to feed the cover sheets. (See “Cover drawer[cassette]” on page 7-71.)

You can select separately whether you want both sides or only one side of both the front and back covers to be copied onto, or to have either or both of them left completely blank. Select also whether or not you even want to include a back cover at all.

| | Front cover | Back cover |
|----------------------------|-------------|------------|
| 2 sided copy[Duplex Copy]* | | |
| Front copy | | |
| Back copy* | | |
| Blank | | |
| No back cover | | |

* The illustrations above show the result when sets of 2-sided copies are being made.

If you are making sets of 1-sided copies, copying will not be performed on the rear side of the covers even if the 2-sided copy [Duplex Copy] or Back copy settings are selected.

Section 5 OTHER CONVENIENT FUNCTIONS

1 Set the originals to be copied.

2 Touch the “Function” tab. The content of the “Function” tab will be displayed.

3 Touch the “Cover Mode” key. The “Cover Mode” screen will be displayed.

Inch specifications

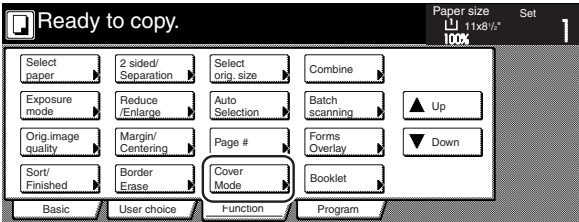

Metric specifications

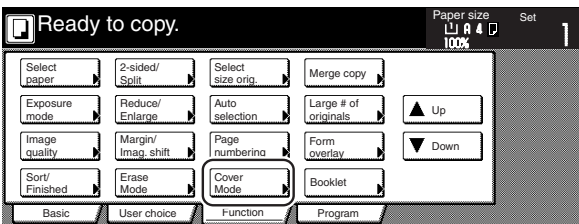

4 Touch the “Cover” key. The screen to make the front cover settings will be displayed.

Inch specifications

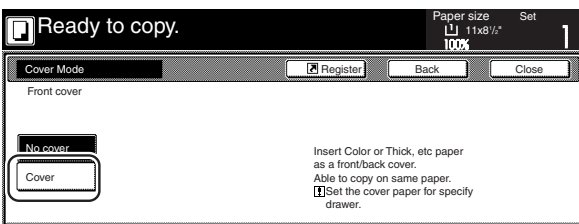

Metric specifications

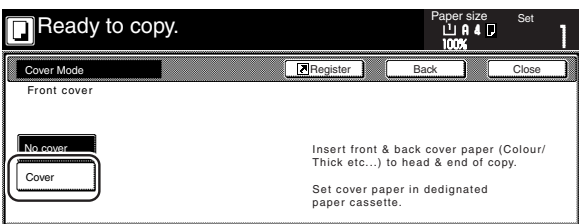

5 Select the desired settings for the front cover.

Inch specifications

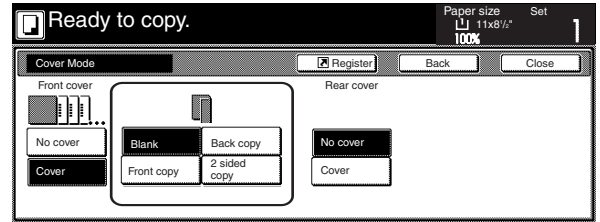

Metric specifications

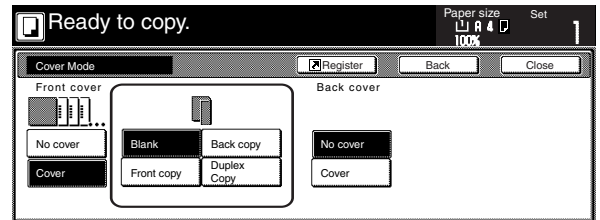

6 Touch the “Cover” key or the “No cover” key, as appropriate, to select whether or not you want to include a back cover. If you selected “Cover”, the screen to make the back cover settings will be displayed.

Inch specifications

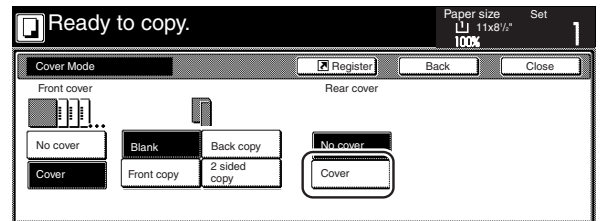

Metric specifications

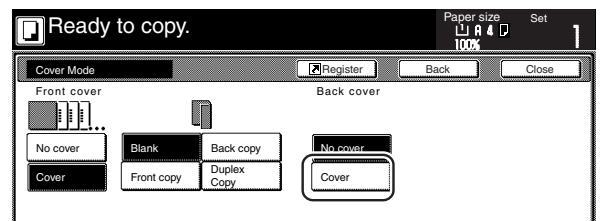

7 Select the desired settings for the back cover.

Inch specifications

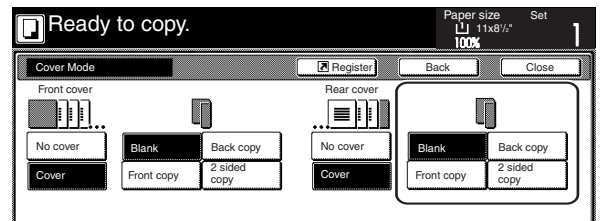

Metric specifications

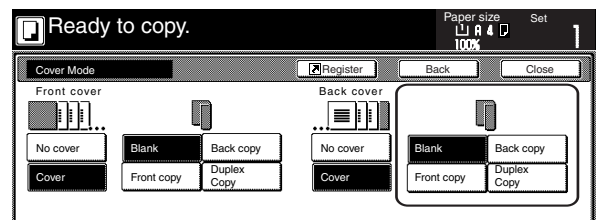

- 8** Press the [Start] key.
Scanning of the originals will start.

If you set the originals in the optional Document Processor, copying will start automatically.

If you set an original on the platen, a message will appear telling you to set the next original. In this case, go to the next step.

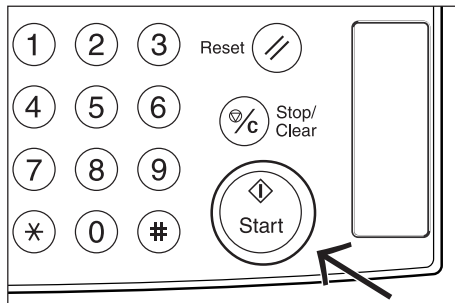

- 9** Replace the first original with the next one and press the [Start] key. Scanning of that next original will start.

- 10** Once you have finished scanning all of the originals, touch the "Scanning finished" key. Copying will start.

15. Original size selection mode

With this mode, if you manually select a size for the original, only that size image will be scanned for copying. Use this mode as well when copying from originals of non-standard sizes.

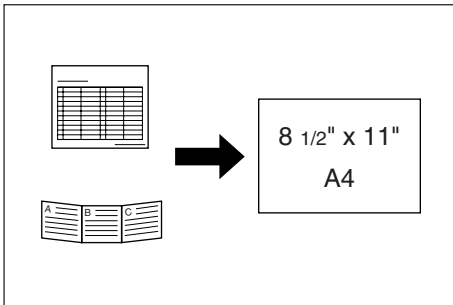

NOTES

- You can register the size of non-standard originals that you often use as a custom original size. (See “4. Original size registration” on page 7-90.)
- ALWAYS set non-standard sized originals on the platen.
- Once you select the original size under this mode, you can copy with originals set on the platen even with the optional Document Processor open.
- If this mode is used in combination with the Centering/Image shift mode, you can, for example, have the image of non-standard sized originals centered on standard sized copy paper. (See “4. Centering/Image shift mode” on page 5-8.)

1 Set the originals to be copied.

2 Touch the “Function” tab. The content of the “Function” tab will be displayed.

3 Touch the “Select orig. size” [“Select size orig.”] key. The “Select original size” [“Select size original”] screen will be displayed.

Inch specifications

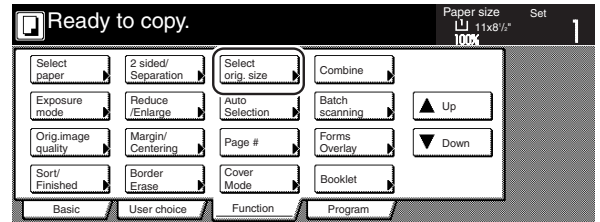

Metric specifications

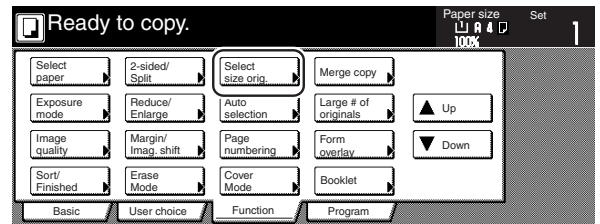

4 Select the size of the originals. If you want to select a standard scanning size, touch the key that corresponds to the desired size and then go directly to step 9.

If you want to select a standard size other than those displayed, go to the next step.

If you want to select the dimensions of the scan area manually, go directly to step 7.

Inch specifications

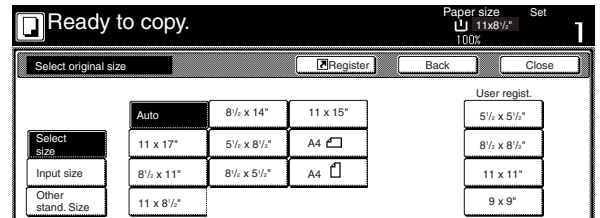

Metric specifications

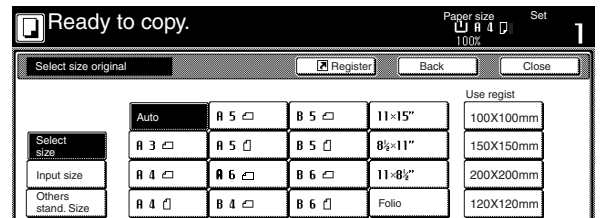

NOTE

If you have registered a custom original size, you will be able to select that size for use in this mode. (See “4. Original size registration” on page 7-90.)

5 Touch the “Other stand. Size” [“Others stand.Size”] key.

6 Select the size of the originals and then proceed to step 9.

Inch specifications

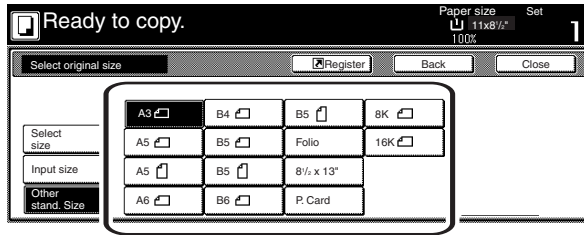

Metric specifications

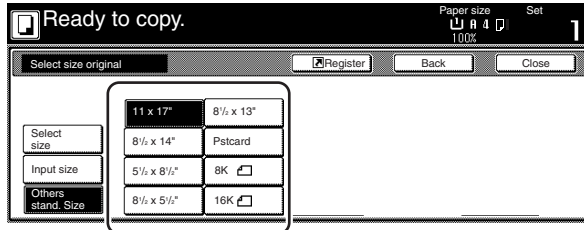

7 Touch the “Input size” key. The screen to set the dimensions of the scan area will be displayed.

8 Based on the left rear corner of the platen being a setting of “0”, touch the “+” key or the “-” key to change the dimensions of the scan area to the desired setting.

* In metric specification copiers, the dimensions can also be entered directly by touching the “#-Keys” key and then using the keypad.

Inch specifications

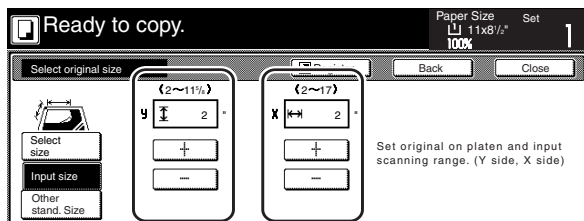

Metric specifications

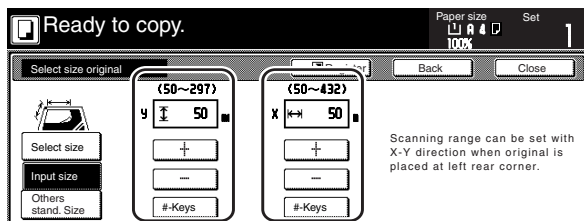

9 Press the [Start] key. Copying will start.

16. Feeding paper as a backing sheet for OHP transparencies

[Transparency + backing sheet mode]

When 2 or 3 transparencies are piled on top of one another, static electricity can cause problems. This mode automatically places a backing sheet between the transparencies during copying for easy handling. You can also select whether or not to have the image of the original copied onto the backing sheet, or even make multiple copies from the same original.

IMPORTANT!

When copying onto transparencies, ALWAYS use the multi-bypass tray.

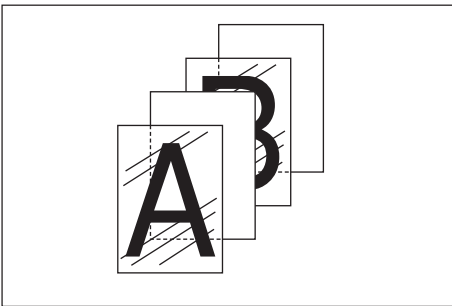

● Copying onto the backing sheet

With this setting, after the original is copied onto the transparency, the same image will be copied onto the backing sheet as well. (The asterisk "*" in the illustration indicates the transparencies.)

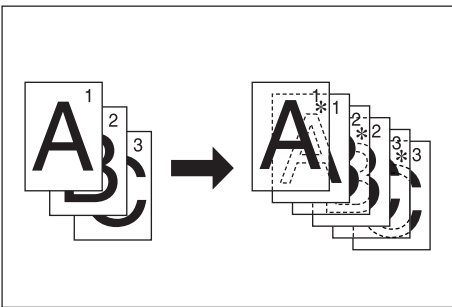

● Leaving the backing sheet blank

With this setting, the original will be copied onto the transparency but the backing sheet will be left blank. (The asterisk "*" in the illustration indicates the transparencies.)

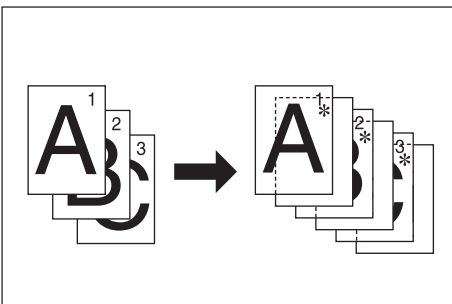

1 Set the originals to be copied.

2 Set the transparency film on the multi-bypass tray.

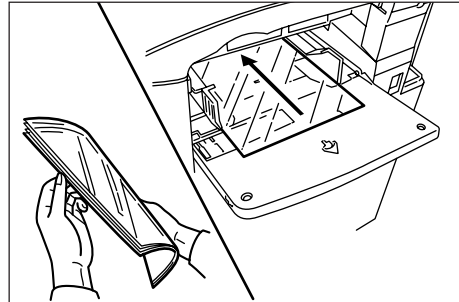

IMPORTANT!

- Fan through the transparencies before setting them.
- Up to 25 transparencies can be set on the multi-bypass tray at one time.
- Make sure that paper of the same size and orientation as the transparencies has been loaded into a drawer[cassette].

3 Touch the "Function" tab and then the "▼ Down" key. The content of the next portion of the "Function" tab will be displayed.

4 Touch the "OHP backing" ["OHP back"] key. The "OHP backing" ["OHP back"] screen will be displayed.

Inch specifications

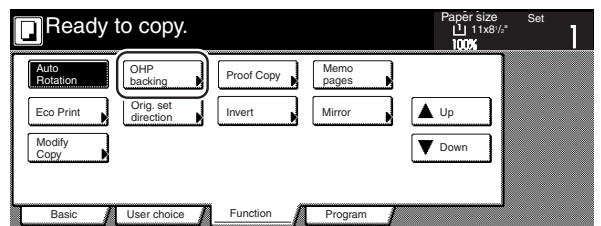

Metric specifications

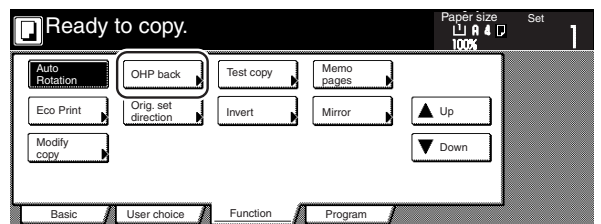

5 Touch the “Copy” key or the “Blank” key, as appropriate.

Inch specifications

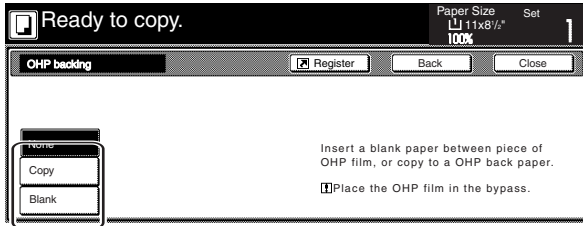

Metric specifications

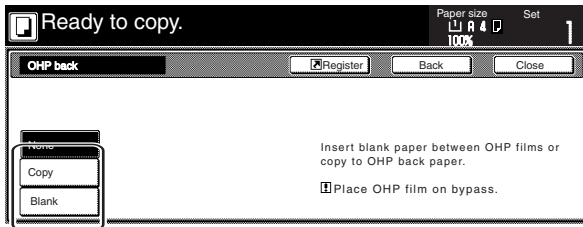

6 Press the [Start] key.
Copying will start.

17. Inverting black and white [Invert mode]

With this mode, you can make copies where the black and white areas of the image are inverted (or reversed).

* If multiple inverted copies are being made, "Please wait Now cleaning" may be displayed.

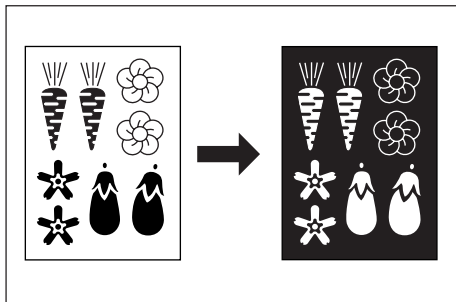

5 Touch the "On" key.

Inch specifications

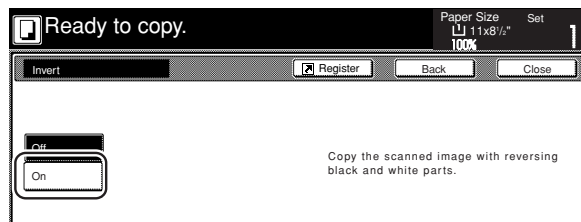

Metric specifications

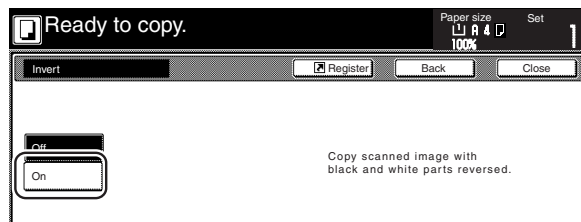

6 Press the [Start] key.

Copying will start.

1 Set the originals to be copied.

2 Touch the "Function" tab. The content of the "Function" tab will be displayed.

3 Touch the "▼ Down" key. The content of the next portion of the "Function" tab will be displayed.

4 Touch the "Invert" key. The "Invert" screen will be displayed.

Inch specifications

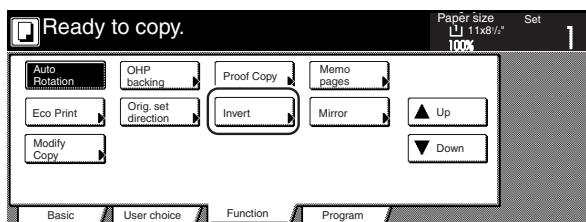

Metric specifications

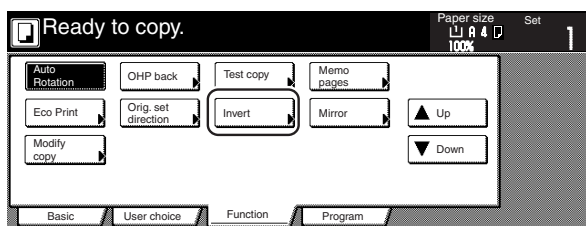

18. Making mirror image copies [Mirror image mode]

With this mode, you can make mirror image copies.

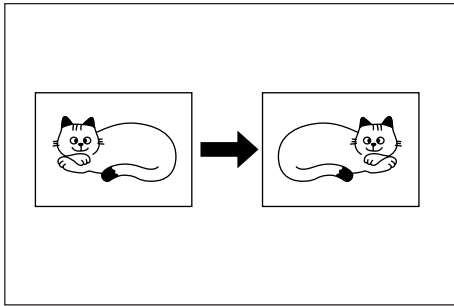

- 1** Set the originals to be copied.
- 2** Touch the “Function” tab. The content of the “Function” tab will be displayed.
- 3** Touch the “▼ Down” key. The content of the next portion of the “Function” tab will be displayed.
- 4** Touch the “Mirror” key. The “Mirror” screen will be displayed.

Inch specifications

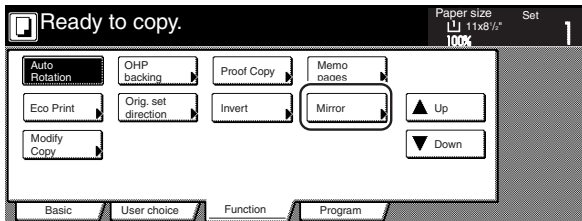

Metric specifications

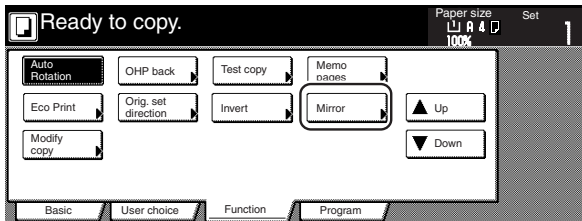

- 5** Touch the “On” key.

Inch specifications

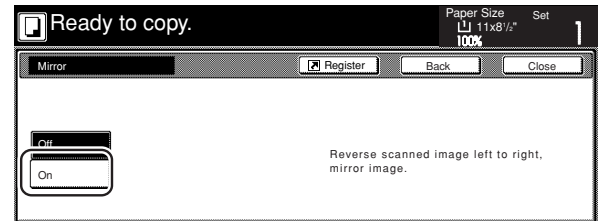

Metric specifications

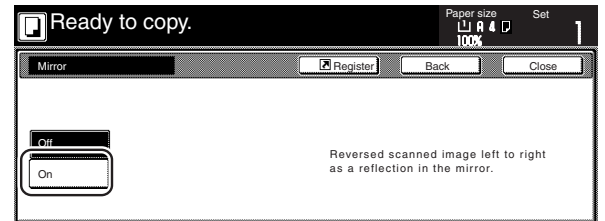

- 6** Press the [Start] key. Copying will start.

19. Making a test copy prior to large volume copying [Proof mode]

With this mode, you can use the same settings to create a single set of test copies in order to verify the results prior to actually starting to make a large number of copies or copy sets. This way, if there is a problem with the copies, you can cancel print out in order to change the settings and eliminate a great majority of miss-copying.

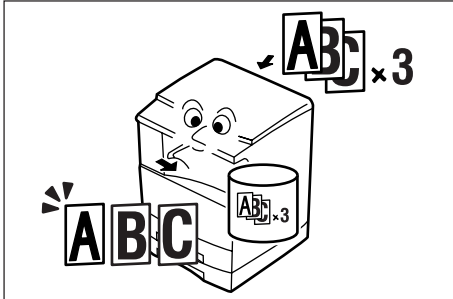

- 1** Set the originals to be copied.
- 2** Touch the “Function” tab. The content of the “Function” tab will be displayed.
- 3** Touch the “▼ Down” key. The content of the next portion of the “Function” tab will be displayed.
- 4** Touch the “Proof Copy” [“Test copy”] key. The “Proof Copy” [“Test copy”] screen will be displayed.

Inch specifications

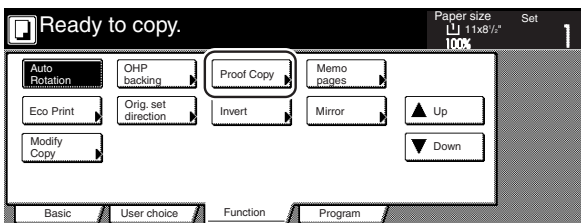

Metric specifications

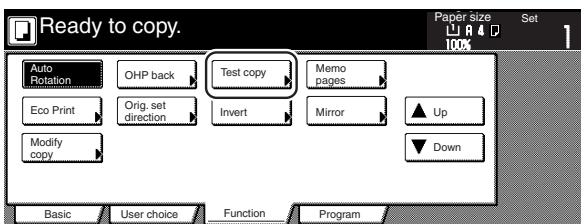

- 5** Touch the “On” key.
Inch specifications

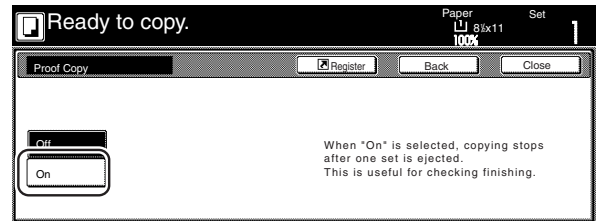

Metric specifications

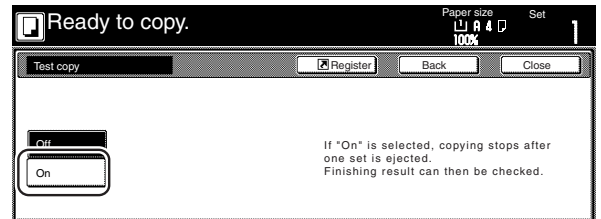

- 6** Press the [Start] key.
Copying will start.

If a message appears telling you to set the next original, go to the next step.

- 7** Replace the first original with the next one and press the [Start] key. Scanning of that next original will start.

- 8** Once you have finished scanning all of the originals, touch the “Scanning finished” key. Copying of the test copy set will start.

- 9** Once the test copy set is complete, a screen will be displayed in order to verify whether or not you want to make the initially designated number of copy sets at the present settings, and the copier will enter a waiting-to-copy state. Check the test copies.

Inch specifications

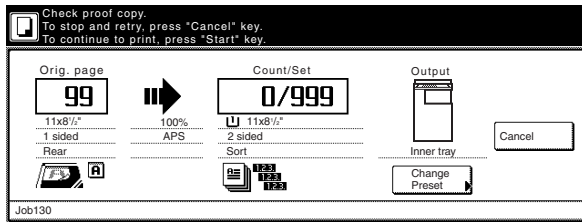

Metric specifications

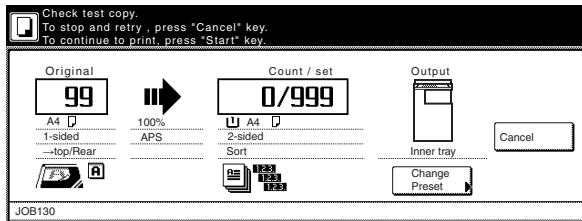

- If there is no problem with the copies...
Press the [Start] key and copying of the initially designated number of copy sets will start.
If you want to change the number of copies to be made, touch the "Change Preset" key and enter the actual number of copies you do want to make.
- If there is some problem with the copies...
Touch the "Cancel" key to cancel the copy job and start the procedure from the beginning.

20. Making more of the same copies after a copy job is finished

[Repeat copy mode]

With this mode, if you think you might want to make another set of the same copies even after the initial copy job is finished, simply turn the repeat copy mode ON and you can make the necessary number of additional copies later. In order to maintain privacy, you can make it necessary to enter a security code in order to use the repeat copy mode so that, if the entered code doesn't match the registered security code, it will not be possible to use the repeat copy mode.

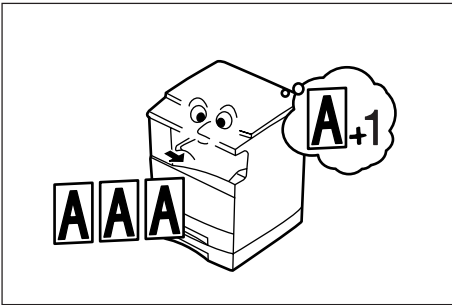

NOTES

- The optional Hard Disk must be installed on this copier in order to use this mode.
- All data for repeat copying will be deleted when the power switch is turned OFF.
- Repeat copying registration is not available for print out under document management or with the form overlay mode.
- You can prohibit repeat copying as well as make repeat copying the default setting in the initial mode. (See "Repeat copying ON/OFF" on page 7-83.)

(1) Registering a copy job for repeat copying

- 1 Set the originals to be copied.
- 2 Touch the "Function" tab. The content of the "Function" tab will be displayed.
- 3 Touch the "▼ Down" key. The content of the next portion of the "Function" tab will be displayed.

- 4 Touch the "Modify Copy" key. The "Modify Copy" screen will be displayed.

Inch specifications

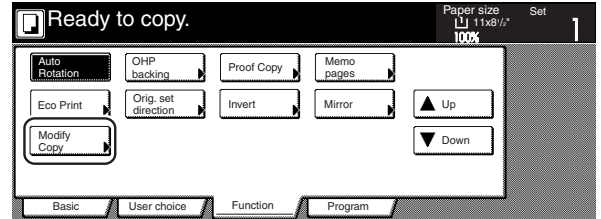

Metric specifications

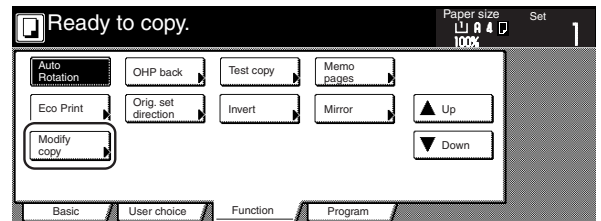

- 5 Touch the "On" key.

Inch specifications

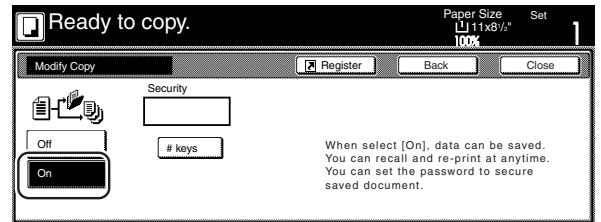

Metric specifications

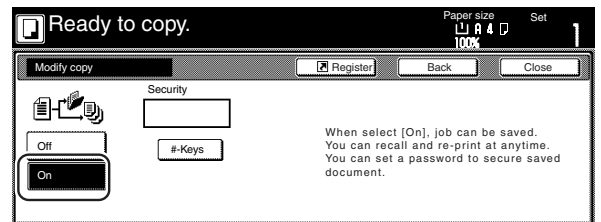

If you want to register a security code, go to the next step.

If you do NOT want to register a security code, go directly to step 7.

- Touch the "# keys" ["#-Keys"] key to highlight that key and then enter the security code that will enable repeat copying for these originals.

Inch specifications

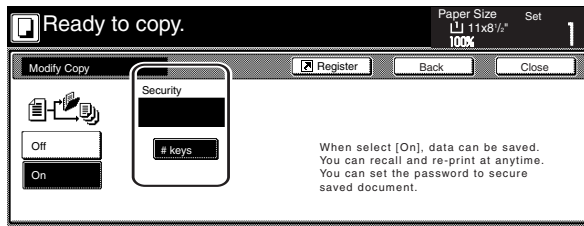

Metric specifications

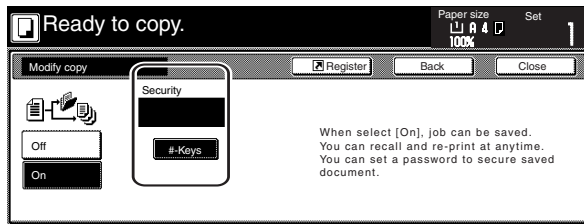

NOTES

- The security code can be between 1 and 8 digits long.
- If you forget the security code that you enter here, repeat copying will not be possible for these originals. Be sure to keep some sort of record of the security code.

- Press the [Start] key. Copying will start.

If a message appears telling you to set the next original, go to the next step.

- Replace the first original with the next one and press the [Start] key. Scanning of that next original will start.

- Once you have finished scanning all of the originals, touch the "Scanning finished" key. Copying will start.

(2) Printing out with the repeat copy mode

Once you press the [Repeat Copy] key, the "Modify copy" list will be displayed so that you can verify the copy jobs that are registered for repeat copying. It is possible to reprint, check the contents of, and delete the copy jobs that are registered in this list.

① Reprinting a registered copy job

- Press the [Repeat Copy] key. The "Modify copy" list will be displayed.

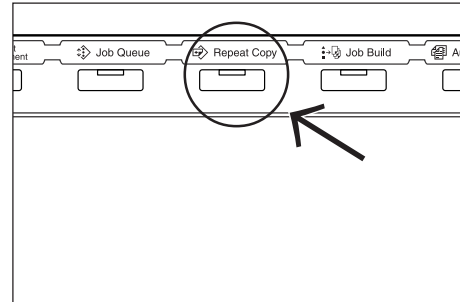

- Select the copy job that you want to reprint and touch the "Reprint" key.

Inch specifications

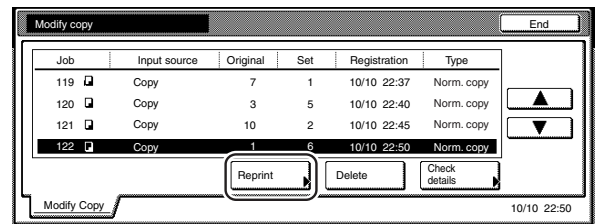

Metric specifications

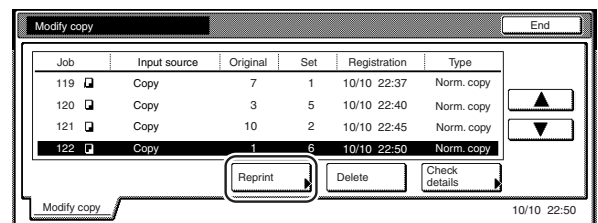

If you designated a security code when you registered the copy job for repeat copying, the code input screen will be displayed. In this case, go to the next step.

If you did NOT designate a security code when you registered the copy job for repeat copying, the screen to select the number of copies or copy sets to be made will be displayed. In this case, go directly to step 4.

Section 5 OTHER CONVENIENT FUNCTIONS

- Use the keypad to enter the appropriate security code and then touch the "Enter" key. If the entered code matches the registered one, the screen to select the number of copies or copy sets to be made will be displayed.

Inch specifications

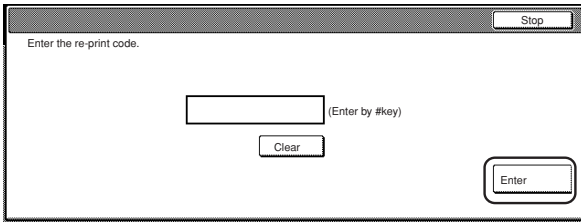

Metric specifications

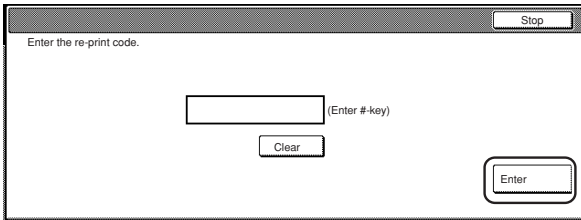

NOTES

- To reenter a mistaken security code, touch the "Clear" key.
- If you touch the "Stop" key, the touch panel will return to the screen in step 2.

- Touch the "+" key or the "-" key to set the number of copies or copy sets to be made.

Inch specifications

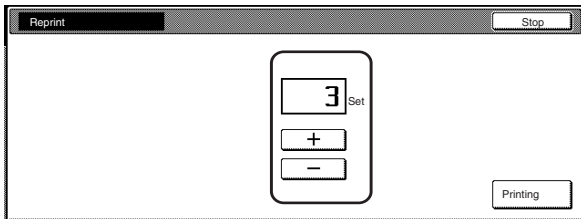

Metric specifications

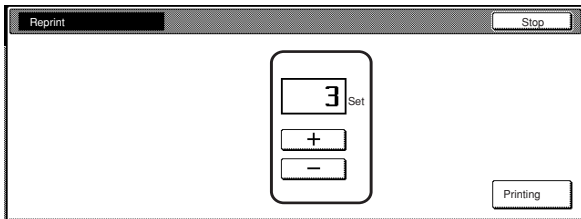

- Touch the "Printing" key. Print out will start.

② Checking the contents of registered copy jobs

- Press the [Repeat Copy] key. The "Modify copy" list will be displayed.

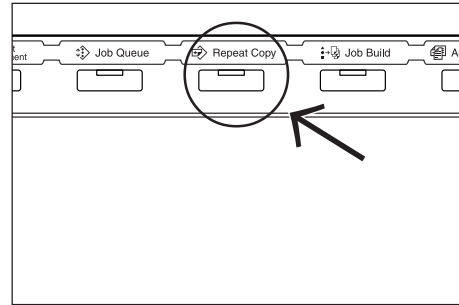

- Select the copy job that you want to check the content of and touch the "Check detail" key.

Inch specifications

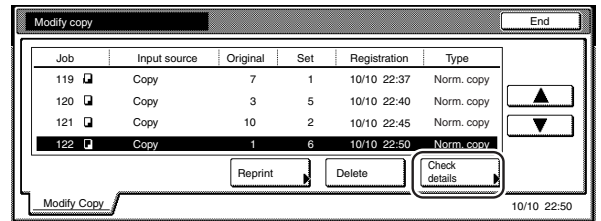

Metric specifications

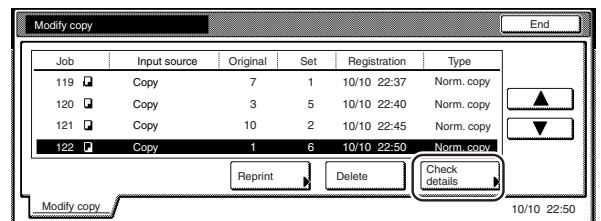

If you designated a security code when you registered the copy job for repeat copying, the code input screen will be displayed. In this case, go to the next step.

If you did NOT designate a security code when you registered the copy job for repeat copying, the "Check details / Reprint" screen will be displayed. In this case, go directly to step 4.

- Use the keypad to enter the appropriate security code and the touch the “Enter” key. If the entered code matches the registered one, the “Check details / Reprint” screen will be displayed.

Inch specifications

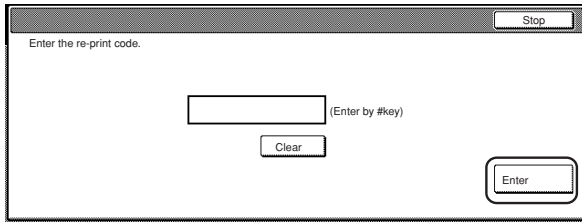

Metric specifications

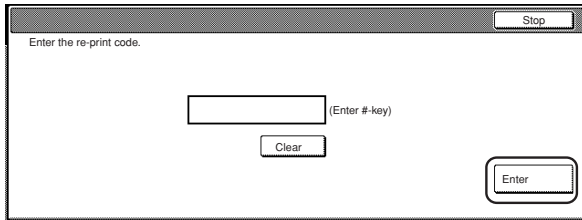

- Check the contents of the selected job. You can also check the content of the first page of the copy job by touching the “Print from 1st” [“Head print”] key.

Inch specifications

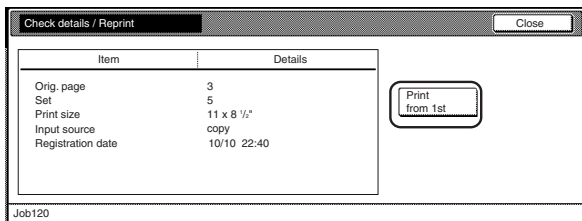

Metric specifications

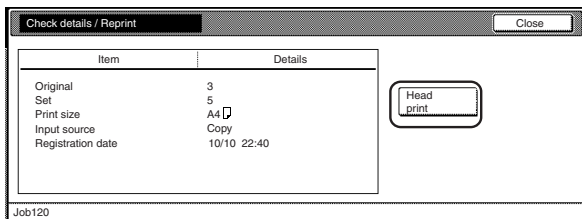

- Once you have finished checking the content of the copy job, touch the “Close” key. The touch panel will return to the screen in step 2.
- If you want to check the contents of another registered copy job, repeat steps 2 through 5.
- Touch the “Close” key. The touch panel will return to the contents of the “Basic” tab.

③ Deleting a registered copy jobs

- Press the [Repeat Copy] key. The “Modify copy” list will be displayed.

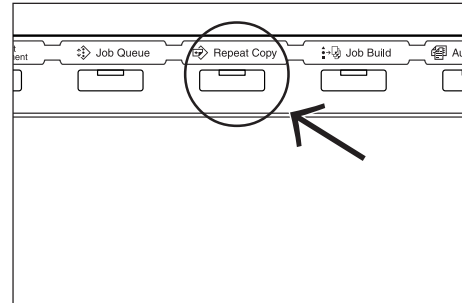

- Select the copy job that you want to delete and touch the “Delete” key. A verification screen will be displayed.

Inch specifications

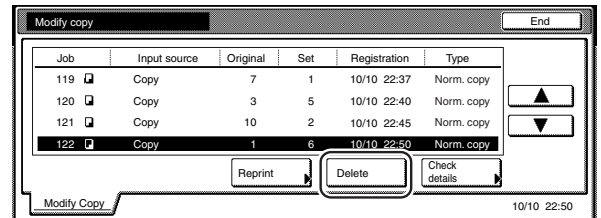

Metric specifications

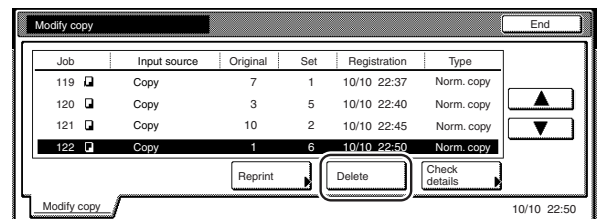

Section 5 OTHER CONVENIENT FUNCTIONS

3 Touch the “Yes” key or the “No” key, as appropriate.

Inch specifications

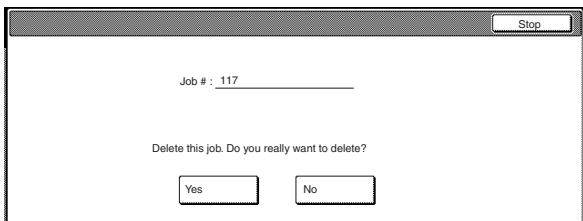

A screenshot of a touch panel dialog box. At the top right corner, there is a button labeled "Stop". The main content area displays "Job # : 117" followed by a horizontal line. Below this, the text "Delete this job. Do you really want to delete?" is centered. At the bottom, there are two buttons: "Yes" on the left and "No" on the right.

Metric specifications

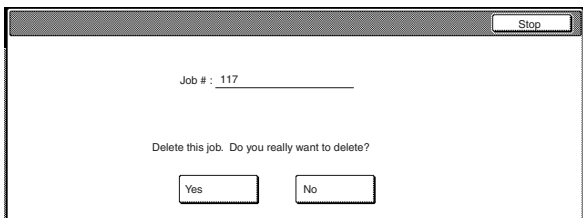

A screenshot of a touch panel dialog box, identical to the one above. It features a "Stop" button at the top right, the text "Job # : 117" with a horizontal line, the question "Delete this job. Do you really want to delete?", and "Yes" and "No" buttons at the bottom.

If you selected “Yes”, the selected copy job will be canceled and the touch panel will return to the screen in step 2.

If you selected “No”, the touch panel will return to the screen in step 2 without canceling the selected job.

4 If you want to cancel another registered copy job, repeat steps 2 through 3.

5 Touch the “Close” key. The touch panel will return to the contents of the “Basic” tab.

21. Copying a large volume of originals in one operation [Batch scanning mode]

With this mode, you can scan multiple sets of originals and then have them all copied at the same time. Scan one set of originals of the same type and then register that as a single step in the copy job, and you can copy an extremely large volume of originals in one batch.

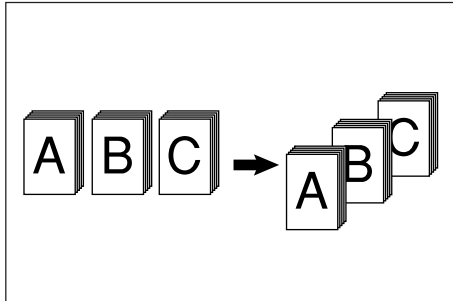

- 1** Set the originals to be copied.
- 2** Touch the "Function" tab. The content of the "Function" tab will be displayed.
- 3** Touch the "Batch scanning" ["Large # of originals"] key. The "Continuous scanning" ["Multiple scanning"] screen will be displayed.

Inch specifications

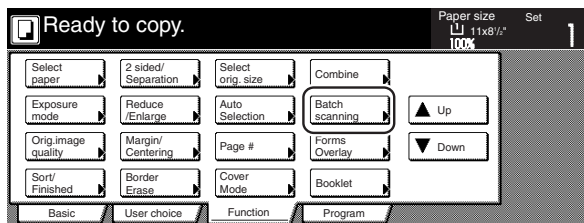

Metric specifications

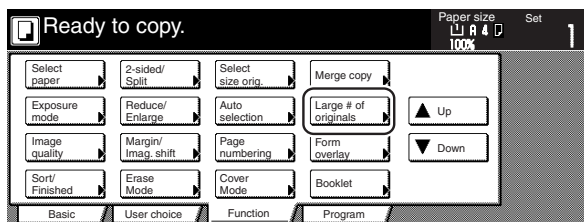

- 4** Touch the "On" key.

Inch specifications

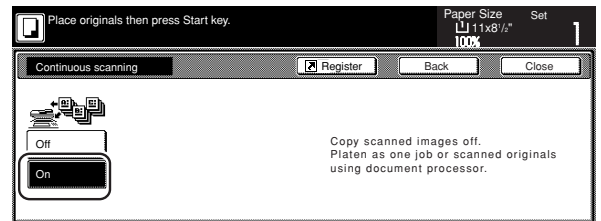

Metric specifications

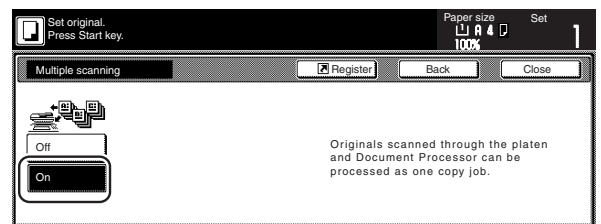

- 5** Press the [Start] key. Scanning of the originals will start.

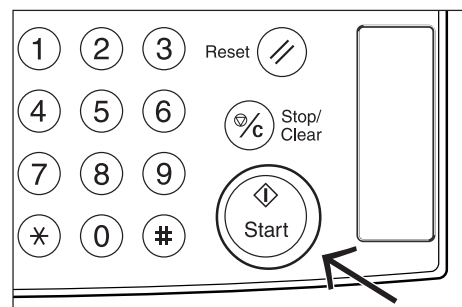

- 6** Replace the first originals with the next set and press the [Start] key. Scanning of those next originals (the next step in the copy job) will start.
- 7** Once you have finished scanning all of the originals, touch the "Scanning finished" key. Copying will start.

22. Saving on toner use [Eco print mode]

With this mode, you can reduce the amount of toner that is used to make the copies.

Use this mode with, for example making test copies, when you do not especially need to print out high quality copies. You can also make the eco print mode the default setting in the initial mode. (See “Eco print mode ON/OFF” on page 7-66.)

* Images will be printed out relatively lighter than normal.

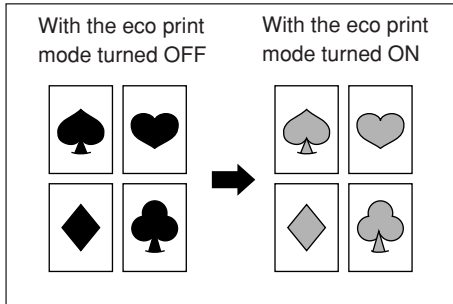

- 1** Set the originals to be copied.
- 2** Touch the “Function” tab. The content of the “Function” tab will be displayed.
- 3** Touch the “▼ Down” key. The content of the next portion of the “Function” tab will be displayed.

- 4** Touch the “Eco Print” key. The “Eco Print” screen will be displayed.

Inch specifications

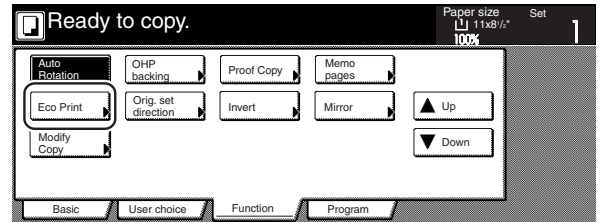

Metric specifications

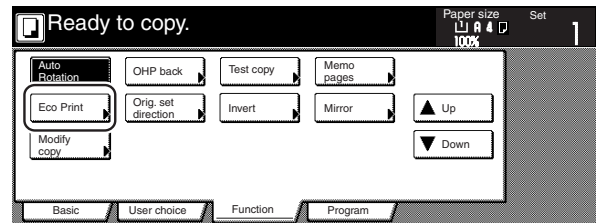

- 5** Touch the “Off” key or the “On” key, as appropriate.

Inch specifications

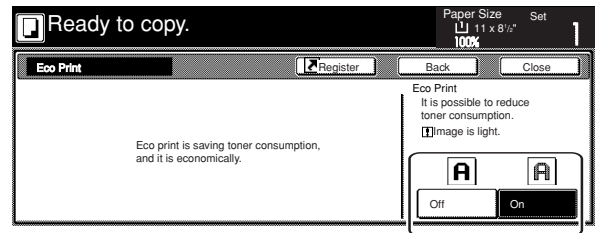

Metric specifications

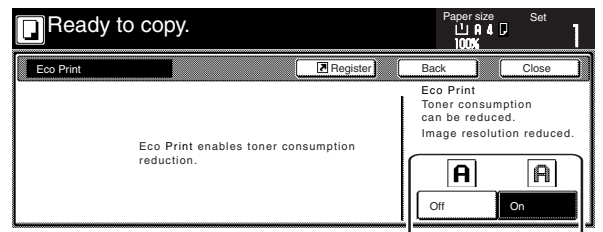

- 6** Press the [Start] key. Copying will start.

23. Original set direction

It is necessary to specify the direction in which the originals were set whenever you use the 2-sided copy modes, the page separation/split copy modes, the margin mode, the centering/image shift mode, the memo mode, the border erase modes, the combine/merge copy modes, the print page numbers mode, the booklet/stitching mode, the auto selection/filing mode (optional), the staple mode (optional) and the punch mode (optional). You can also use the following procedure to perform the setting as well.

- 1 Touch the "Function" tab. The content of the "Function" tab will be displayed.
- 2 Touch the "▼ Down" key. The content of the next portion of the "Function" tab will be displayed.
- 3 Touch the "Orig.set direction" key. The "Orig.set direction" screen will be displayed.

Inch specifications

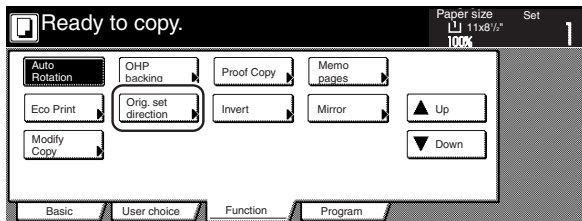

Metric specifications

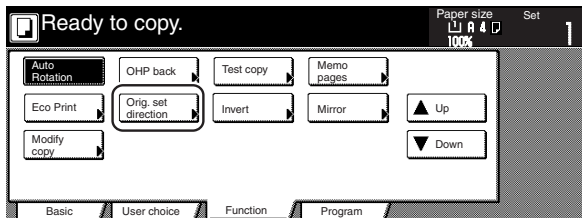

- 4 Touch the "Rear" ["Back Edge"] key or the "Left top corner" key, as appropriate.

Inch specifications

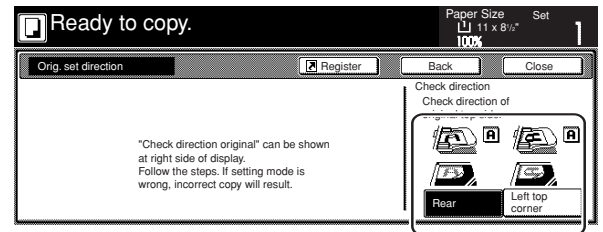

Metric specifications

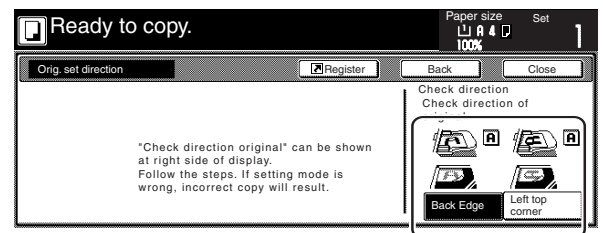

24. Memorizing frequently used settings [Program function]

Up to eight combinations of copy modes and other functions displayed on the operation panel can be registered as a single program using this function. You can also register a name for each registered program.

(1) Registering a program

- 1 Set the desired copy modes, etc., to be registered.
- 2 Touch the "Program" tab. The content of the "Program" tab will be displayed.
- 3 Touch the "Register" key.

Inch specifications

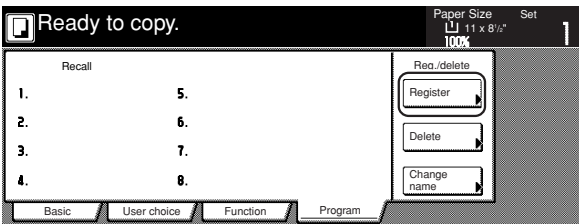

Metric specifications

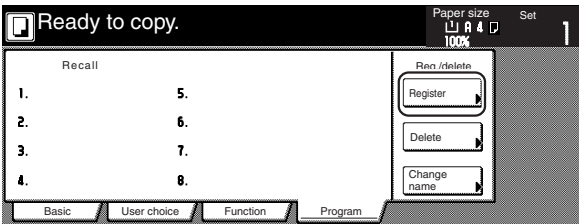

- 4 Touch any key that is marked "No registration" and that corresponds to the program key (1 – 8) under which you want to register the settings. The screen to register a name for that program will be displayed.

Inch specifications

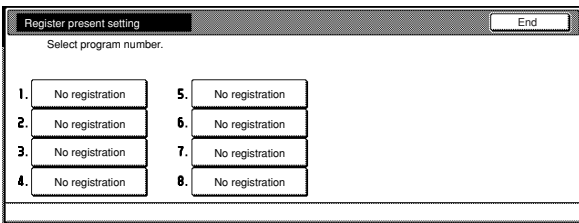

Metric specifications

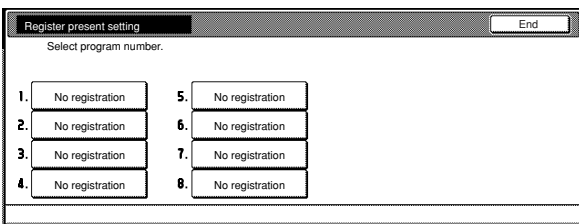

- 5 Use the displayed keyboard to enter the desired name and then touch the "End" key.

Inch specifications

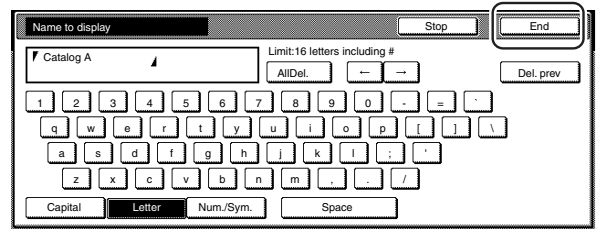

Metric specifications

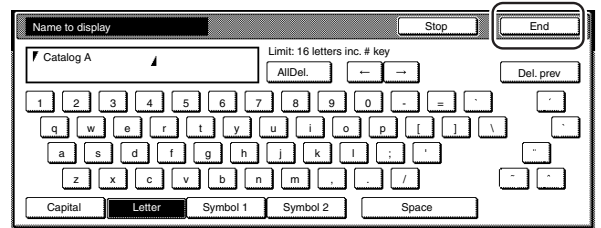

NOTE

Refer to "11. Entering characters" on page 7-104 for information on entering characters.

- 6 Touch the "Yes" key or the "No" key, as appropriate. If you selected "Yes", the selected program will be registered and the touch panel will return to the screen in step 3. Copying is now possible using the settings that were registered under that program.

Inch specifications

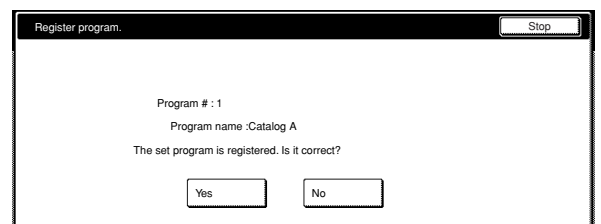

Metric specifications

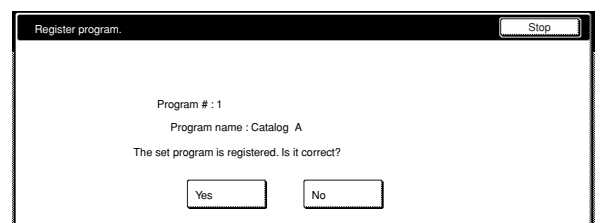

(2) Using programmed settings to make copies

- 1** Touch the “Program” tab. The content of the “Program” tab will be displayed.
- 2** Touch the program key under which the settings that you want to use are registered.

Inch specifications

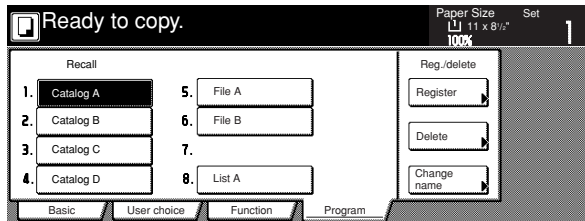

Metric specifications

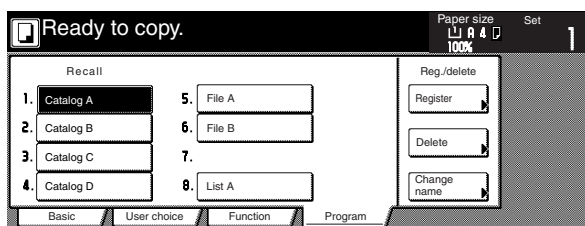

- 3** Set the originals to be copied and press the [Start] key. Copying will start using the settings that were registered under that program.

(3) Changing a registered program name

- 1** Touch the “Program” tab. The content of the “Program” tab will be displayed.
- 2** Touch the “Change name” key.

Inch specifications

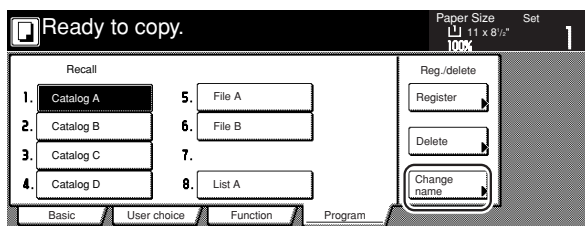

Metric specifications

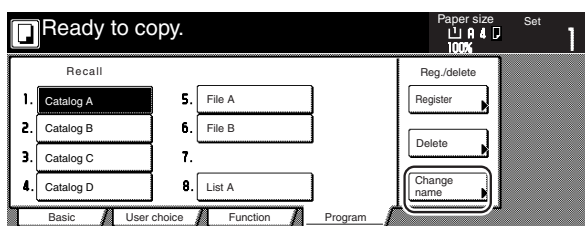

- 3** Touch the program key (1 – 8) for which you want to change the registered name. The screen to register a name for that program will be displayed.

Inch specifications

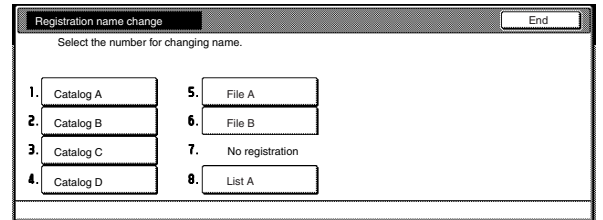

Metric specifications

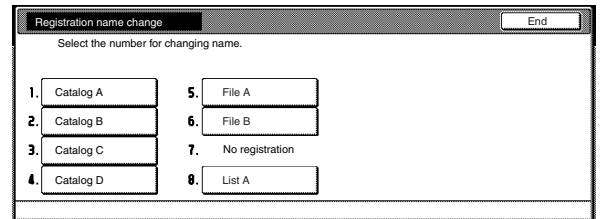

- 4** Once you have deleted the old name and entered the new one, press the “End” key.

Inch specifications

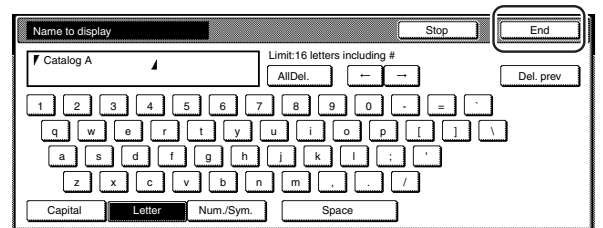

Metric specifications

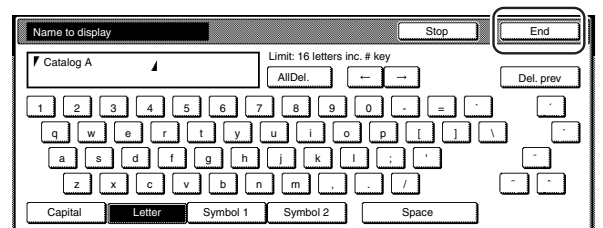

NOTE

Refer to “11. Entering characters” on page 7-104 for information on entering characters.

- 5** Once “The set program is registered. Is it correct?” is displayed, check the entered name and, if it is correct, touch the “Yes” key. The touch panel will return to the screen in step 2.

Section 5 OTHER CONVENIENT FUNCTIONS

(4) Deleting a registered program

1 Touch the “Program” tab. The content of the “Program” tab will be displayed.

2 Touch the “Delete” key.

Inch specifications

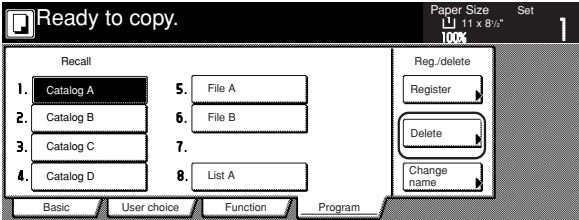

Metric specifications

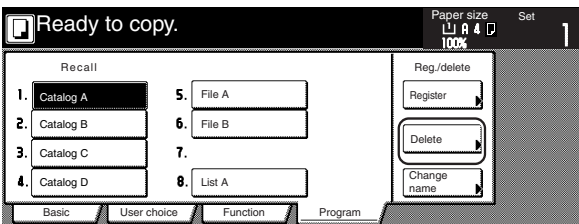

3 Touch the program key (1 – 8) that corresponds to the program that you want to delete.

Inch specifications

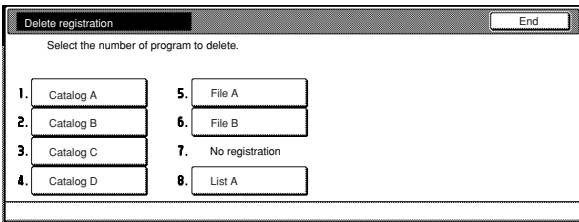

Metric specifications

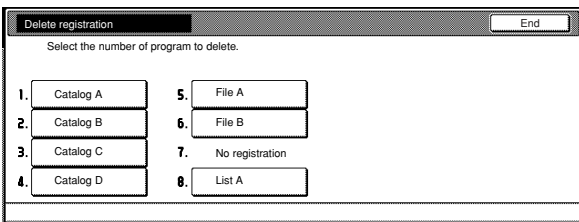

4 Touch the “Yes” key or the “No” key, as appropriate.

Inch specifications

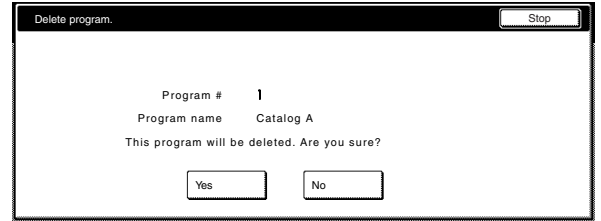

Metric specifications

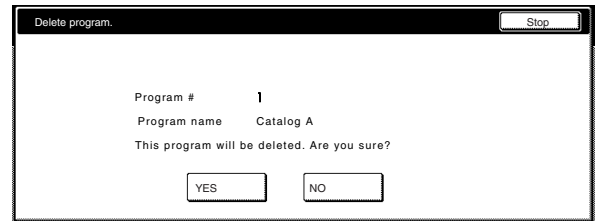

If you selected “Yes”, the selected program will be deleted and the touch panel will return to the screen in step 2.

If you selected “No”, the touch panel will return to the screen in step 3 without deleting the selected program.

25. Registration keys

You can register up to 3 functions and/or modes, from among those displayed in the “Function” tab, under the registration keys. The functions and modes in the “Basic” tab and the “User choice” tab can be registered under registration keys as well.

(1) Registering a function or mode under a function key

Perform the following procedure when you want to register a function or mode under a registration key.

To register a function or mode under a registration key, refer to the following sample procedure (which shows how to register the “4 in 1” combine/merge copy mode under a registration key).

IMPORTANT!

In order to register functions and/or modes under registration keys, you must first turn the setting ON under “Registration keys ON/OFF” on page 7-84.

1 Touch the “Function” tab. The content of the “Function” tab will be displayed.

2 Touch the “Combine” [“Merge copy”] key. The “Combine” [“Merge copy”] screen will be displayed.

Inch specifications

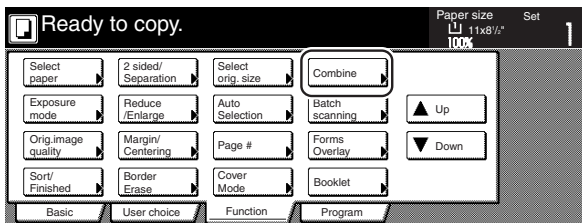

Metric specifications

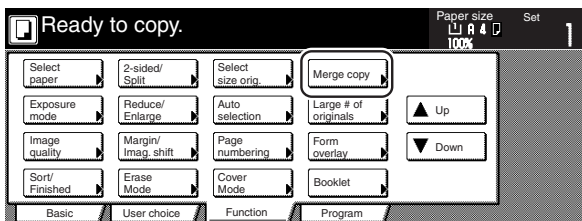

3 Touch the “4 in 1” key and then the “Register” key.

Inch specifications

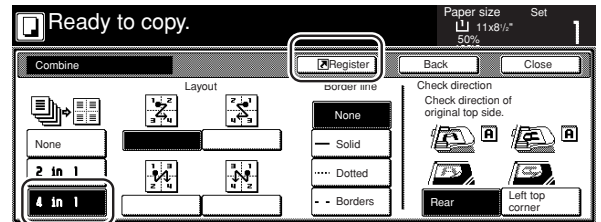

Metric specifications

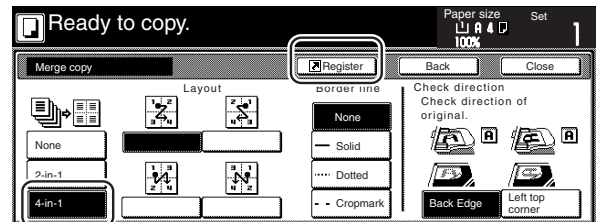

4 In the “Register” screen, touch the “Register” key once again. The screen to register functions and/or modes under registration keys will be displayed.

Inch specifications

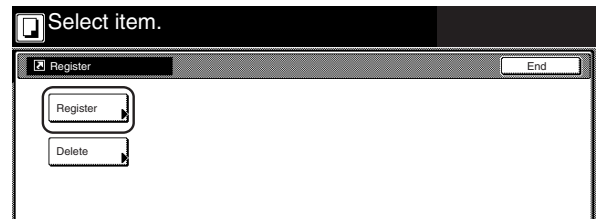

Metric specifications

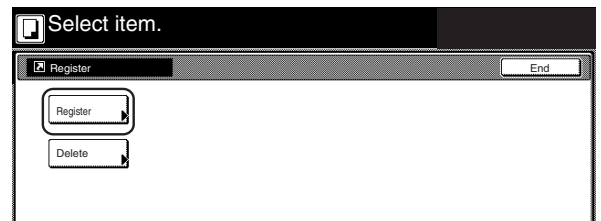

Section 5 OTHER CONVENIENT FUNCTIONS

- 5** Touch the registration key under which you want to register the function. "Register this selecting mode. OK?" will be displayed.

Inch specifications

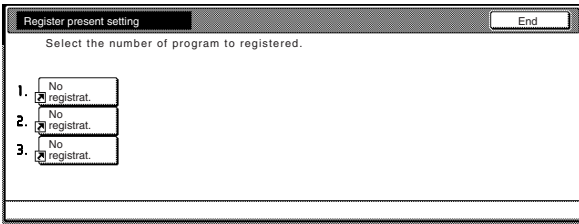

Metric specifications

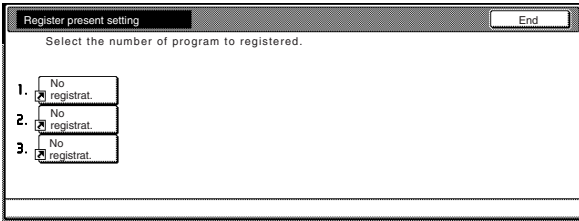

- 6** Touch the "Yes" key. The "Combine" ["Merge copy"] screen will be displayed again.

Inch specifications

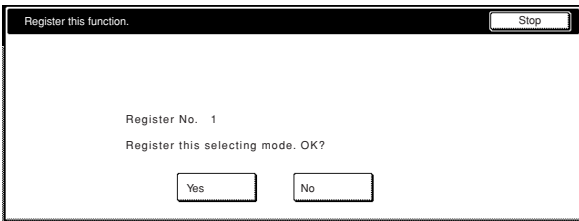

Metric specifications

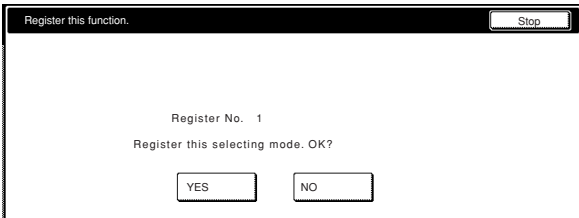

NOTE

If, in the screen to register functions and/or modes under registration keys, you select a previously registered key, the following screen will be displayed.

Inch specifications

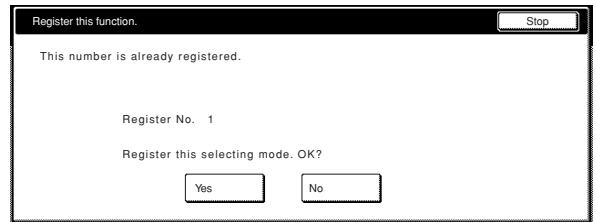

Metric specifications

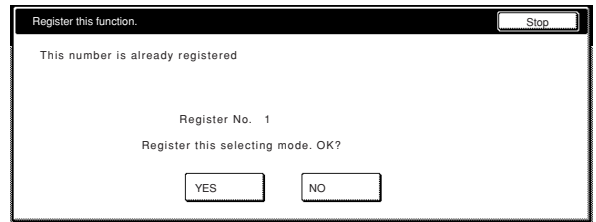

If you selected "Yes", the selected function will be registered under the registration key.

If you selected "No", the touch panel will return to the screen in step 5 without registering the selected function.

- 7** Touch the "Close" key. The "Combine" ["Merge copy"] key will now appear on the right side of the touch panel as a registration key.

Inch specifications

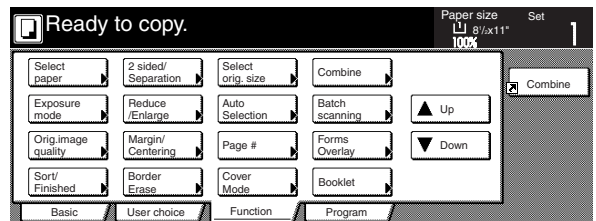

Metric specifications

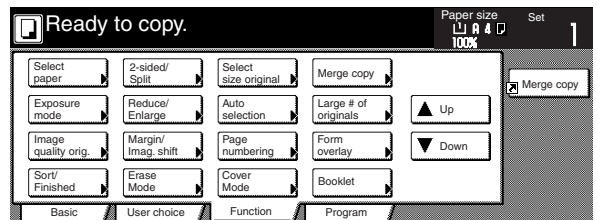

NOTE

The functions and modes in the "Basic" tab and the "User choice" tab can be registered under registration keys as well. A "Register" key will be displayed in the screen for those function and modes which can be registered under the registration keys.

(2) Deleting a registration key

Perform the following procedure when you want to delete a registration key.

- 1 Touch the registration (to the right of the “Basic” tab) that you want to delete. (Example: “Combine” [“Merge copy”])

Inch specifications

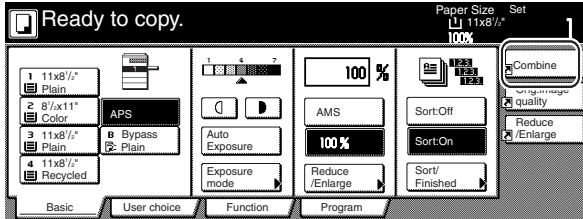

Metric specifications

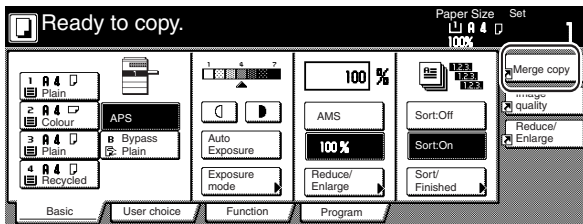

- 2 In the resulting screen for that function or mode (example: the “Combine” [“Merge copy”] screen), touch the “Register” key. The “Register” screen will be displayed.

Inch specifications

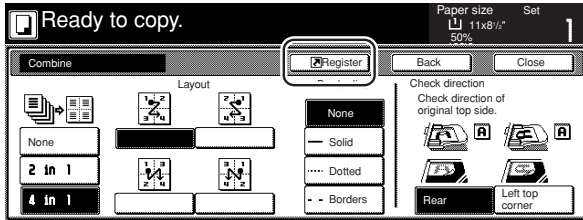

Metric specifications

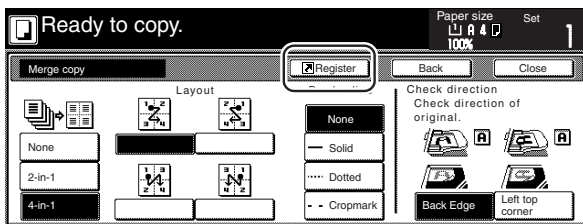

- 3 In the “Register” screen, touch the “Delete” key once again. The screen to delete registration keys will be displayed.

Inch specifications

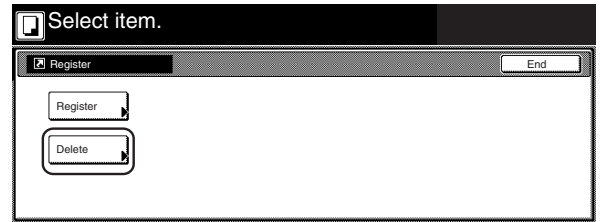

Metric specifications

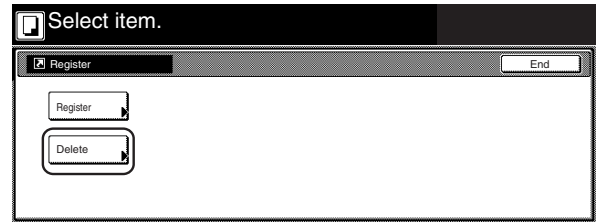

- 4 Touch the registration key (1 – 3) that corresponds to the program that you want to delete. “Are you sure you want to delete?” will be displayed.

Inch specifications

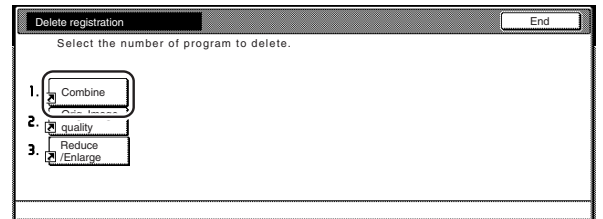

Metric specifications

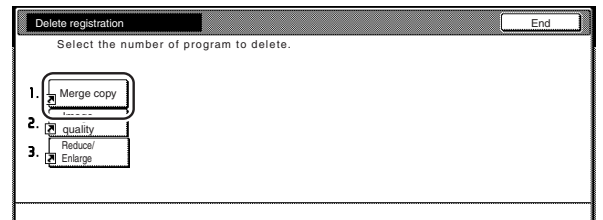

Section 5 OTHER CONVENIENT FUNCTIONS

- 5** Touch the “Yes” key. The “Combine” [“Merge copy”] screen will be displayed again.

Inch specifications

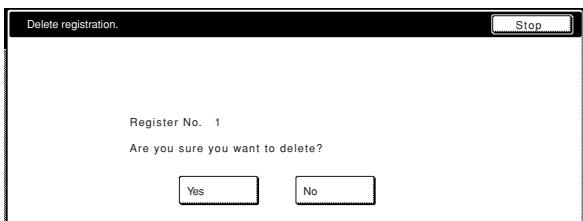

Metric specifications

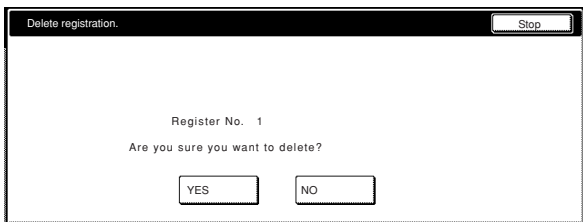

- 6** Touch the “Close” key. The “Combine” [“Merge copy”] key will be deleted from on the right side of the touch panel.

Inch specifications

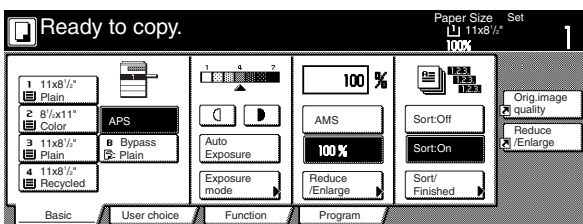

Metric specifications

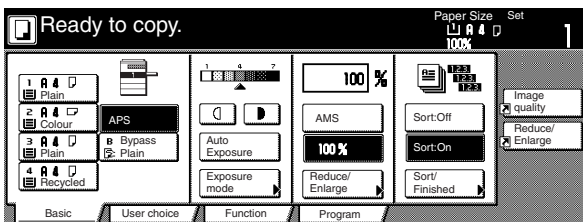

26. Easily add covers and insert sheets between various sets of originals in one operation [Job build mode]

The job build function enables you to scan different sets of originals into memory in separate steps and then copy them all at one time. Each set of scanned originals is then seen as one step in the copy process and you can select different copy modes for each step (enlarge/reduce, border erase, original type [2-sided originals, 1-sided originals or open-faced book originals]). You can choose to have a blank sheet of paper fed in between each set of originals, as well as have front and rear covers included for the full set, AND do this all during 2-sided copying!

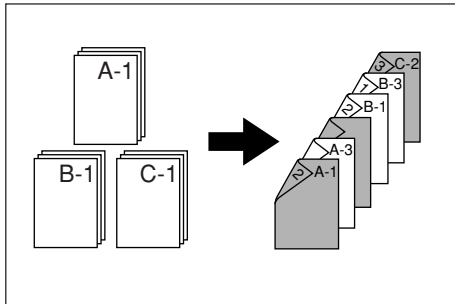

(1) Using the job build mode

The following procedure shows one way of using the job build mode and explains how to perform that operation under the situation indicated in the examples below.

[Example]

<Finished copies>

(The asterisk "*" in the illustration indicates the blank sheets.)

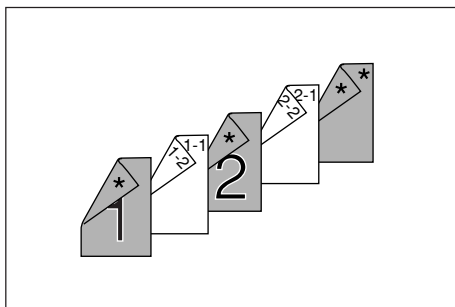

<Originals>

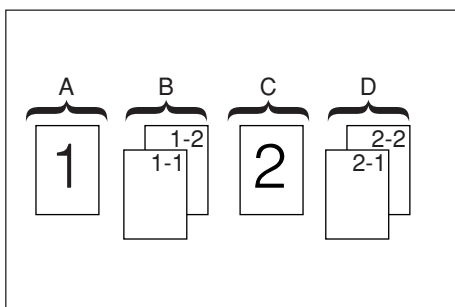

NOTE

This procedure will assume that the color paper to be used as the front cover and the middle insert (originals "A" and "C"), as well as for the back cover, will be set on the multi-bypass, and that there is plain copy paper loaded in drawer[cassette] No.1.

● Step 1: Accessing the "Job build" screen

- 1 Press the [Job build] key.
The "Job build" screen will be displayed.

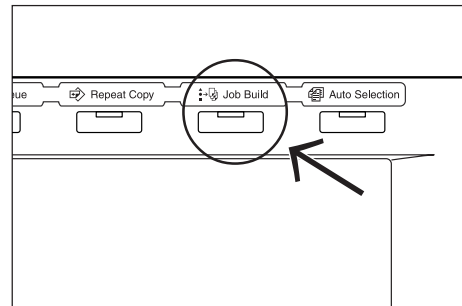

● Making the settings that apply to all steps

First, the settings for the 2-sided copy modes and the repeat copy mode must be made.

NOTES

- The repeat copy mode is used to enable you to make an additional number of copy sets later.
- It is also possible to select other settings and functions, as desired, besides those given in the example procedure. (See "(2) Selecting the settings and functions" on page 5-62.)

- 2 Touch the "1 sided/2 sided" key.
The "1 sided/2 sided" screen will be displayed.

Inch specifications

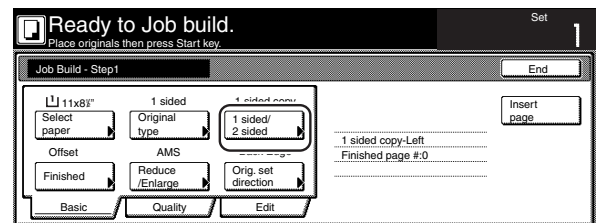

Metric specifications

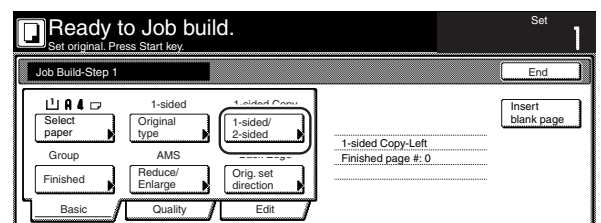

Section 5 OTHER CONVENIENT FUNCTIONS

- 3** Touch the “2 sided copy” key and then touch the “Open from left” [“Left binding”] key. Finally, touch the “Close” key. The touch panel will return to the screen in step 2.

Inch specifications

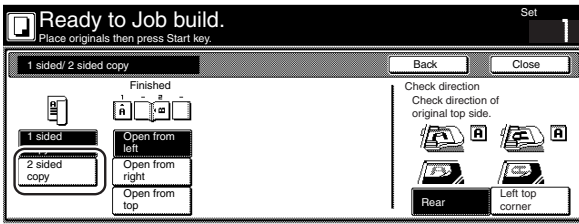

Metric specifications

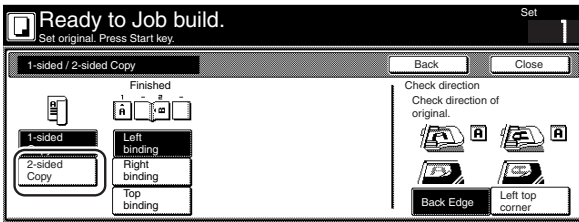

- 4** Touch the “Edit” key. Then, in the resulting screen, touch the “Modify Copy” key. The “Modify Copy” screen will be displayed.

Inch specifications

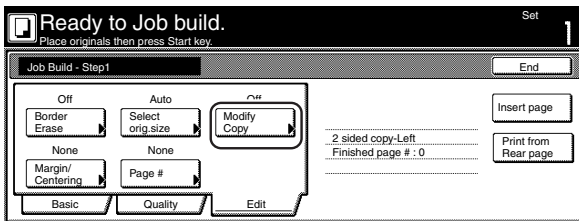

Metric specifications

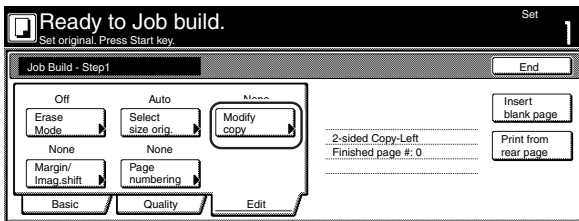

- 5** Touch the “On” key. Touch the “Close” key. The touch panel will return to the screen in step 4.

Inch specifications

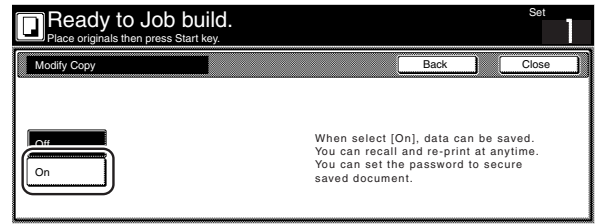

Metric specifications

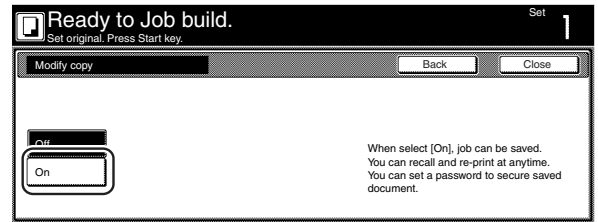

- Making the settings for the first original (“A” in the illustration on page 5-57.) The multi-bypass is to be selected for color paper feed under the “Select paper” screen.

- 6** Touch the “Select paper” key. The “Select paper” screen will be displayed.

Inch specifications

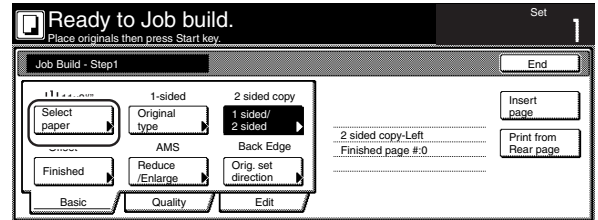

Metric specifications

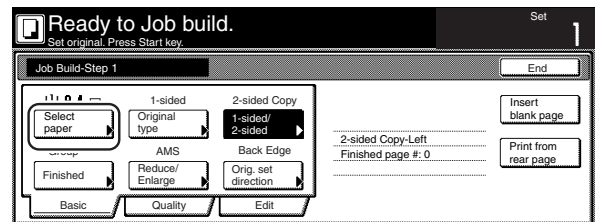

- 7 Touch the "Bypass" key. Touch the "Close" key. The touch panel will return to the screen in step 6.

Inch specifications

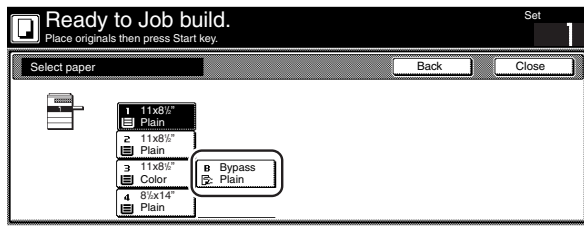

Metric specifications

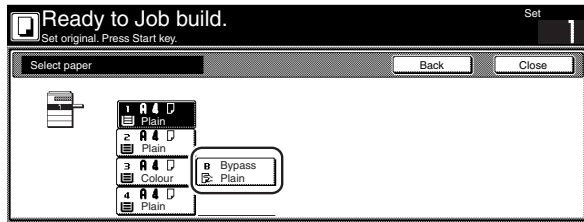

- 8 Set the first original ("A") to be copied. Press the [Start] key. Scanning of the originals will start.

- Step 2: Leaving the back side of the first original ("A") blank

- 9 Touch the "Print from Front page" key. Leaving the back side of the original blank will allow the next copy to start on the front side of the next page.

Inch specifications

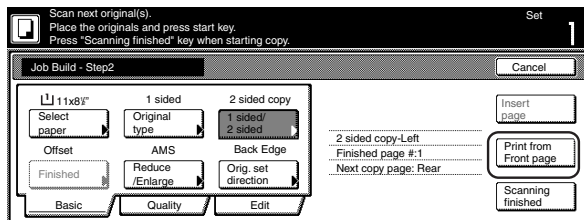

Metric specifications

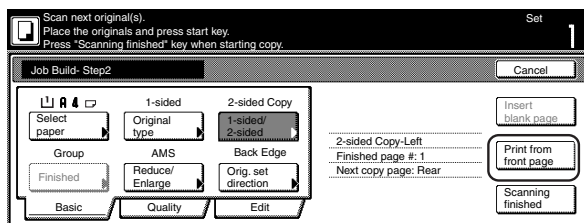

- Step 3: Making the settings for the second originals ("B" in the illustration on page 5-57.)
Drawer[Cassette] No.1 is to be selected for plain paper feed under the "Select paper" screen.

- 10 Touch the "Select paper" key. The "Select paper" screen will be displayed.

Inch specifications

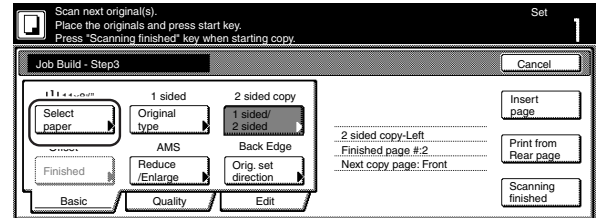

Metric specifications

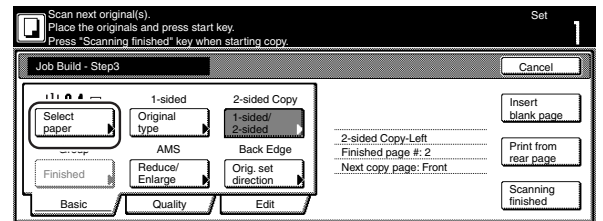

- 11 Touch the key that corresponds to drawer[cassette] No. 1. Touch the "Close" key. The touch panel will return to the screen in step 10.

Inch specifications

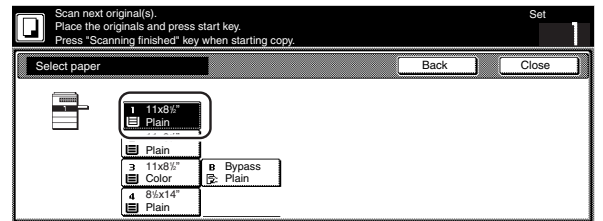

Metric specifications

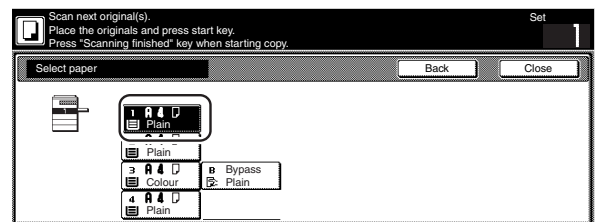

- 12 Set the second originals ("B") to be copied. Press the [Start] key. Scanning of the originals will start.

Section 5 OTHER CONVENIENT FUNCTIONS

- Step 4: Making the settings for the third original (“C” in the illustration on page 5-57.)

The multi-bypass is to be selected for color paper feed under the “Select paper” screen.

- 13 Touch the “Select paper” key. The “Select paper” screen will be displayed.

Inch specifications

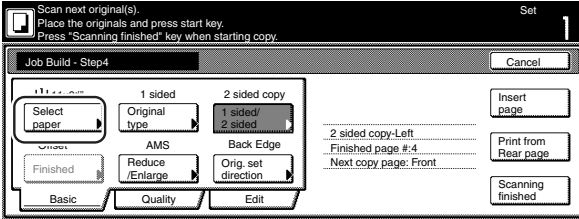

Metric specifications

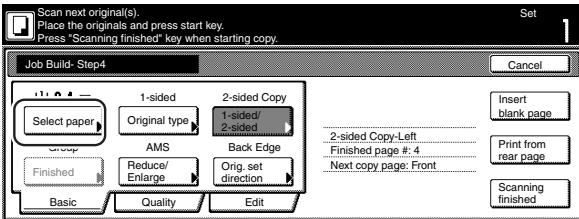

- 14 Touch the “Bypass” key. Touch the “Close” key. The touch panel will return to the screen in step 13.

Inch specifications

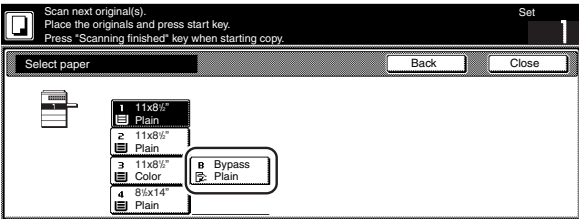

Metric specifications

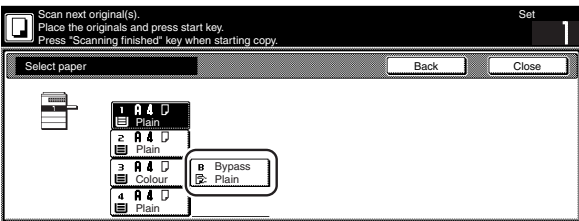

- 15 Set the third original (“C”) to be copied. Press the [Start] key. Scanning of the original will start.

- Step 5: Leaving the back side of the third original (“C”) blank

- 16 Touch the “Print from Front page” key. Leaving the back side of the original blank will allow the next copy to start on the front side of the next page.

Inch specifications

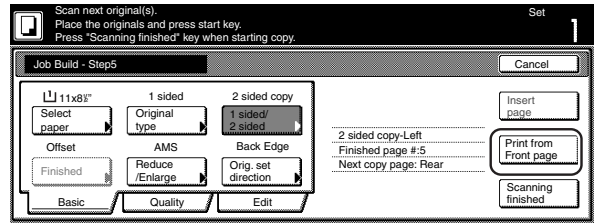

Metric specifications

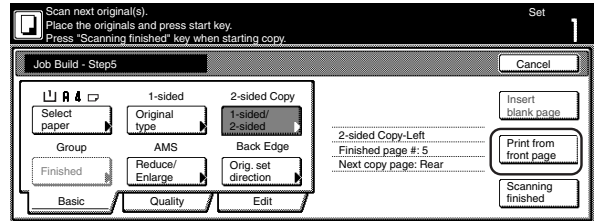

- Step 6: Making the settings for the fourth originals (“D” in the illustration on page 5-57.)
- Drawer[Cassette] No.1 is to be selected for plain paper feed under the “Select paper” screen.

- 17 Touch the “Select paper” key. The “Select paper” screen will be displayed.

Inch specifications

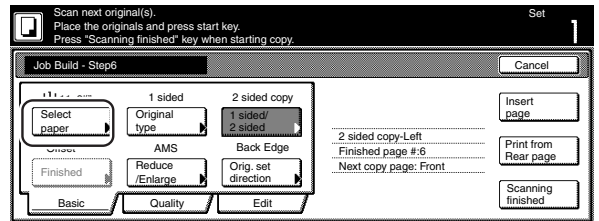

Metric specifications

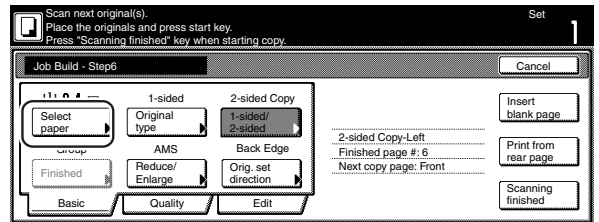

- 18** Touch the key that corresponds to drawer[cassette] No. 1.
 Touch the “Close” key. The touch panel will return to the screen in step 17.

Inch specifications

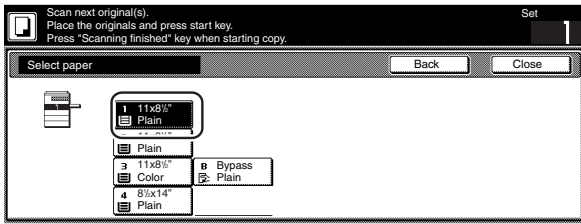

Metric specifications

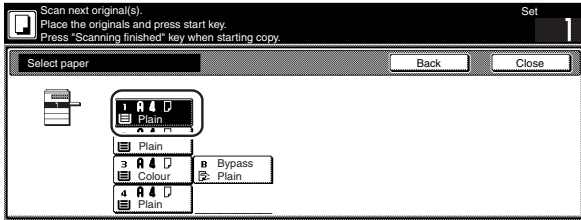

- 19** Set the fourth originals (“D”) to be copied. Press the [Start] key.
 Scanning of the originals will start.

- Step 7: Making the settings for a blank rear cover
 The multi-bypass is to be selected for color paper feed under the “Select paper” screen.

- 20** Touch the “Select paper” key. The “Select paper” screen will be displayed.

Inch specifications

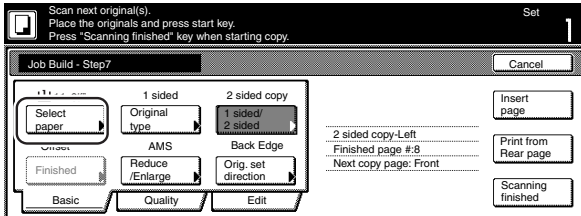

Metric specifications

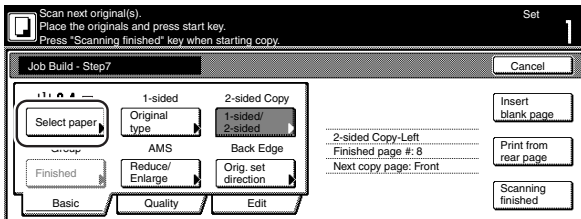

- 21** Touch the “Bypass” key.
 Touch the “Close” key. The touch panel will return to the screen in step 20.

Inch specifications

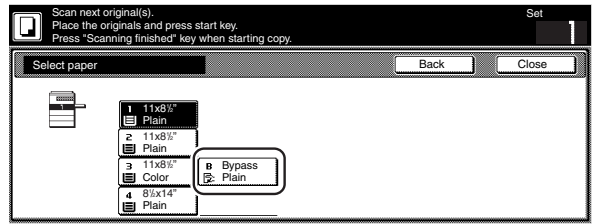

Metric specifications

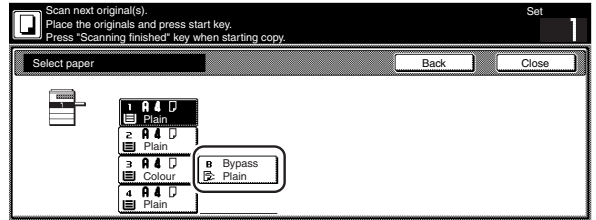

- 22** Touch the “Insert page” [“Insert blank page”] key.

Inch specifications

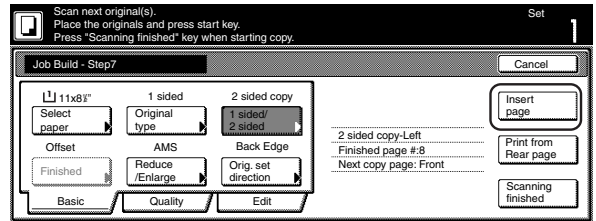

Metric specifications

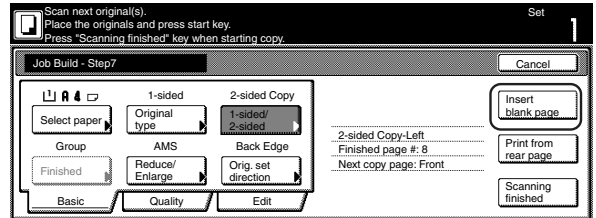

- 23** The job build set-up procedure is complete. Touch the “Scanning finished” key. Copying will start.

Inch specifications

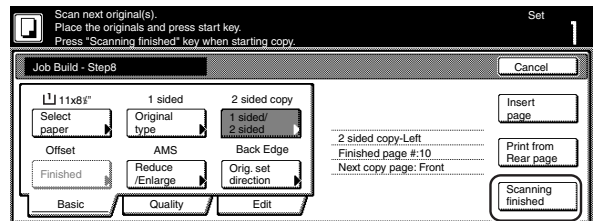

Metric specifications

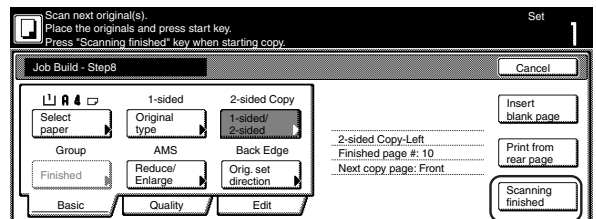

Section 5 OTHER CONVENIENT FUNCTIONS

- 24** If there are no problems with the copy set you made, then you can use the repeat copy mode to make any additional number of copy sets as desired (see “(2) Printing out with the repeat copy mode” on page 5-43).

(2) Selecting the settings and functions

① Selecting the paper

This procedure selects the size of the copy paper.

- 1** With the content of the “Basic” tab displayed, touch the “Select paper” key. The “Select paper” screen will be displayed.

Inch specifications

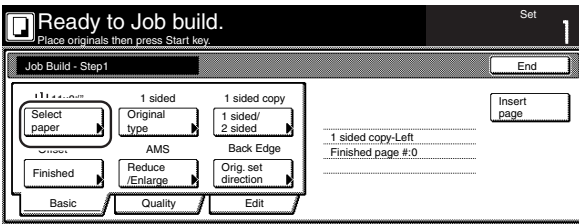

Metric specifications

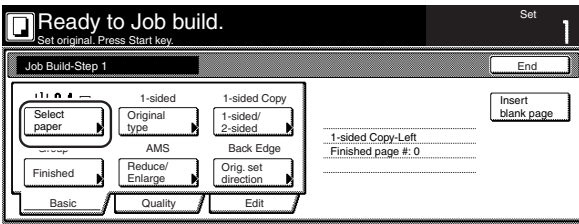

- 2** Touch the key that corresponds to the drawer[cassette] which contains the desired size of copy paper, and then touch the “Close” key. The touch panel will return to the screen in step 1.

Inch specifications

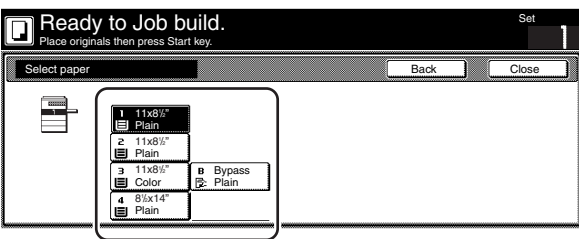

Metric specifications

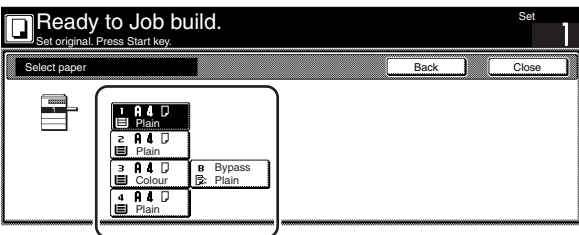

② Specifying the type of originals

This procedure specifies the type of originals being copied between 1-sided, 2-sided and open-faced.

- 1** With the content of the “Basic” tab displayed, touch the “Original type” key. The “Original type” screen will be displayed.

Inch specifications

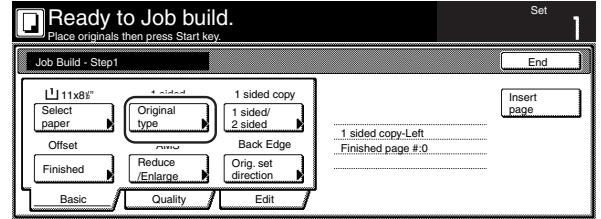

Metric specifications

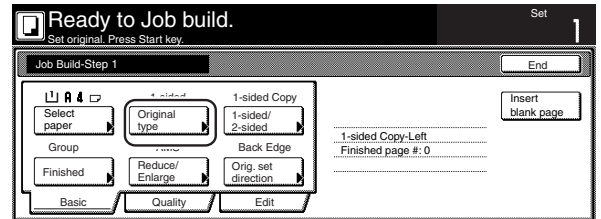

- 2** Select between “1 sided”, “2 sided” and “Book”, in accordance with the originals being copied.

Inch specifications

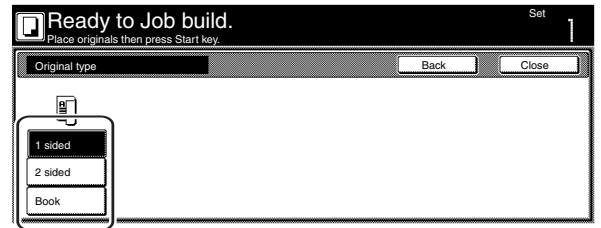

Metric specifications

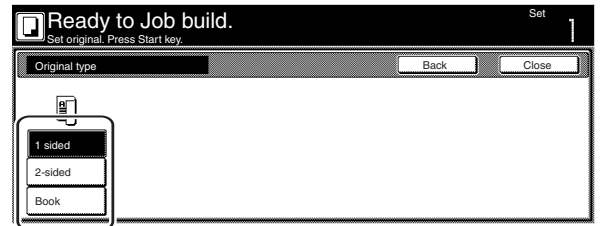

NOTES

- If you selected “1 sided”, verify the direction in which the originals were set.
- If you selected “2 sided”, specify the binding direction of the originals and then verify the direction in which the originals were set.
- If you selected “Book”, specify the binding direction of the originals.

- 3** Touch the “Close” key. The touch panel will return to the screen in step 1.

③ Selecting between 1-sided or 2-sided copies
 This procedure selects the type of finished copies to be made between 1-sided and 2-sided.

1 With the content of the “Basic” tab displayed, touch the “1 sided/2 sided” key. The “1 sided/2 sided” screen will be displayed.

Inch specifications

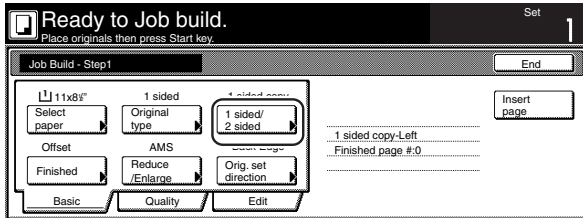

Metric specifications

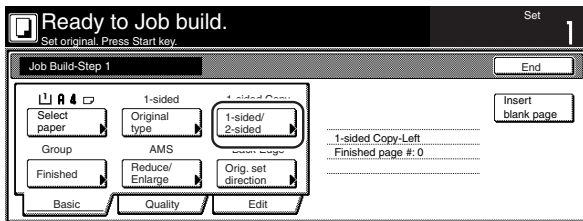

NOTE

The setting in regard to making either 1-sided or 2-sided copies can only be made in the first step of the job build mode and will apply to all steps in the copy job.

2 Touch the “1 sided” key or the “2 sided” key, as appropriate, and then select the binding direction you want for the finished copies.
 Follow the instructions on the right side of the touch panel and verify the direction in which the originals were set.

Inch specifications

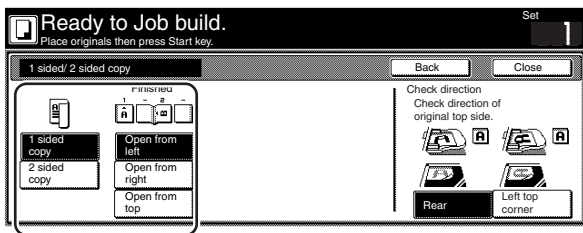

Metric specifications

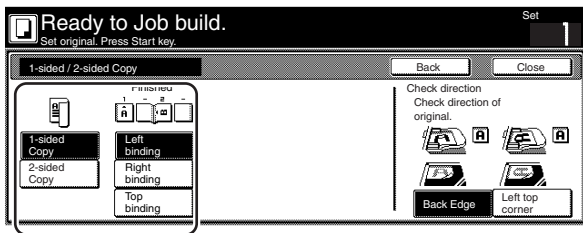

IMPORTANT!

If the designation for the direction that the originals are set is not correct, copying may be accomplished incorrectly.

3 Touch the “Close” key. The touch panel will return to the screen in step 1.

④ Selecting how to finished up the copy sets
 If the optional Document Finisher is installed on your copier, this procedure lets you select whether to staple or hole punch the finished copy sets.

1 With the content of the “Basic” tab displayed, touch the “Finished” key. The “Finished” screen will be displayed.

Inch specifications

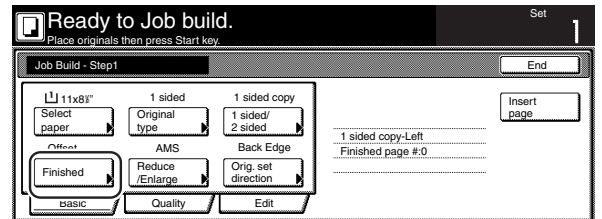

Metric specifications

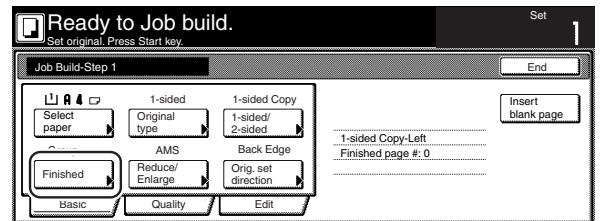

NOTE

The setting in regard to how the copy sets will be finished can only be made in the first step of the job build mode and will apply to all steps in the copy job.

Section 5 OTHER CONVENIENT FUNCTIONS

- 2 Select how you want the copy sets to be finished by touching the “Staple mode” key, the “Saddle Stitch” [“Center Staple”] key or the “Punch mode” key, as appropriate.

Follow the instructions on the right side of the touch panel and verify the direction in which the originals were set.

Inch specifications

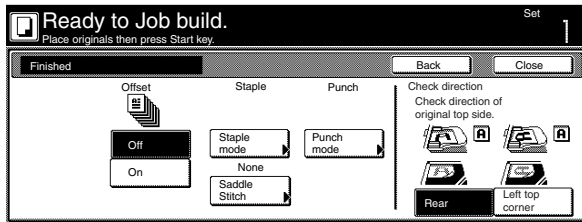

Metric specifications

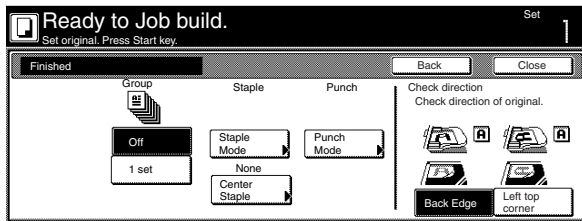

IMPORTANT!

If the designation for the direction that the originals are set is not correct, copying may be accomplished incorrectly.

- 3 Touch the “Close” key. The touch panel will return to the screen in step 1.

- 5 Making copies at an enlarged or reduced magnification ratio
This procedure selects the magnification ratio of the finished copies.

- 1 With the content of the “Basic” tab displayed, touch the “Reduce/Enlarge” key. The “Reduce/Enlarge” screen will be displayed.

Inch specifications

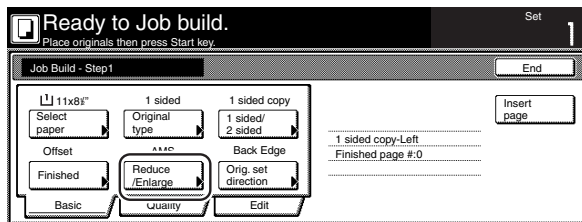

Metric specifications

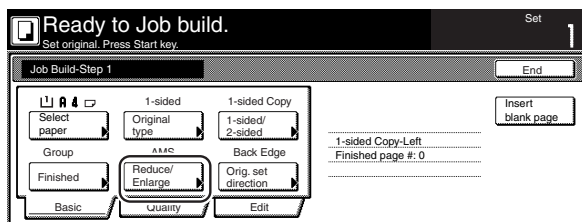

- 2 Select the desired magnification ratio.
If you want to have the copy magnification ratio selected automatically, touch the “AMS” key.
If you want to manually set the magnification ratio, touch the “# keys” [“#-Keys”] key and then enter the desired ratio with the keypad, or touch the “+” key or the “-” key to change the displayed magnification ratio to the desired setting in 1% increments.

You can also select the magnification ratio by touching the preset zoom ratio keys at the right that corresponds to the desired ratio.

Inch specifications

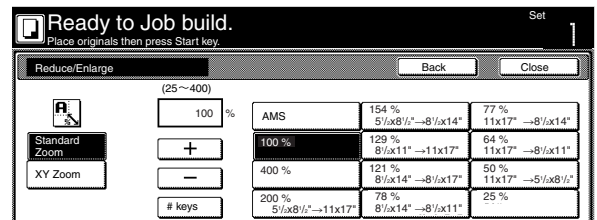

Metric specifications

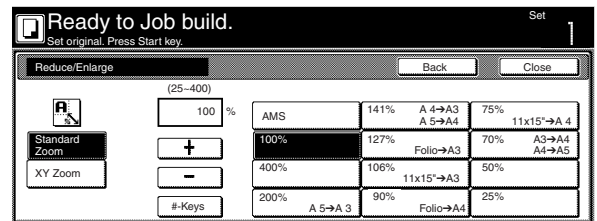

Metric specifications (Asia Pacific)

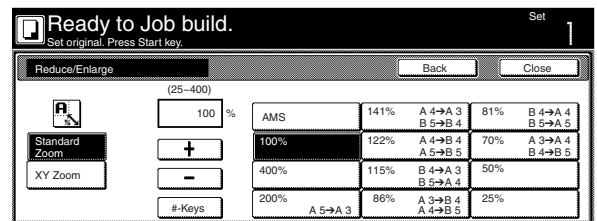

- 3 Touch the “Close” key. The touch panel will return to the screen in step 1.

⑥ Specifying the direction that the originals were set
This procedure specifies the direction of the set originals.

- 1 With the content of the “Basic” tab displayed, touch the “Orig.set direction” key. The “Orig.set direction” screen will be displayed.

Inch specifications

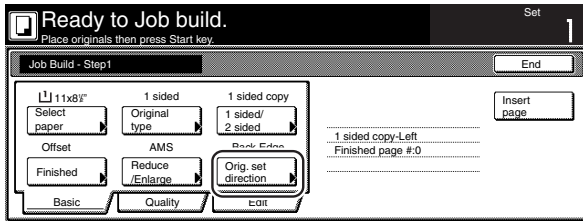

Metric specifications

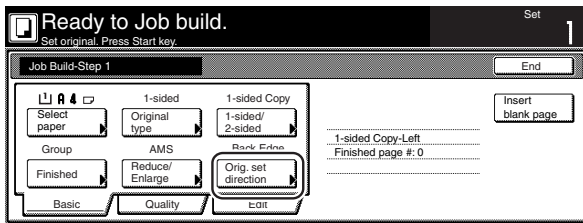

- 2 Touch the “Rear” [“Back Edge”] key or the “Left top corner” key, as appropriate, according to the direction of the originals.

Inch specifications

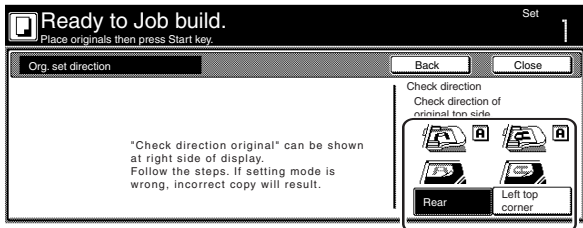

Metric specifications

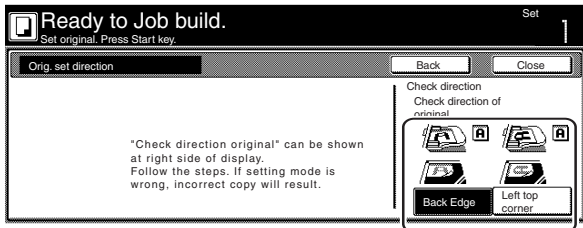

IMPORTANT!

If the designation for the direction that the originals are set is not correct, copying may be accomplished incorrectly.

- 3 Touch the “Close” key. The touch panel will return to the screen in step 1.

⑦ Setting the scanning density
This procedure sets the copy exposure for the finished copies.

- 1 Touch the “Quality” key. Then, in the resulting screen, touch the “Exposure mode” key. The “Exposure mode” screen will be displayed.

Inch specifications

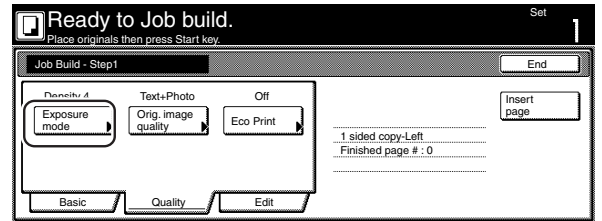

Metric specifications

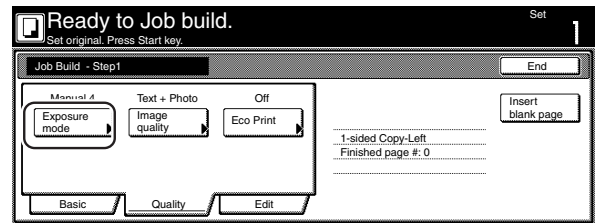

- 2 If you want to have the copy exposure selected automatically, touch the “Auto” key. If you want to manually set the exposure, touch the “Manual” key and then touch the “Lighter” key or the “Darker” key to move the cursor on the exposure scale and adjust the exposure as desired.

Inch specifications

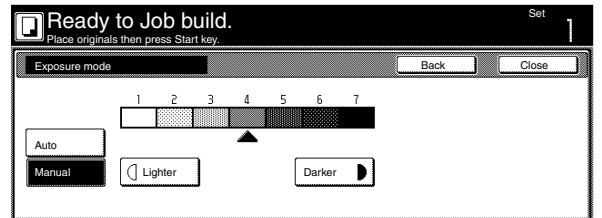

Metric specifications

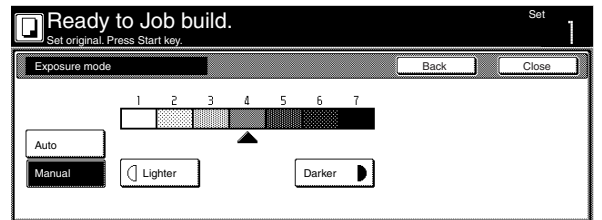

- 3 Touch the “Close” key. The touch panel will return to the screen in step 1.

Section 5 OTHER CONVENIENT FUNCTIONS

⑧ Setting the image quality

This procedure sets the image quality according to the type of originals being copied.

- 1 Touch the "Quality" key. Then, in the resulting screen, touch the "Orig. image quality" key. The "Orig. image quality" screen will be displayed.

Inch specifications

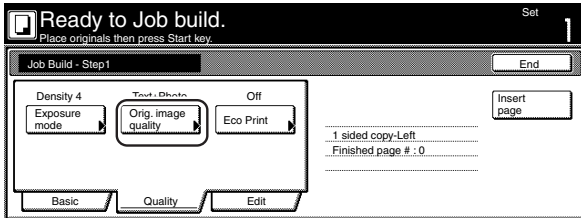

Metric specifications

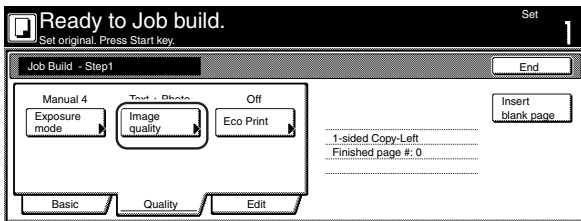

- 2 Select the image quality mode by touching the "Manual" key and then touching the "Text+Photo" key, the "Photo" key or the "Text" key, as appropriate.

Inch specifications

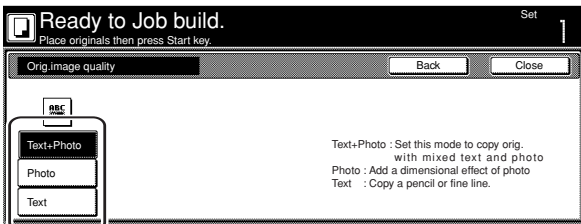

Metric specifications

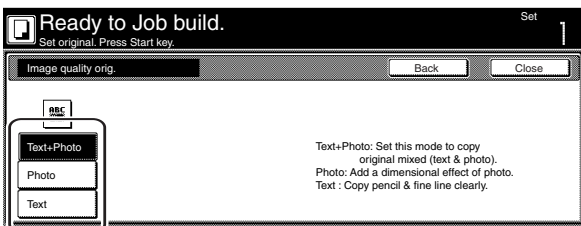

- 3 Touch the "Close" key. The touch panel will return to the screen in step 1.

⑨ Turning the eco print mode ON

This procedure allows you to turn the eco print mode ON in order to save on toner use.

- 1 Touch the "Quality" key. Then, in the resulting screen, touch the "Eco Print" key. The "Eco Print" screen will be displayed.

Inch specifications

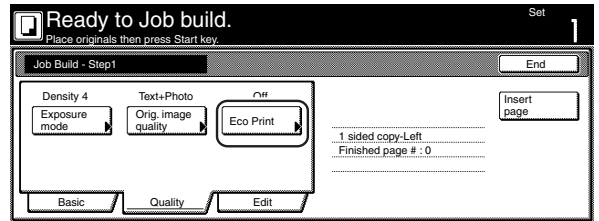

Metric specifications

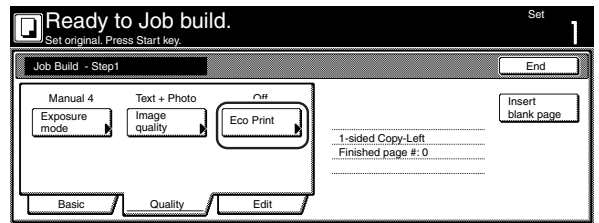

NOTE

The setting in regard to whether or not to use the eco print mode can only be made in the first step of the job build mode and will apply to all steps in the copy job.

- 2 Touch the "On" key to turn the eco print mode ON.

Inch specifications

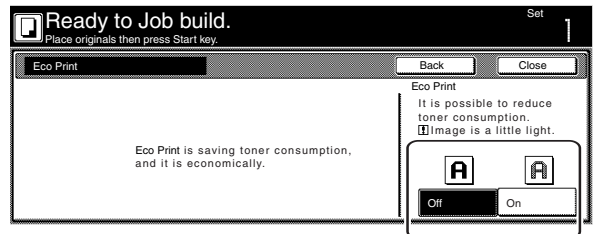

Metric specifications

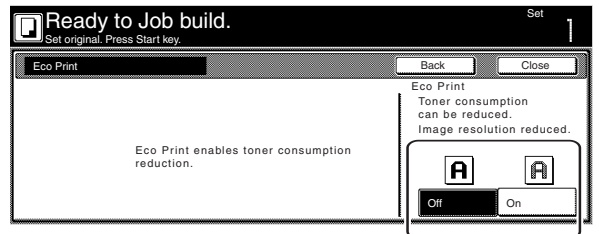

- 3 Touch the "Close" key. The touch panel will return to the screen in step 1.

Section 5 OTHER CONVENIENT FUNCTIONS

⑩ Selecting the sheet erase mode

This procedure selects the sheet erase mode in order to erase the shadows, lines, etc., that can occur around the edges of copies.

- 1 Touch the "Edit" key. Then, in the resulting screen, touch the "Border Erase" ["Erase Mode"] key. The "Border Erase" ["Erase Mode"] screen will be displayed.

Inch specifications

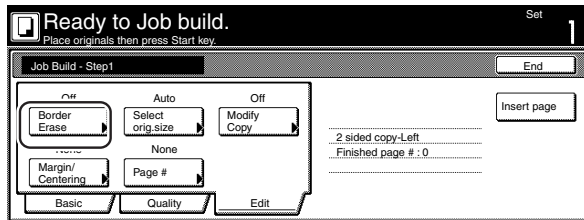

Metric specifications

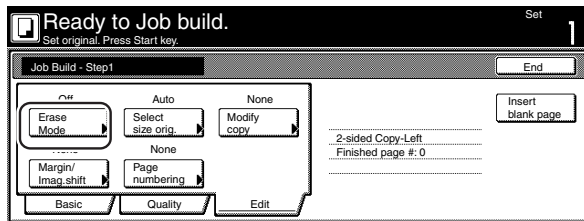

- 2 Touch the "Sheet Erase" ["Border erase"] key or "Individual BordrErase" ["Individual Erase Mode"] key and then set the desired border width.

Inch specifications

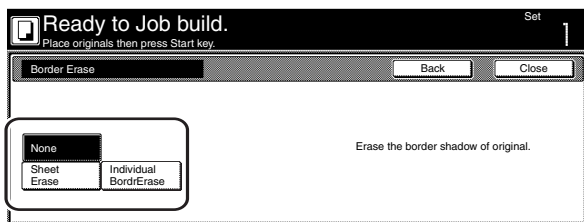

Metric specifications

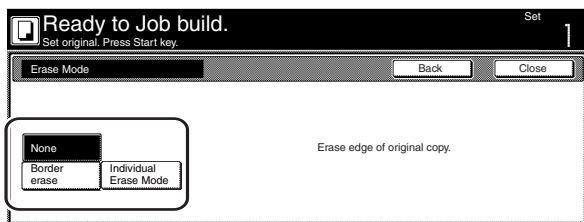

- 3 Touch the "Close" key. The touch panel will return to the screen in step 1.

⑪ Manually selecting the size of the originals

This procedure allow you to select the size of the originals manually using the touch panel.

- 1 Touch the "Edit" key. Then, in the resulting screen, touch the "Select orig. size" ["Select size orig."] key. The "Select original size" ["Select size original"] screen will be displayed.

Inch specifications

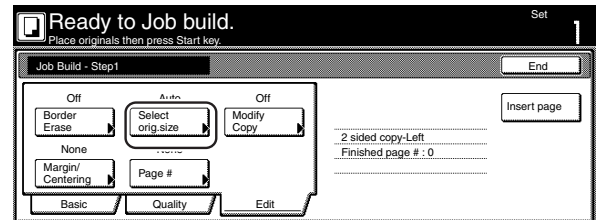

Metric specifications

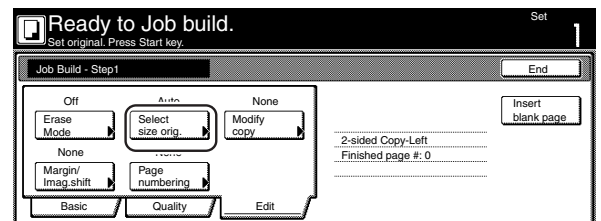

- 2 If you want the size of the originals to be detected automatically, touch the "Auto" key. If you want to select a standard original size, touch the key that corresponds to the desired size.

If you want to select another standard original size, touch the "Other stand. Size" ["Others stand. Size"] key and select the desired size.

If you want to select the dimensions of the originals manually, touch the "Input size" key and then set the corresponding dimensions.

Inch specifications

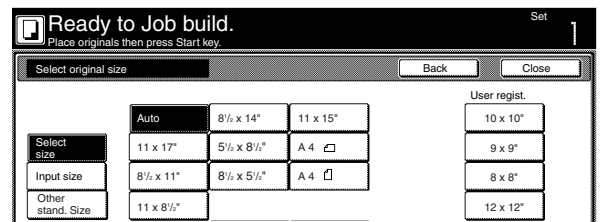

Metric specifications

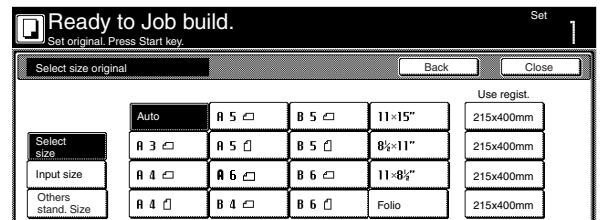

- 3 Touch the "Close" key. The touch panel will return to the screen in step 1.

Section 5 OTHER CONVENIENT FUNCTIONS

⑫ Selecting the repeat copy mode

This procedure allow you to select the repeat copy mode so that you can make any necessary number of additional copies later.

- 1 Touch the “Edit” key. Then, in the resulting screen, touch the “Modify Copy” key. The “Modify Copy” screen will be displayed.

Inch specifications

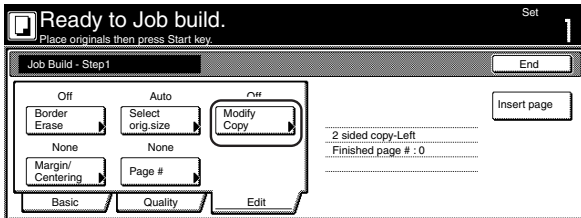

Metric specifications

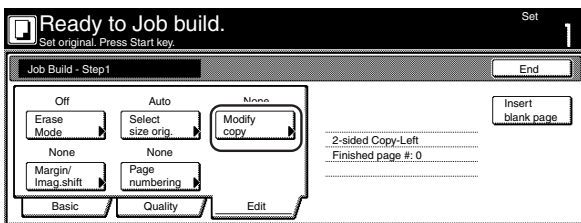

⑬ Selecting the margin mode or the centering/image shift mode

This procedure selects the margin mode or the centering/image shift mode in order to create a margin space or center the copy image.

- 1 Touch the “Edit” key. Then, in the resulting screen, touch the “Margin/Centering” [“Margin/Imag. shift”] key. The “Margin/Centering” [“Margin/Imag. shift”] screen will be displayed.

Inch specifications

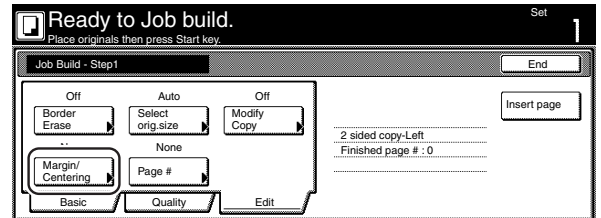

Metric specifications

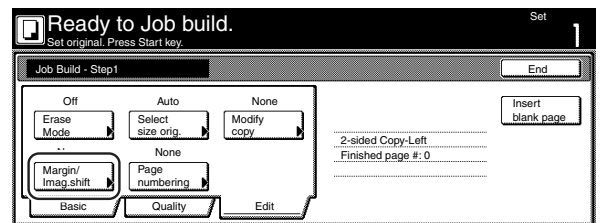

NOTES

- To make additional copies with the repeat copy mode, refer to “(2) Printing out with the repeat copy mode” on page 5-43.
- The setting in regard to whether or not to use the repeat copy mode can only be made in the first step of the job build mode and will apply to all steps in the copy job.

NOTE

The setting in regard to the margin mode or the centering/image shift mode can only be made in the first step of the job build mode and will apply to all steps in the copy job.

- 2 Touch the “On” key to select the repeat copy mode.

Inch specifications

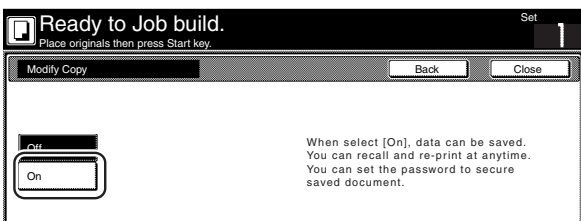

Metric specifications

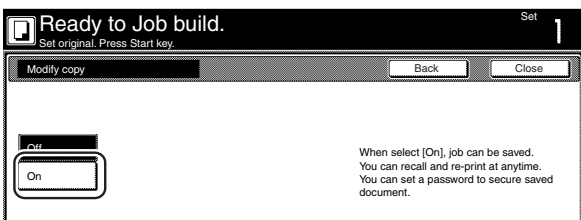

- 3 Touch the “Close” key. The touch panel will return to the screen in step 1.

- 2 Touch the “Margin” key or the “Centering” [“Imag.shift”] key, as appropriate.

For more detailed information on these two settings, refer to the explanation for the margin mode on page 5-6 or the centering/image shift mode on page 5-8, as appropriate.

Inch specifications

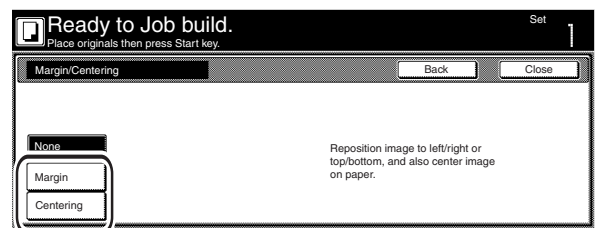

Metric specifications

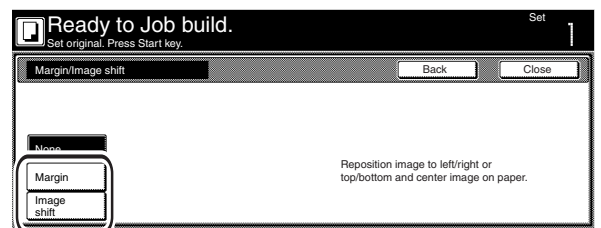

- 3 Touch the “Close” key. The touch panel will return to the screen in step 1.

14 Selecting the print page numbers mode

This procedure selects the print page numbers mode in order to have page numbers printed on the corresponding copies.

- 1 Touch the “Edit” key. Then, in the resulting screen, touch the “Page #” [“Page numbering”] key. The “Page #” [“Page numbering”] screen will be displayed.

Inch specifications

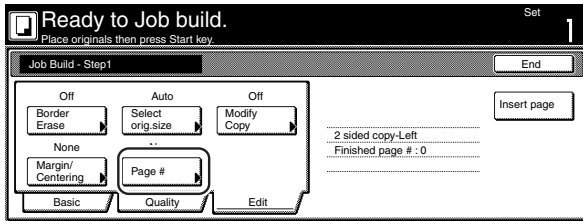

Metric specifications

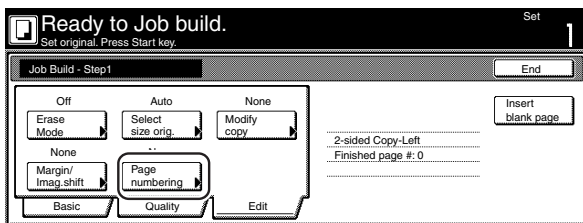

NOTE

The setting in regard to the print page numbers mode can only be made in the first step of the job build mode and will apply to all steps in the copy job.

- 2 For more detailed information on this setting, refer to the explanation for the print page numbers mode on page 5-16.

Inch specifications

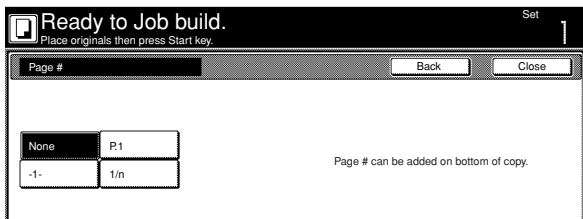

Metric specifications

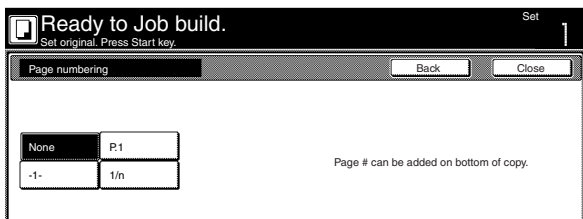

- 3 Touch the “Close” key. The touch panel will return to the screen in step 1.

Section 6 DOCUMENT AND OUTPUT MANAGEMENT FUNCTIONS

1. Document management functions

NOTE

The optional Hard Disk must be installed on this copier in order to use this function.

(1) What are the “document management” functions?

“Document management” functions refer to those functions that enable you to scan and save documents onto the copier’s hard disk, and then use that data for copying purposes. Each function has its own separate “box” (the area where document data is saved) on the hard disk and all data for that particular function is saved into that specific box.

The following “document management” functions are available with this copier:

- **Form registration (pages 6-1 through 6-4)**

You can store in a box on the copier’s hard disk, and you can then manage the use of, those images that will be used as the “form” in the form overlay mode.

- **Shared data box (pages 6-4 through 6-8)**

If you register data that will be shared by all users in the shared data box, it will be possible for each user to print out that data at their own convenience. This is useful, for example, for registering business forms and the like that are frequently used by many people. The data that you register here will be stored permanently until the procedure to delete it is performed.

- **Synergy print boxes (pages 6-9 through 6-19)**

If you store multiple sets of documents in a synergy print box, you can print out up to 10 of these sets at one time.

(2) Form registration

① Registering a form

Perform the following procedure when you want to register an image as a “form” for use in the form overlay mode.

- 1 Set the document that you want to register as a form.
- 2 Press the [Document Management] key. The “Document Management” screen will be displayed.

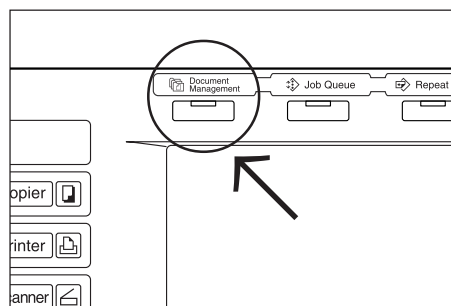

- 3 Touch the “Form reg.” [“Form registr.”] key. The “Form registration” screen will be displayed.

Inch specifications

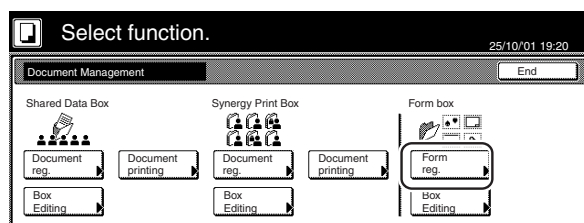

Metric specifications

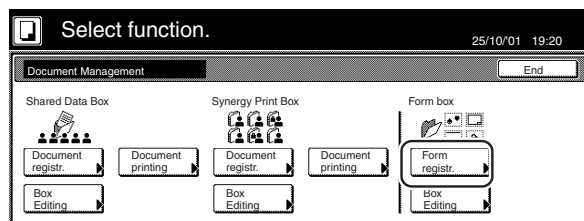

Section 6 DOCUMENT AND OUTPUT MANAGEMENT FUNCTIONS

- 4** Touch the “Change name” key and then enter a name for the form data.

If you do not want to register a name for the form data, go directly to the next step.

Inch specifications

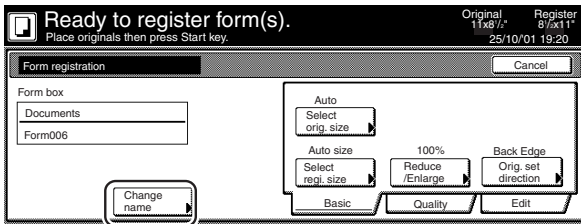

Metric specifications

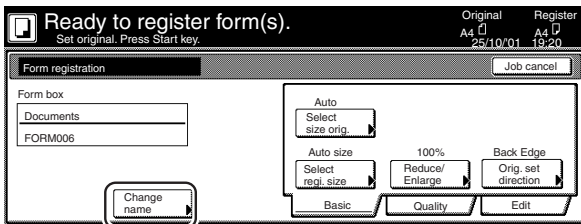

- 2** Checking registered forms and changing form names

Perform the following procedure when you want to verify the name of a registered form, the size of the original document or the date and time it was stored in memory, or when you want to print out the document in order to check it. You can also use this procedure to change the registered form name.

- 1** Press the [Document Management] key. The “Document Management” screen will be displayed.

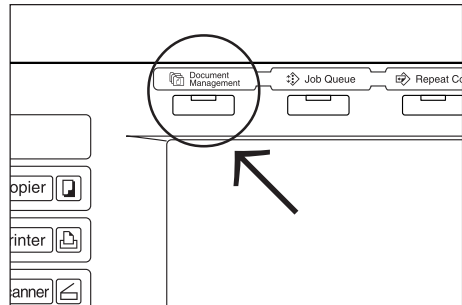

- 2** Touch the “Box Editing” key under “Form box”. The “Box editing” screen will be displayed.

Inch specifications

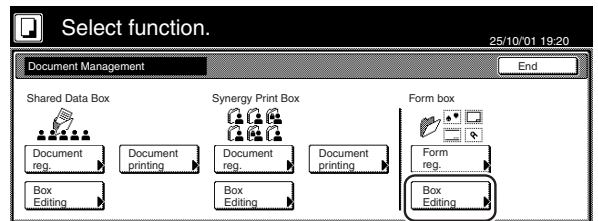

Metric specifications

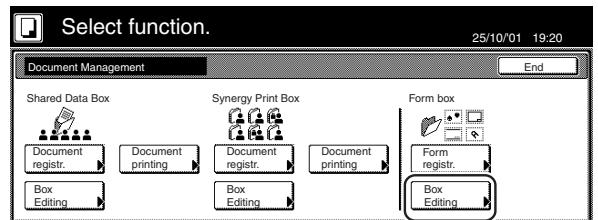

- 3** Select the form that you want to check and then touch the “Conf/Crrt. details” [“Check/Rev. details”] key. The “Check/Correct details” [“Check/revise details”] screen will be displayed.

Inch specifications

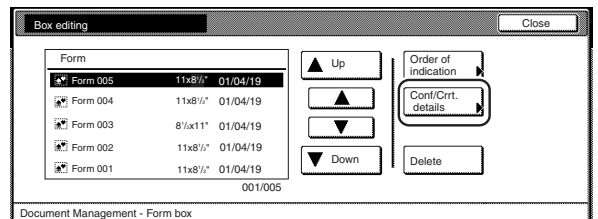

Metric specifications

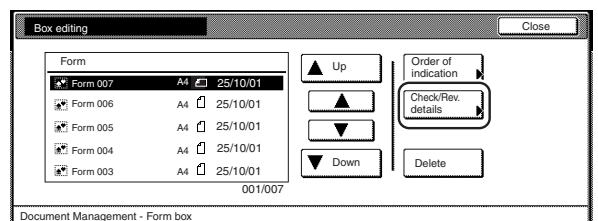

NOTE

Refer to “11. Entering characters” on page 7-104 for information on entering characters.

- 5** Touch the “Select orig. size” [“Select size orig.”], “Select regi. size”, “Reduce/Enlarge” and/or “Orig. set direction” keys if you want to perform the corresponding settings for the originals being used.

If you want to access the “Scanning density” key and/or the “Orig. image quality” [“Image quality”] key to make those settings, touch the “Quality” key.

If you want to set access the “Border Erase” [“Erase Mode”] key to make those settings, touch the “Edit” key.

- 6** Press the [Start] key. Scanning of the document will start. Once the document has been completely scanned, the touch panel will return to the screen in step 3.

If you want to register another form, repeat steps 3 through 6.

- 7** Touch the “End” key. The touch panel will return to the contents of the “Basic” tab.

NOTE

It is possible to change the order of display for the registered forms. To do so, touch the “Order of indication” key, and then touch the “Sort by date” key (and select either “New → Old” or “Old → New”) or the “Sort by name” key (and select either “A → Z” or “Z → A”), as appropriate.

- 4 Check the displayed information.
If you want to print out the selected form, touch the “Print Form” key.
If you want to change the name of the selected form, touch the “Change form name” key and then enter the new name.

Inch specifications

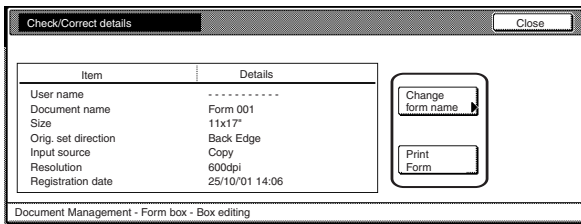

Metric specifications

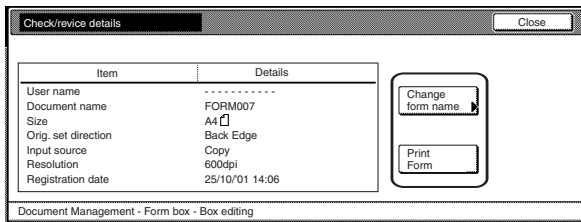

NOTE

Refer to “11. Entering characters” on page 7-104 for information on entering characters.

- 5 Once you have finished checking the information for that form, touch the “Close” key. The touch panel will return to the screen in step 3.
If you want to check the information for another registered form, repeat steps 3 through 5.

- 6 Touch the “Close” key once again. The touch panel will return to the screen in step 2.
Touch the “End” key. The touch panel will return to the contents of the “Basic” tab.

③ Deleting a registered form

Perform the following procedure when you want to delete a registered form.

- 1 Press the [Document Management] key. The “Document Management” screen will be displayed.

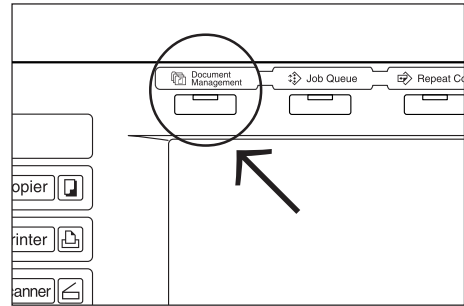

- 2 Touch the “Box Editing” key under “Form Box”. The “Box editing” screen will be displayed.

Inch specifications

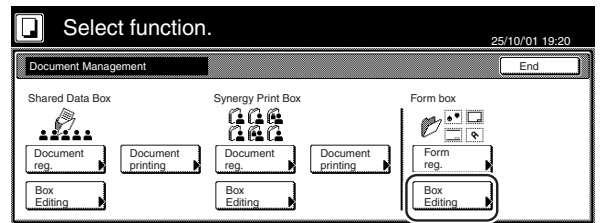

Metric specifications

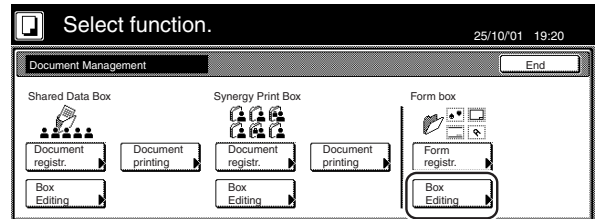

- 3 Select the form that you want to delete and then touch the “Delete” key. A verification screen will be displayed.

Inch specifications

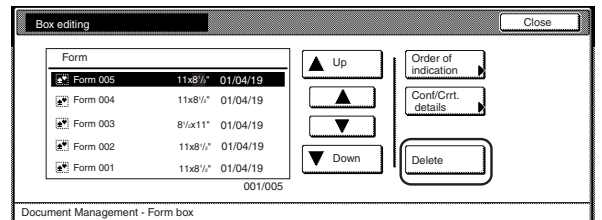

Metric specifications

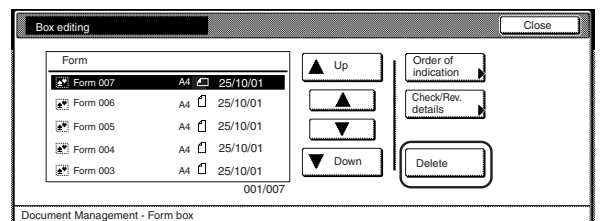

Section 6 DOCUMENT AND OUTPUT MANAGEMENT FUNCTIONS

NOTE

It is possible to change the order of display for the stored documents. To do so, touch the "Order of indication" key, and then touch the "Sort by date" key (and select either "New → Old" or "Old → New") or the "Sort by name" key (and select either "A → Z" or "Z → A"), as appropriate.

- 4** Touch the "Yes" key or the "No" key, as appropriate.
Inch specifications

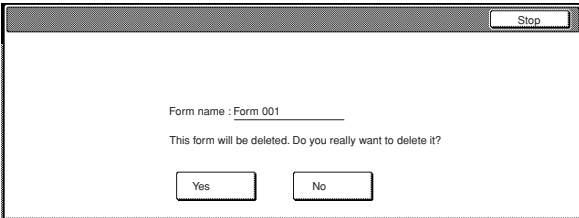

Metric specifications

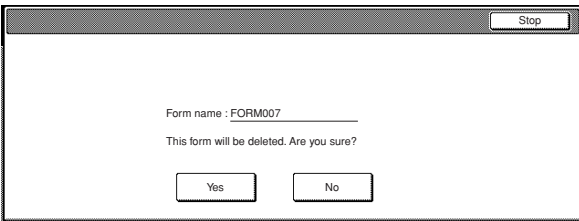

If you selected "Yes", the selected form will be deleted and the touch panel will return to the screen in step 3.
If you selected "No", the touch panel will return to the screen in step 3 without deleting the selected form.

- 5** If you want to delete another registered form, repeat steps 3 and 4.
- 6** Touch the "Close" key. The touch panel will return to the screen in step 2.
Touch the "End" key. The touch panel will return to the contents of the "Basic" tab.

(3) Shared data box

① Storing documents in the box

Perform the following procedure when you want to register a set of documents in the shared data box.

* Up to 100 sets of documents can be saved in the shared data box.

- 1** Set the documents to be stored.
- 2** Press the [Document Management] key. The "Document Management" screen will be displayed.

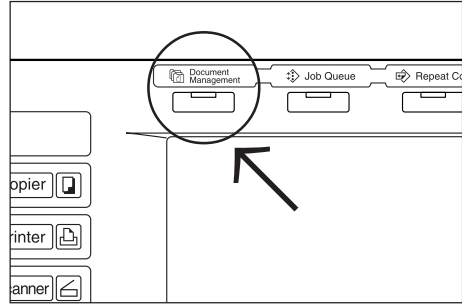

- 3** Touch the "Document reg." ["Document registr.,"] key under "Shared Data Box". The "Document registration" screen will be displayed.

Inch specifications

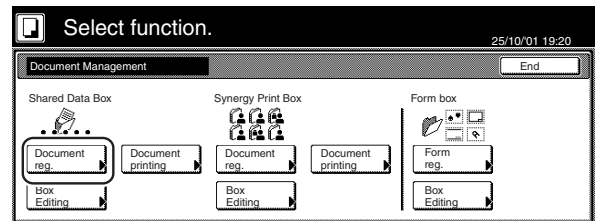

Metric specifications

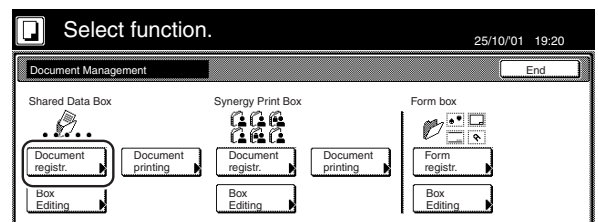

- 4 Touch the “Change name” key and then enter a name for the documents.
If you do not want to register a name for the documents, go directly to the next step.

Inch specifications

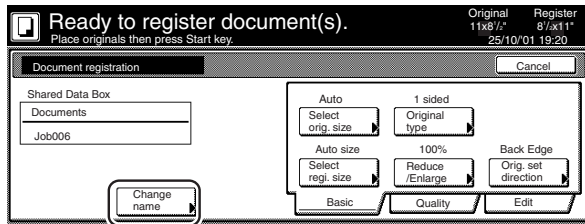

Metric specifications

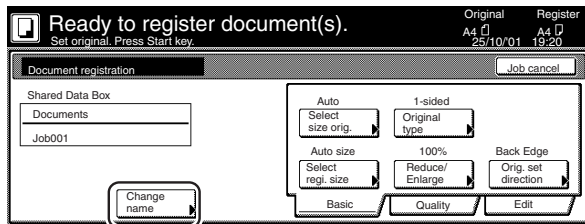

NOTE

Refer to “11. Entering characters” on page 7-104 for information on entering characters.

- 5 Touch the “Select orig. size” [“Select size orig.”] key, the “Select regi. size” key, the “Original type” key, the “Reduce/Enlarge” key and/or the “Orig.set direction” key, if you want to perform the corresponding settings.
If you want to access the “Scanning density” key and/or the “Orig.image quality” [“Image quality”] key to make those settings, touch the “Quality” key.
If you want to set access the “Border Erase” [“Erase Mode”] key and/or the “Continuous scanning” [“Multiple scanning”] key to make those settings, touch the “Edit” key.

- 6 Press the [Start] key. Scanning of the documents will start. Once all of the documents have been completely scanned, the touch panel will return to the screen in step 3.
If you want to register another document, repeat steps 3 through 6.

- 7 Touch the “End” key. The touch panel will return to the contents of the “Basic” tab.

② Printing out stored documents

Perform the following procedure when you want to print out documents that are stored in a shared data box.

- 1 Press the [Document Management] key. The “Document Management” screen will be displayed.

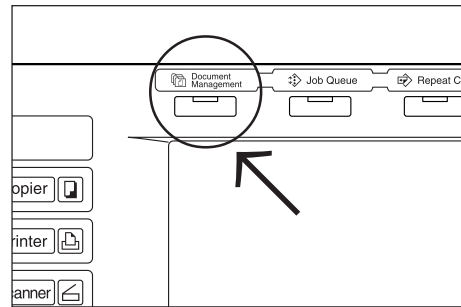

- 2 Touch the “Document printing” key under “Shared Data Box”. The “Document printing” screen will be displayed.

Inch specifications

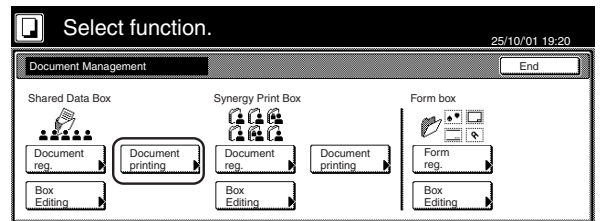

Metric specifications

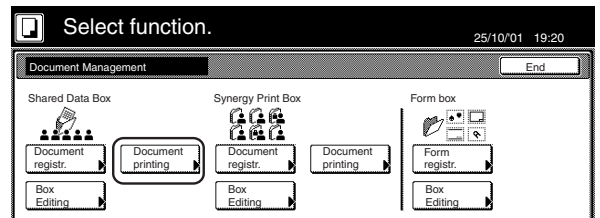

- 3 Select the documents to be printed out and then touch the “Finish selecting” key.

Inch specifications

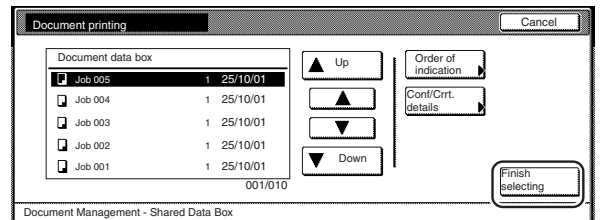

Metric specifications

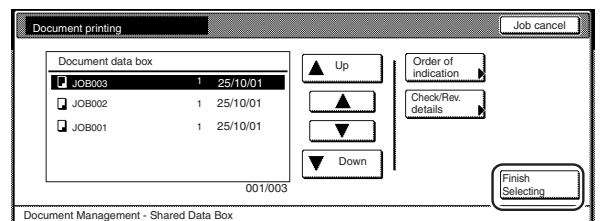

Section 6 DOCUMENT AND OUTPUT MANAGEMENT FUNCTIONS

NOTE

It is possible to change the order of display for the stored documents. To do so, touch the "Order of indication" key, and then touch the "Sort by date" key (and select either "New → Old" or "Old → New") or the "Sort by name" key (and select either "A → Z" or "Z → A"), as appropriate.

- 4 Touch the "Select paper" key, the "Sort/Finished" key and/or the "1 sided/ 2 sided" key, to perform the corresponding settings.

If you want to access the "Form Overlay" key, the "Margin" key, the "Cover Mode" key, the "Page #" ["Page numbering"] key, the "Booklet" key and/or the "Select of Output" key to make those settings, touch the "Edit" key.

- 5 Press the [Start] key. Print out will start.

③ Checking stored documents and changing their names

Perform the following procedure when you want to verify the name of stored documents, the size of the original documents or the date and time they were stored in the shared data box, or when you want to print out the first page of those document in order to check them. You can also use this procedure to change the registered name for the documents.

- 1 Press the [Document Management] key. The "Document Management" screen will be displayed.

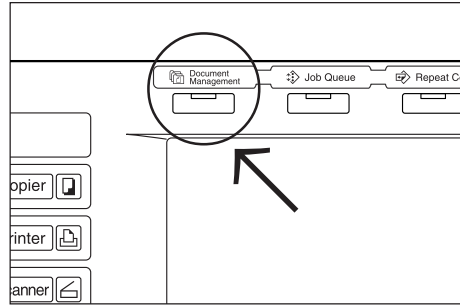

- 2 Touch the "Document printing" key or the "Box Editing" key under "Shared Data Box". The "Document printing" screen or the "Box editing" screen, as appropriate, will be displayed.

Inch specifications

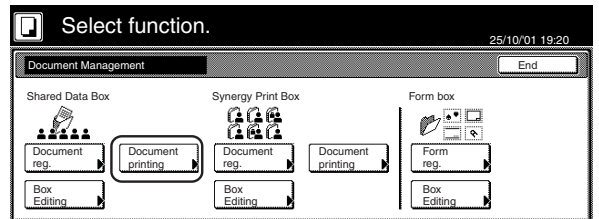

Metric specifications

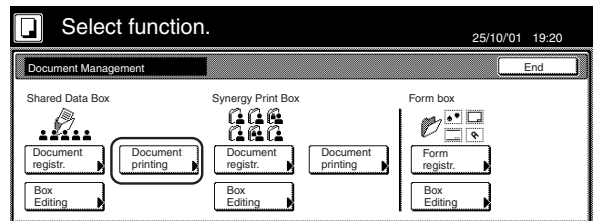

- 3 Select the documents that you want to check and then touch the “Cont/Crrt. details” [“Check/Rev. details”] key. The “Check/Correct details” [“Check/revise details”] screen will be displayed.

Inch specifications

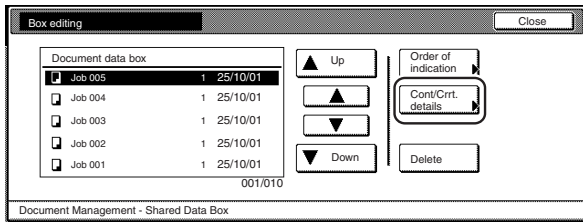

Metric specifications

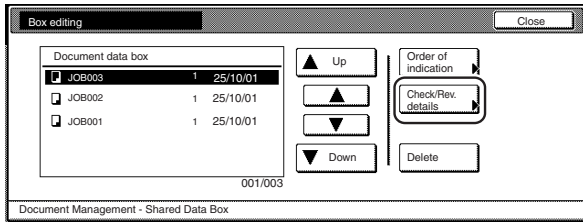

- 5 Once you have finished checking the information for those documents, touch the “Close” key. The touch panel will return to the screen in step 3. If you want to check the information for other stored documents, repeat steps 3 through 5.

- 6 Touch the “Close” key once again. The touch panel will return to the screen in step 2. Touch the “End” key. The touch panel will return to the contents of the “Basic” tab.

NOTE

It is possible to change the order of display for the stored documents. To do so, touch the “Order of indication” key, and then touch the “Sort by date” key (and select either “New → Old” or “Old → New”) or the “Sort by name” key (and select either “A → Z” or “Z → A”), as appropriate.

- 4 Check the displayed information. If you want to print out the first page of the selected documents, touch the “Print from 1st” [“Head Print”] key. If you want to change the name of the selected documents, touch the “Change doc.name” key and then enter the new name.

Inch specifications

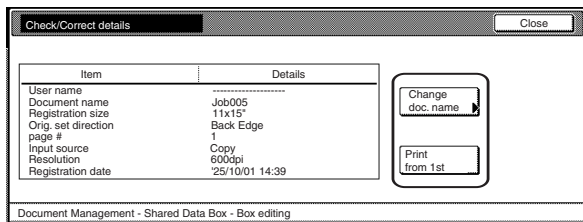

Metric specifications

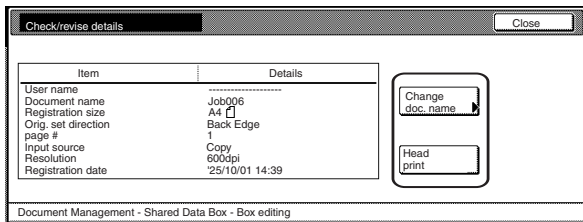

NOTE

Refer to “11. Entering characters” on page 7-104 for information on entering characters.

Section 6 DOCUMENT AND OUTPUT MANAGEMENT FUNCTIONS

④ Deleting stored documents

Perform the following procedure when you want to delete stored documents.

- 1 Press the [Document Management] key. The “Document Management” screen will be displayed.

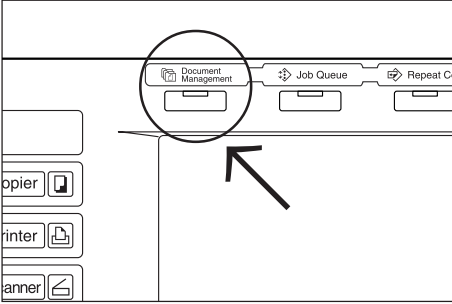

- 2 Touch the “Box Editing” key under “Shared Data Box”. The “Box editing” screen will be displayed.

Inch specifications

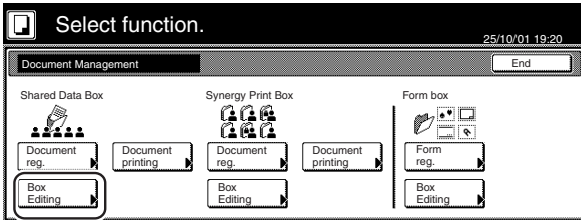

Metric specifications

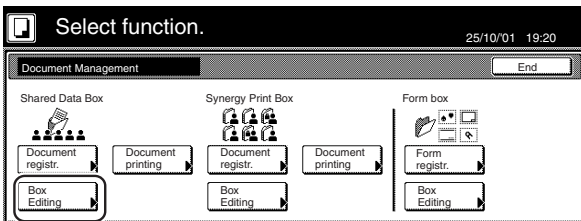

- 3 Select the documents that you want to delete and then touch the “Delete” key. A verification screen will be displayed.

Inch specifications

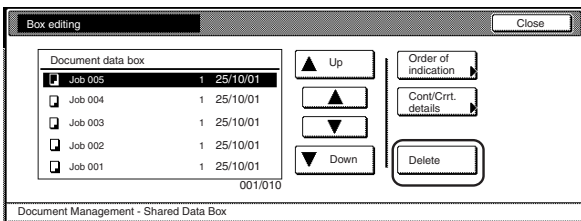

Metric specifications

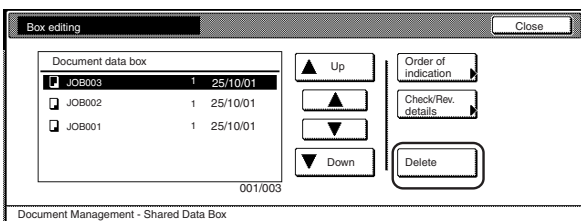

NOTE

It is possible to change the order of display for the stored documents. To do so, touch the “Order of indication” key, and then touch the “Sort by date” key (and select either “New → Old” or “Old → New”) or the “Sort by name” key (and select either “A → Z” or “Z → A”), as appropriate.

- 4 Touch the “Yes” key or the “No” key, as appropriate.

Inch specifications

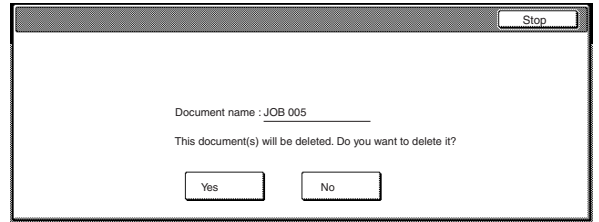

Metric specifications

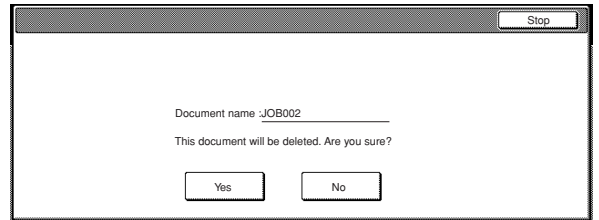

If you selected “Yes”, the selected documents will be deleted and the touch panel will return to the screen in step 3.

If you selected “No”, the touch panel will return to the screen in step 3 without deleting the selected documents.

- 5 If you want to delete other stored documents, repeat steps 3 and 4.

- 6 Touch the “Close” key. The touch panel will return to the screen in step 2.

Touch the “End” key. The touch panel will return to the contents of the “Basic” tab.

(4) Synergy print boxes

① Storing documents in a box

Perform the following procedure when you want to register a set of documents in a synergy print box.

- 1** Set the documents to be stored.
- 2** Press the [Document Management] key. The “Document Management” screen will be displayed.

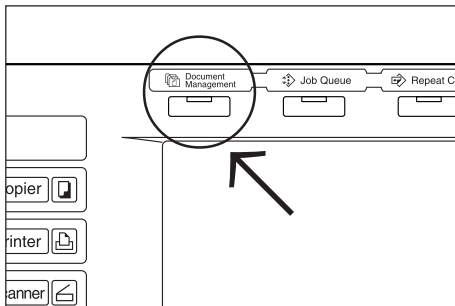

- 3** Touch the “Document reg.” [“Document registr.”] key under “Synergy Print Box”. The screen to select the synergy print box will be displayed.

Inch specifications

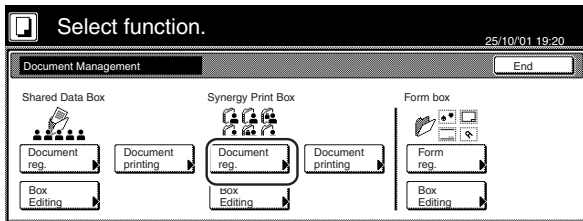

Metric specifications

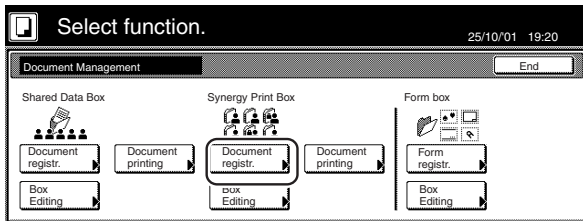

- 4** Either touch the synergy print box in which you want to register the documents, or enter its number using the keypad. Then touch the “Enter” key. The “Document registration” screen will be displayed.

Inch specifications

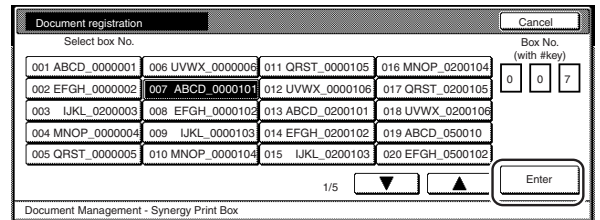

Metric specifications

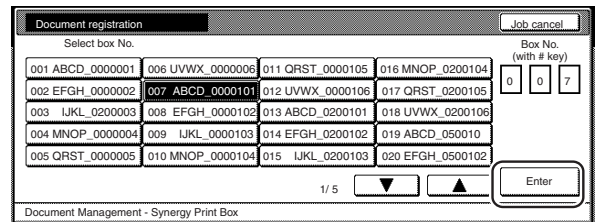

- 5** Touch the “Change name” key and then enter a name for the documents.

If you do not want to register a name for the documents, go directly to the next step.

Inch specifications

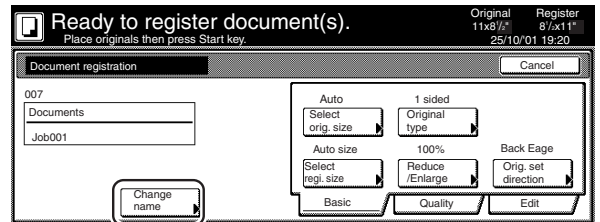

Metric specifications

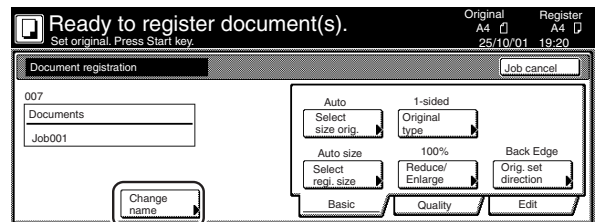

NOTE

Refer to “11. Entering characters” on page 7-104 for information on entering characters.

Section 6 DOCUMENT AND OUTPUT MANAGEMENT FUNCTIONS

- 6** Touch the “Select orig. size” [“Select size orig.”] key, the “Select regi. size” key, the “Original type” key, the “Reduce/Enlarge” key and/or the “Orig.set direction” key, if you want to perform the corresponding settings.

If you want to access the “Scanning density” key and/or the “Orig.image quality” [“Image quality”] key to make those settings, touch the “Quality” key.

If you want to set access the “Border Erase” [“Erase Mode”] key and/or the “Continuous scanning” [“Multiple scanning”] key to make those settings, touch the “Edit” key.

- 7** Press the [Start] key. Scanning of the documents will start. Once all of the documents have been completely scanned, the touch panel will return to the screen in step 3.

If you want to register another document, repeat steps 3 through 7.

- 8** Touch the “End” key. The touch panel will return to the contents of the “Basic” tab.

② Combining and printing out stored documents

Perform the following procedure when you want to combine and print out documents that are stored in a synergy print box.

- 1** Press the [Document Management] key. The “Document Management” screen will be displayed.

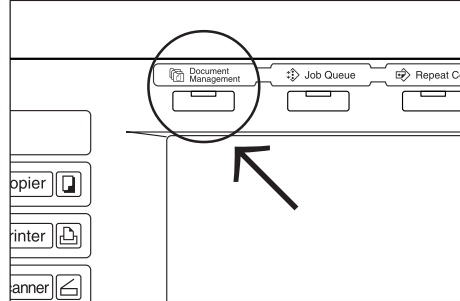

- 2** Touch the “Document printing” key under “Synergy Print Box”. The screen to select the synergy print box will be displayed.

Inch specifications

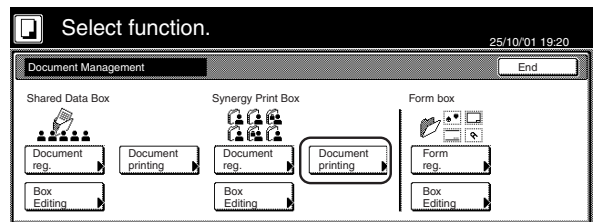

Metric specifications

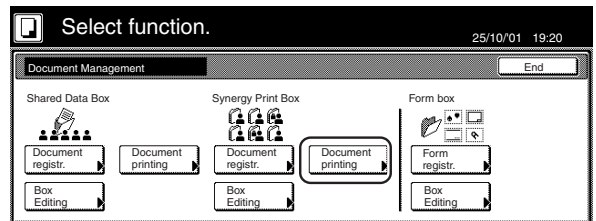

- 3 Either touch the synergy print box that contains the documents to be printed out, or enter its number using the keypad. Then touch the “Enter” key. The “Document printing” screen will be displayed.

Inch specifications

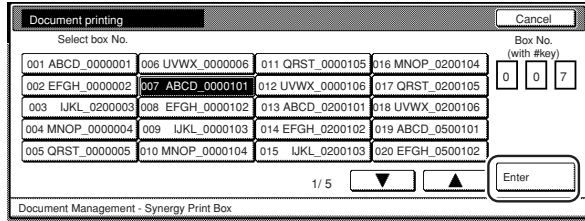

Metric specifications

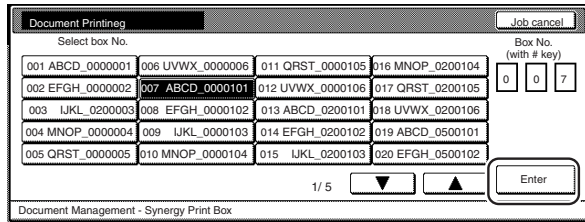

NOTES

- If that box was registered with a password, the password entry screen will be displayed. Enter the registered password with the keypad and then touch the “Enter” key.

Inch specifications

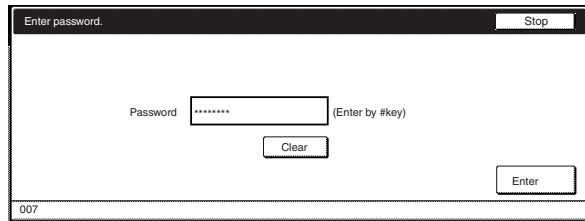

Metric specifications

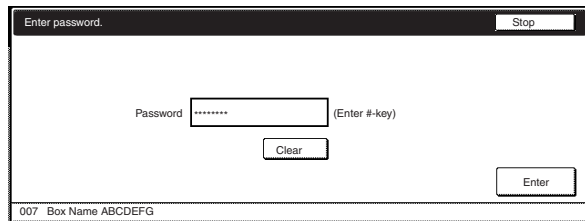

- Refer to “⑦ Registering a password for a box” on page 6-18 for information on registering the password.

- 4 Select the document sets in order of how you want them printed. Up to 10 sets of documents can be selected.

Inch specifications

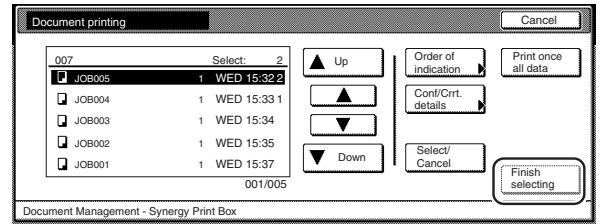

Metric specifications

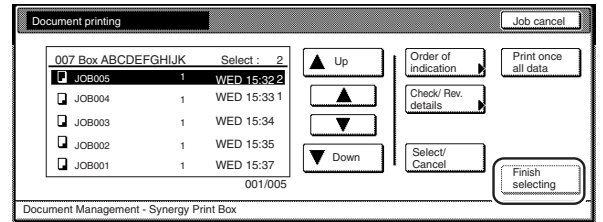

NOTES

- It is possible to change the order of display for the stored documents. To do so, touch the “Order of indication” key, and then touch the “Sort by date” key (and select either “New → Old” or “Old → New”) or the “Sort by name” key (and select either “A → Z” or “Z → A”), as appropriate.
- If you want to print out more than one set of documents, they must all be of the same size.

- 5 Touch the “Select paper” key, the “Sort/Finished” key and/or the “1 sided/ 2 sided” key, to perform the corresponding settings. If you want to access the “Form Overlay” key, the “Margin” key, the “Cover Mode” key, the “Page #” key, the “Booklet” key and/or the “Select of Output” key to make those settings, touch the “Edit” key.

- 6 Press the [Start] key. Print out will start.

Section 6 DOCUMENT AND OUTPUT MANAGEMENT FUNCTIONS

③ Printing out the full contents of a box

Perform the following procedure when you want to print out all of the documents that are stored in a synergy print box at one time.

- 1 Press the [Document Management] key. The “Document Management” screen will be displayed.

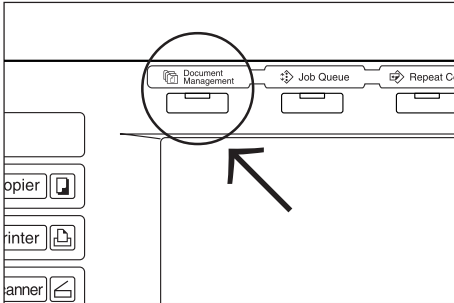

- 2 Touch the “Document printing” key under “Synergy Print Box”. The screen to select the synergy print box will be displayed.

Inch specifications

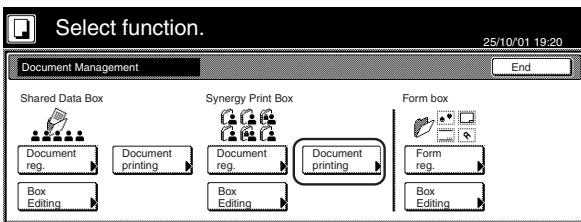

Metric specifications

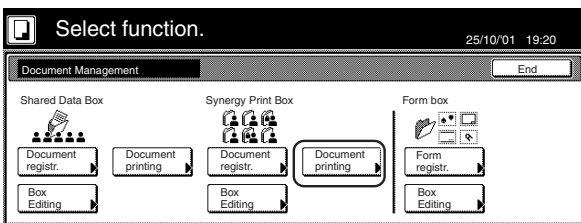

- 3 Either touch the synergy print box that contains the documents to be printed out, or enter its number using the keypad. Then touch the “Enter” key. The “Document printing” screen will be displayed.

Inch specifications

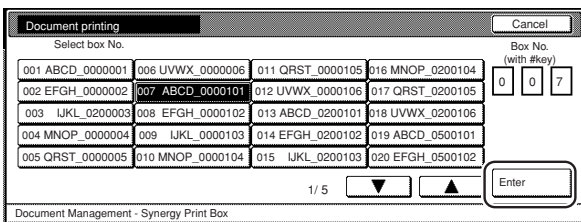

Metric specifications

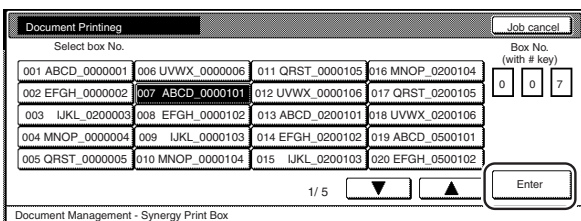

NOTES

- If that box was registered with a password, the password entry screen will be displayed. Enter the registered password with the keypad and then touch the “Enter” key.

Inch specifications

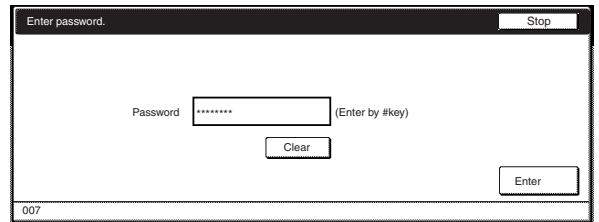

Metric specifications

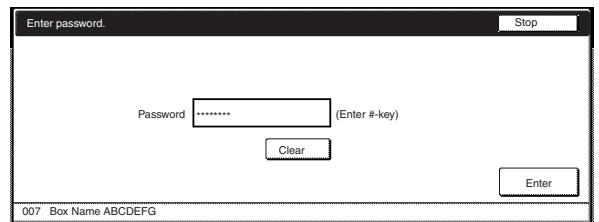

- Refer to “⑦ Registering a password for a box” on page 6-18 for information on registering the password.

- 4 Touch the “Print once all data” key. Print out will start. Once printing is completed, the touch panel will return to the screen in step 2.

Inch specifications

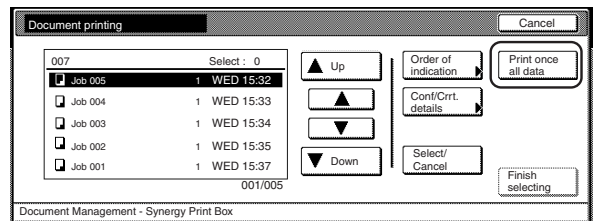

Metric specifications

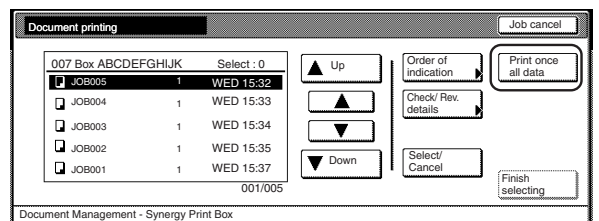

- 5 Touch the “End” key. The touch panel will return to the contents of the “Basic” tab.

④ Checking stored documents and changing their names

Perform the following procedure when you want to verify the name of stored documents, the size of the original documents or the date and time they were stored in the synergy print box, or when you want to print out the first page of those document in order to check them. You can also use this procedure to change the registered name for the documents.

1 Press the [Document Management] key. The “Document Management” screen will be displayed.

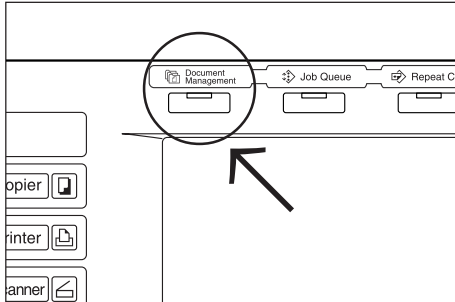

2 Touch the “Document printing” key or the “Box Editing” key under “Synergy Print Box”. The screen to select the synergy print box will be displayed.

Inch specifications

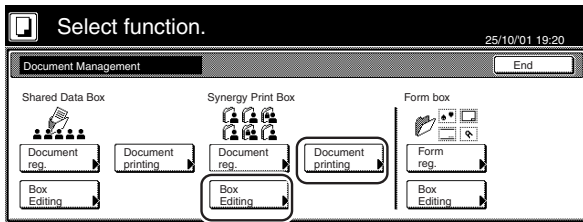

Metric specifications

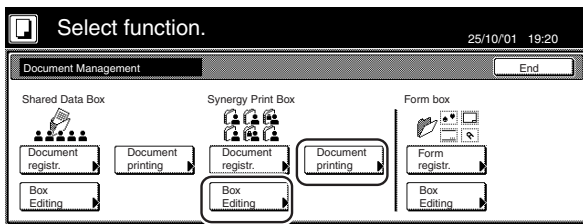

3 Either touch the synergy print box that contains the documents to be printed out, or enter its number using the keypad. Then touch the “Enter” key. The “Document printing” screen or the “Box editing” screen, as appropriate, will be displayed.

Inch specifications

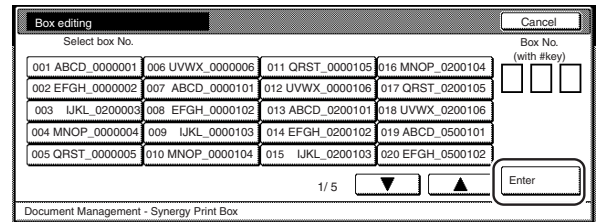

Metric specifications

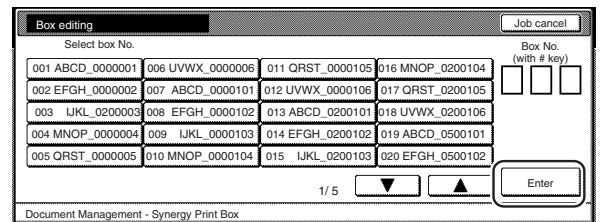

NOTES

- If that box was registered with a password, the password entry screen will be displayed. Enter the registered password with the keypad and then touch the “Enter” key.

Inch specifications

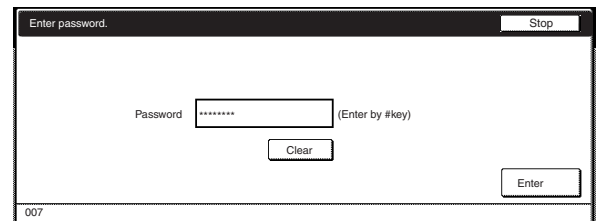

Metric specifications

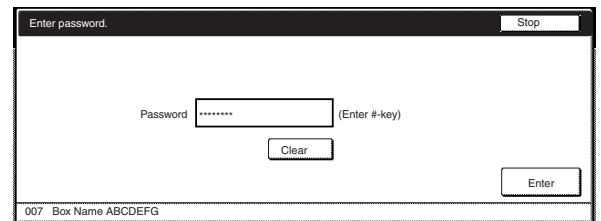

- Refer to “⑦ Registering a password for a box” on page 6-18 for information on registering the password.

Section 6 DOCUMENT AND OUTPUT MANAGEMENT FUNCTIONS

- 4** Select the documents that you want to check and then touch the “Conf/Correct details” [“Check/Rev. details”] key. The “Check/Correct details” [“Check/revise details”] screen will be displayed.

Inch specifications

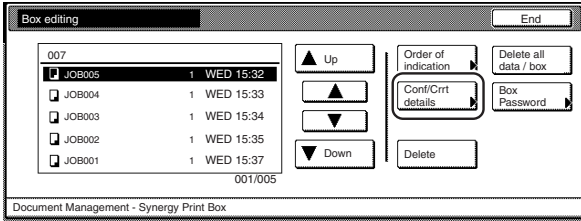

Metric specifications

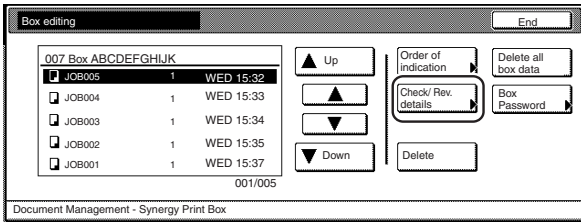

NOTE

Refer to “11. Entering characters” on page 7-104 for information on entering characters.

- 6** Once you have finished checking the information for those documents, touch the “Close” key. The touch panel will return to the screen in step 4.

If you want to check the information for other stored documents, repeat steps 4 through 6.

- 7** Touch the “End” key. The touch panel will return to the screen in step 2.

Touch the “End” key. The touch panel will return to the contents of the “Basic” tab.

NOTE

It is possible to change the order of display for the stored documents. To do so, touch the “Order of indication” key, and then touch the “Sort by date” key (and select either “New → Old” or “Old → New”) or the “Sort by name” key (and select either “A → Z” or “Z → A”), as appropriate.

- 5** Check the displayed information. If you want to print out the first page of the selected documents, touch the “Print from 1st” [“Head print”] key. If you want to change the name of the selected documents, touch the “Change doc.name” key and then enter the new name.

Inch specifications

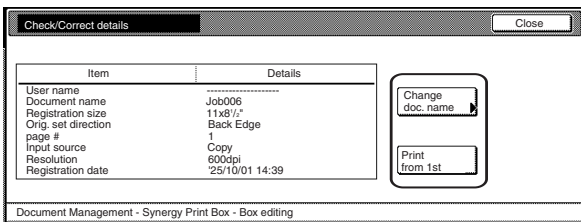

Metric specifications

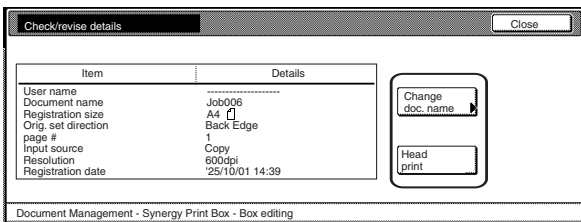

⑤ Deleting stored documents from a box

Perform the following procedure when you want to delete stored documents.

- 1 Press the [Document Management] key. The “Document Management” screen will be displayed.

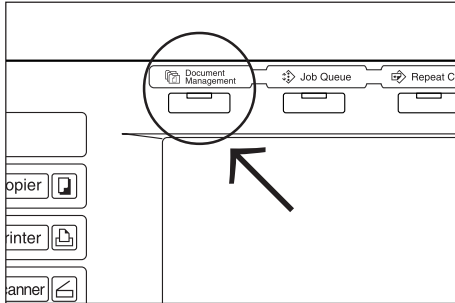

- 2 Touch the “Box Editing” key under “Synergy Print Box”. The screen to select the synergy print box will be displayed.

Inch specifications

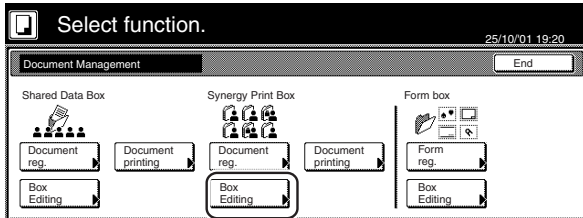

Metric specifications

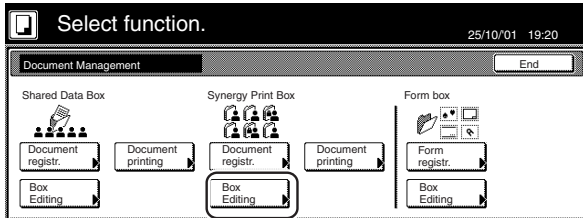

- 3 Either touch the synergy print box that contains the documents to be deleted, or enter its number using the keypad. Then touch the “Enter” key. The “Box editing” screen will be displayed.

Inch specifications

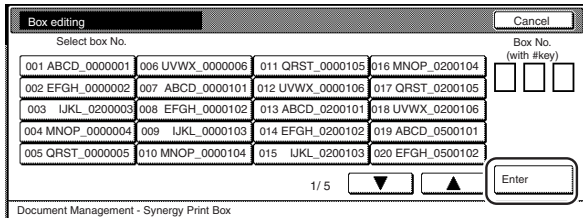

Metric specifications

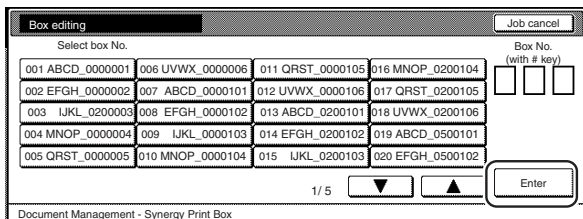

NOTES

- If that box was registered with a password, the password entry screen will be displayed. Enter the registered password with the keypad and then touch the “Enter” key.

Inch specifications

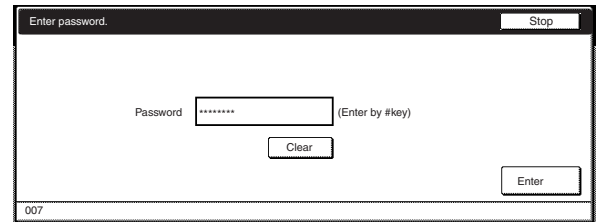

Metric specifications

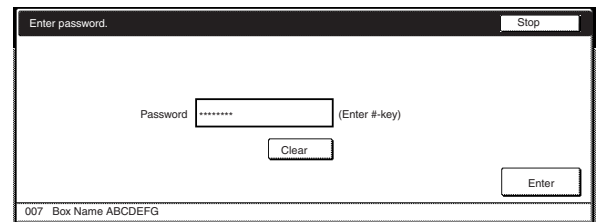

- Refer to “⑦ Registering a password for a box” on page 6-18 for information on registering the password.

- 4 Select the documents that you want to delete and then touch the “Delete” key. A verification screen will be displayed.

Inch specifications

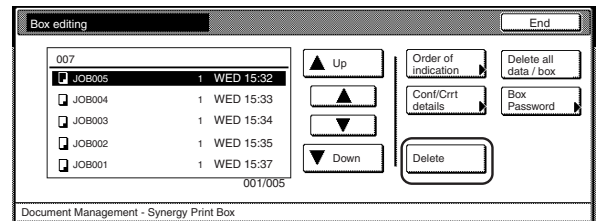

Metric specifications

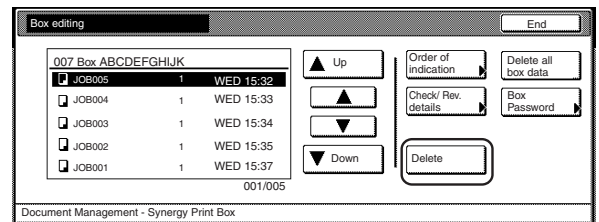

NOTE

It is possible to change the order of display for the stored documents. To do so, touch the “Order of indication” key, and then touch the “Sort by date” key (and select either “New → Old” or “Old → New”) or the “Sort by name” key (and select either “A → Z” or “Z → A”), as appropriate.

Section 6 DOCUMENT AND OUTPUT MANAGEMENT FUNCTIONS

- 5** Touch the “Yes” key or the “No” key, as appropriate.

Inch specifications

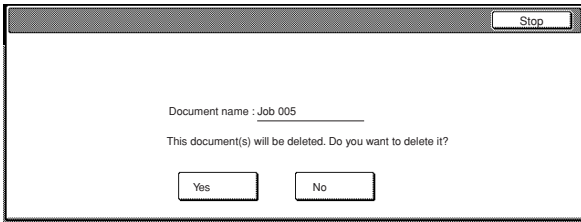

Metric specifications

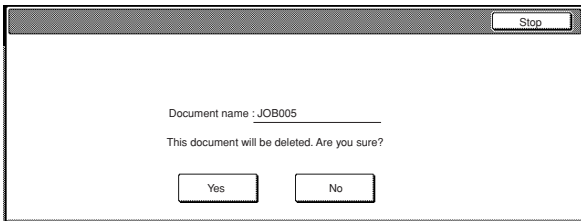

If you selected “Yes”, the selected documents will be deleted and the touch panel will return to the screen in step 4.
If you selected “No”, the touch panel will return to the screen in step 4 without deleting the selected documents.

- 6** If you want to delete other stored documents, repeat steps 4 and 5.

- 7** Touch the “End” key. The touch panel will return to the screen in step 2.

Touch the “End” key once again. The touch panel will return to the contents of the “Basic” tab.

- ⑥ Deleting the full contents of a box**

Perform the following procedure when you want to delete the full contents of a synergy print box in one step.

- 1** Press the [Document Management] key. The “Document Management” screen will be displayed.

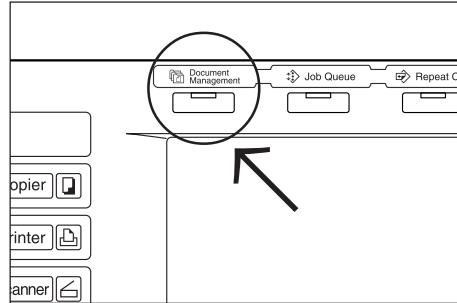

- 2** Touch the “Box editing” key under “Synergy Print Box”. The screen to select the synergy print box will be displayed.

Inch specifications

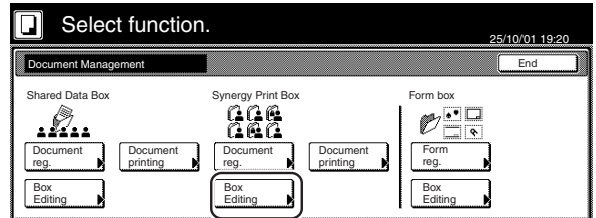

Metric specifications

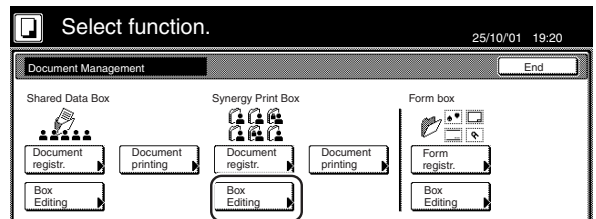

- 3** Either touch the synergy print box that contains the documents to be deleted, or enter its number using the keypad. Then touch the “Enter” key. The “Box editing” screen will be displayed.

Inch specifications

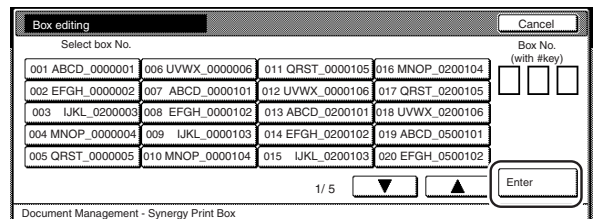

Metric specifications

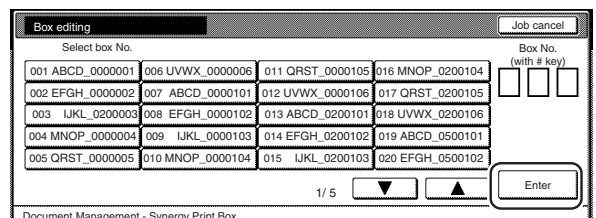

NOTES

- If that box was registered with a password, the password entry screen will be displayed.
Enter the registered password with the keypad and then touch the “Enter” key.

Inch specifications

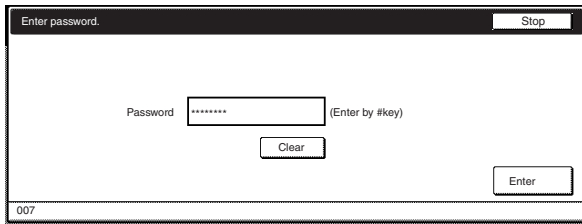

Metric specifications

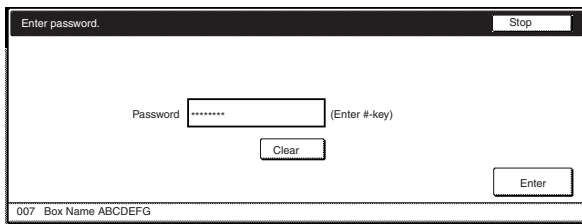

- Refer to “⑦ Registering a password for a box” on page 6-18 for information on registering the password.

- 4** Touch the “Delete all data / box” [“Delete all box data”] key. A verification screen will be displayed.

Inch specifications

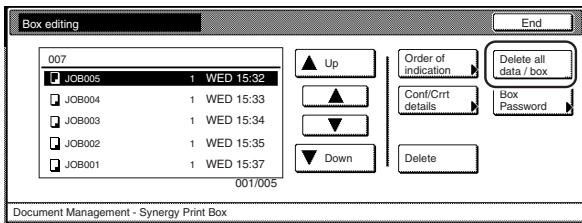

Metric specifications

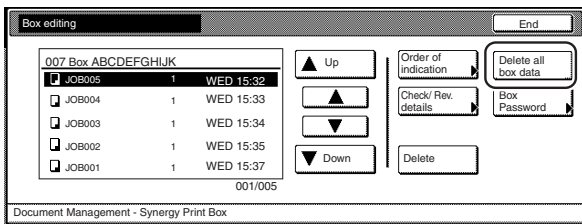

- 5** Touch the “Yes” key or the “No” key, as appropriate.

Inch specifications

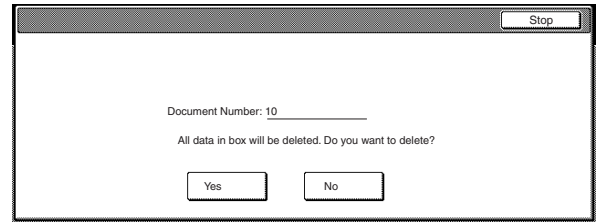

Metric specifications

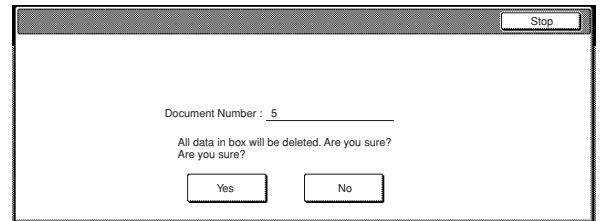

If you selected “Yes”, the entire contents of the selected box will be deleted and the touch panel will return to the screen in step 4.

If you selected “No”, the touch panel will return to the screen in step 4 without deleting any documents.

- 6** Touch the “End” key. The touch panel will return to the screen in step 2.

Touch the “End” key once again. The touch panel will return to the contents of the “Basic” tab.

Section 6 DOCUMENT AND OUTPUT MANAGEMENT FUNCTIONS

⑦ Registering a password for a box

For security and privacy purposes, you can register a password for each synergy print box. In this case, it will be necessary to enter the registered password in order to print out, check or delete any documents stored in that box. Perform the following procedure when you want to change the password settings for any box.

- 1 Press the [Document Management] key. The "Document Management" screen will be displayed.

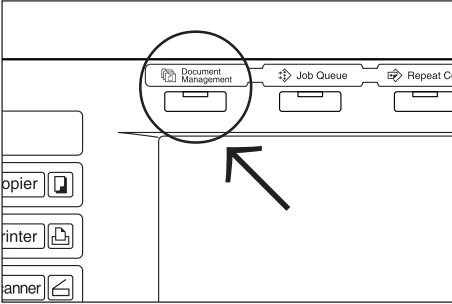

- 2 Touch the "Box Editing" key under "Synergy Print Box". The screen to select the synergy print box will be displayed.

Inch specifications

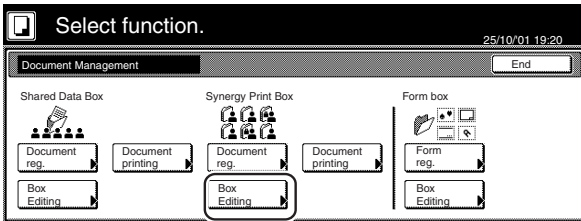

Metric specifications

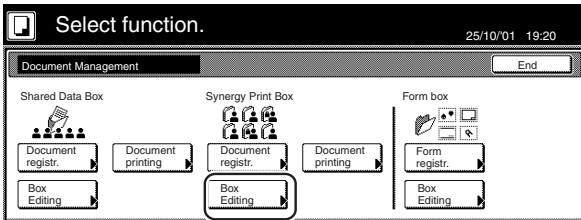

- 3 Either touch the synergy print box that you want to set the password for, or enter its number using the keypad. Then touch the "Enter" key. The "Box editing" screen will be displayed.

Inch specifications

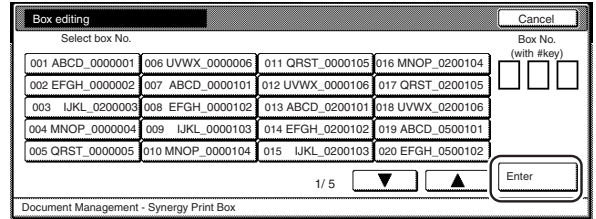

Metric specifications

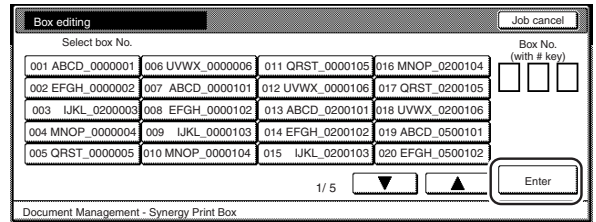

NOTE

If that box was registered with a password, the password entry screen will be displayed.

Enter the registered password with the keypad and then touch the "Enter" key.

Inch specifications

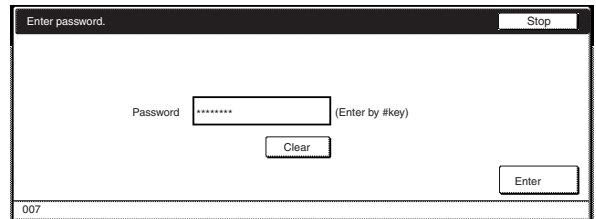

Metric specifications

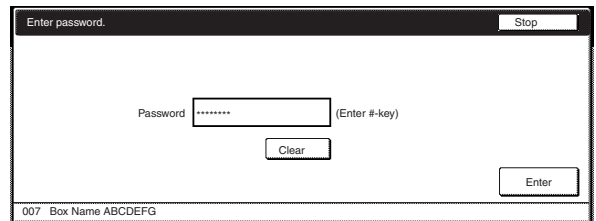

- 4 Touch the “Box Password” key. A verification screen will be displayed.

Inch specifications

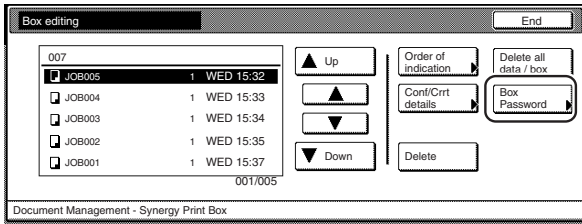

Metric specifications

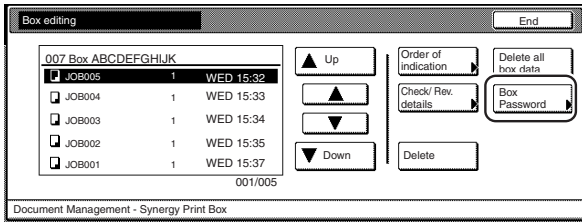

- 5 Use the keypad to enter the new password for that box and then touch the “Enter” key. The new password will be registered and the touch panel will return to the screen in step 4.

Inch specifications

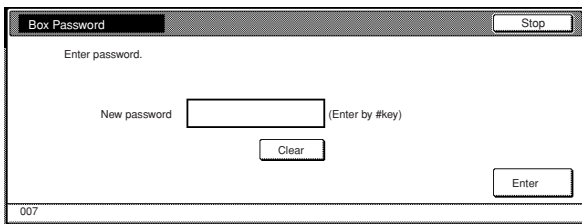

Metric specifications

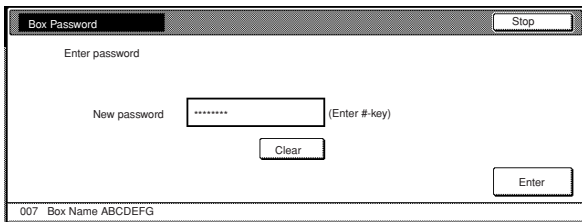

NOTES



- The password can be between 1 and 8 digits long.
- If you decide not to register a password for that box, touch the “Clear” key and then, with nothing entered in the password field, touch the “Enter” key.

- 6 Touch the “End” key. The touch panel will return to the screen in step 2.
Touch the “End” key. The touch panel will return to the contents of the “Basic” tab.

2. Output management functions

(1) What are the “output management” functions?

The “Output management” functions use the “Print status” screen to manage printing conditions.

| Objective | Procedure |
|---|---|
| When you want to know how many jobs are scheduled to be printed before yours. | You can verify the documents that are waiting to be printed by checking the “Print status” screen. The jobs in the list are printed in order from the top down, so you can easily see in which order your documents will be printed. * The optional Hard Disk must be installed on this copier in order to perform this operation. |
| When you want to know whether or not your job (scheduled using the job reservation function) was printed. | Check the “Print status” screen. If your job IS in the “Print status” screen, that job has not yet been printed. * The optional Hard Disk must be installed on this copier in order to perform this operation. |
| When you are using the printer functions of this copier to print out data from a computer, or using the fax functions of this copier to receive fax data, and you want know the status of your print job. | With the “output management functions”, jobs using the printer functions of this copier to print out data from a computer or using the fax functions of this copier to receive fax data are displayed just like any other copy job. These print jobs can be verified just like copy jobs by checking the “Print status” screen. (A “  ” icon under the “Job” heading indicates a copy job, a “  ” icon indicates a print job, and a “  ” icon indicates a fax job.) |
| When you want to check the contents of a copy job that is waiting to be printed. | The number of originals, number of copies to be made, the date the job was scheduled, and the status of printing can all be verified in the “Print status” screen. In addition, if you need even more detailed information on any particular job, just select that job and touch the “Conf/Crrt. details” [“Check/ Correct details”] key to display the e size of the paper the job will be output to and, if it has been designated, the location of ejection of the finished copies. * The optional Hard Disk must be installed on this copier in order to perform this operation. |
| When you want to force-print a copy job that is waiting to be printed immediately. | <p>Select the job that you want to print immediately in the “Print status” screen and touch the “Move ahead” [“Move up”] key to move that job upwards to the top of the list. * It is only possible to change the printing order for copy jobs. It is not possible to move copy jobs ahead of print and fax jobs. * The optional Hard Disk must be installed on this copier in order to perform this operation.</p> <p>OR, select the job that you want to print immediately in the “Print status” screen and touch the “Interrupt print” key to stop the job that is currently being printed and start print out for the selected job. * The optional Hard Disk must be installed on this copier in order to force-print a copy job.</p> |
| When you want to cancel a copy job that is waiting to be printed. | Select the job that you want to cancel in the “Print status” screen and touch the “Cancel/Delete” key. The selected job will be canceled. * The optional Hard Disk must be installed on this copier in order to perform this operation. |

Section 6 DOCUMENT AND OUTPUT MANAGEMENT FUNCTIONS

The following operations can be managed.

- When the optional Hard Disk is NOT installed

| | Check print status | Change the print order | Interrupt printing (force-print) | Cancel / Delete | Check job contents |
|------------------|--------------------|------------------------|----------------------------------|-----------------|--------------------|
| Copy job | × | × | × | × | × |
| Print or Fax job | ○ | × | ○ | × | × |

- When the optional Hard Disk IS installed

| | Check print status | Change the print order | Interrupt printing (force-print) | Cancel / Delete | Check job contents |
|------------------|--------------------|------------------------|----------------------------------|-----------------|--------------------|
| Copy job | ○ | ○ *1 | ○ | ○ | ○ |
| Print or Fax job | ○ | × | ○ | × | × |

*1 Print or fax jobs will automatically be moved to a position immediately after the job currently being printed. It is not possible to move copy jobs ahead of print and fax jobs.

(2) Display of the output management functions

Press the [Job Queue] key. The "Print status" screen will be displayed.

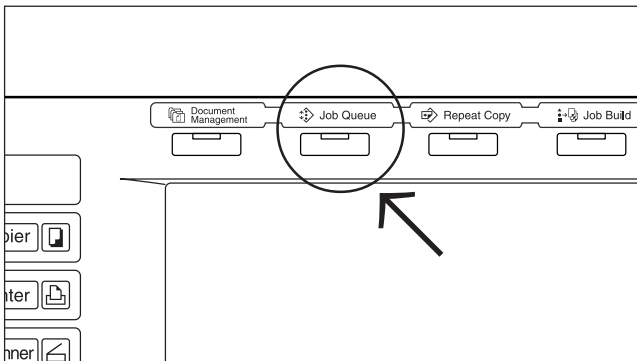

Inch specifications

| Job | Input source | Original | Set | Registration | State |
|-----|--------------|----------|-----|--------------|----------|
| 123 | Copy | 100 | 100 | 10/10 23:00 | Printing |
| 124 | Printer | --- | --- | --- | Waiting |
| 127 | Fax | --- | --- | --- | Waiting |
| 128 | Copy | 1 | 5 | 10/10 23:00 | Waiting |

Buttons: Move ahead, Move behind, interrupt print, Cancel/Delete, Cont./Crrt. details

Print status 10/10 23:50

Metric specifications

| Job | Input source | Original | Set | Registration | State |
|-----|--------------|----------|-----|--------------|----------|
| 123 | Copy | 100 | 100 | 10/10 23:00 | Printing |
| 124 | Printer | --- | --- | --- | Waiting |
| 127 | Fax | --- | --- | --- | Waiting |
| 128 | Copy | 1 | 5 | 10/10 23:00 | Waiting |

Buttons: Move up, Move down, interrupt print, Cancel/Delete, Check/Rev. details

Print status 10/10 23:50

Section 6 DOCUMENT AND OUTPUT MANAGEMENT FUNCTIONS

(3) The “Print status” screen

This screen displays the currently set printing conditions and the job queue of documents waiting to be printed.

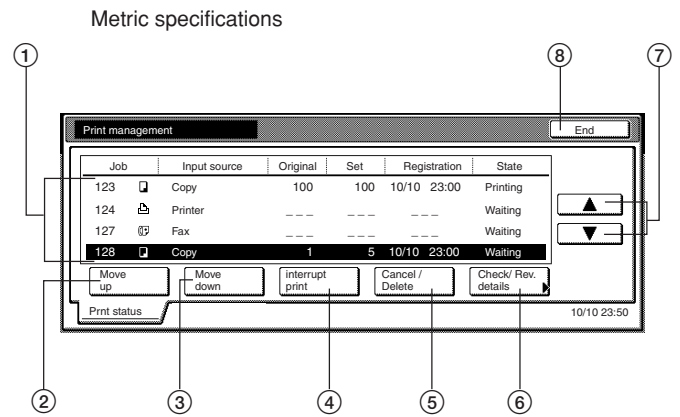
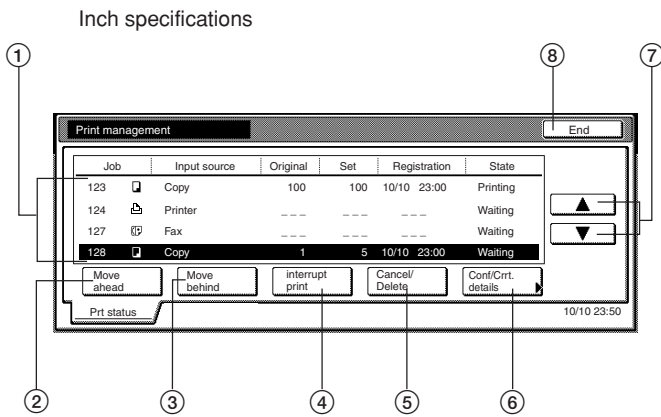

① Job queue

Displays information about each job in the queue.

The job at the top of the list is that job that is currently being printed. The rest of the jobs will be printed in order from the top down.

A “” icon under the “Job” heading indicates a copy job, a “” icon indicates a print job, and a “” icon indicates a fax job.

② “Move ahead” key

Touching this key moves the currently selected (highlighted) job upward in the job queue. A job can be moved as far as the second highest position in the list. In this case, print out for that job will begin as soon as the current job is completed. (This is only available when the optional Hard Disk is installed on this copier.)

③ “Move behind” [“Move down”] key

Touching this key moves the currently selected (highlighted) job downward in the job queue. (This is only available when the optional Hard Disk is installed on this copier.)

④ “Interrupt print” key

Touching this key interrupts the job that is currently being printed and start print out for the currently selected (highlighted) job. (The selected job will be moved to the top of the list.)

⑤ “Cancel/Delete” key

Touching this key cancels the currently selected (highlighted) job and deletes it from the job queue. (This is only available when the optional Hard Disk is installed on this copier.)

⑥ “Conf/Crrt.details” [“Check/Rev. details”] key

Touching this key displays the “Check/Correct details” [“Check/revise details”] screen, enabling you, for example, to check the contents of, or change the number of copies to be made for, the currently selected (highlighted) job. (This is only available when the optional Hard Disk is installed on this copier.)

Inch specifications

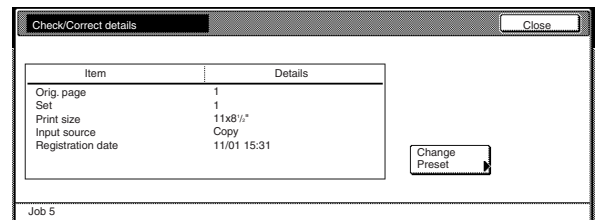

Metric specifications

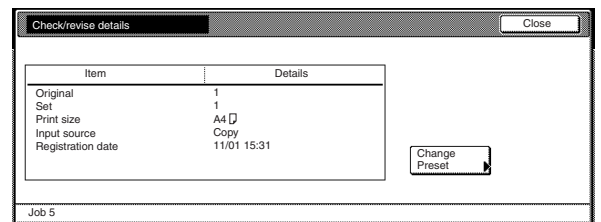

⑦ “▲” and “▼” cursor keys

Use these keys to select a job from the job queue.

⑧ “End” key

Touching this key quits the output management function. In this case, the touch panel will return to the contents of the “Basic” tab.

Section 7 COPIER MANAGEMENT FUNCTIONS

1. Copy management mode

By registering a different department ID-code for each individual department that uses the copier, the copy management function will help you manage the overall number of copies made by each department.

The copy management function in this copier offers the following features.

- Manage use of all optional functions (printer, scanner and fax) utilized by the same department ID-code.
- Manage up to 100 individual departments. (Up to 1000 when the optional Hard Disk is installed on this copier.)
- Register department ID-codes of up to 8 digits (between 0 and 99999999).
- Check the total number of copies made under all department ID-codes as a whole or by each individual department.
- Set copy limits to any 1-page increment up to 999,999.
- Clear the copy counts for all department ID-codes at one time or for each individual department.
- Check copy counts for your own department without the need to enter the management code. Just enter the corresponding department ID-code.

IMPORTANT!

In order to access the “Change restrictions for use” procedure under “Editing copy management information”, it is necessary to select “On” under “Copier function management ON/OFF”. When the optional Printer Kit, Printer/Scanner Kit or Fax Kit are installed in your copier, it is necessary to select “On” under the corresponding “Printer function management ON/OFF”, “Scanner function management ON/OFF” or “Fax function management ON/OFF” procedure. (See “(6) Changing the copy management default settings” on page 7-25.)

Section 7 COPIER MANAGEMENT FUNCTIONS

(1) Copy management procedures

| Procedure | Description | Reference page |
|---|--|----------------|
| Editing copy management information | <ul style="list-style-type: none"> Register new department ID-codes Perform this procedure when you want to register a new department ID-code and set the restrictions for using the copier under that ID-code. Up to 100 department ID-codes can be registered. (When the optional Hard Disk is installed on this copier, up to 1000 department ID-codes can be registered.) | 7-4 |
| | <ul style="list-style-type: none"> Delete department ID-codes Perform this procedure when you want to delete registered department ID-codes. | 7-16 |
| | <ul style="list-style-type: none"> Change registered information Perform this procedure when you want to change a department name or the corresponding ID-code. | 7-17 |
| | <ul style="list-style-type: none"> Change restrictions for use Perform this procedure when you want to change the restrictions for using the copier under each department ID-code. | 7-20 |
| Checking the copy management counts | <ul style="list-style-type: none"> Check all departments Perform this procedure when you want to check the total number of copies made under all department ID-codes as a whole, print out a copy management report and clear the copy counts for all of the registered department ID-codes. | 7-21 |
| | <ul style="list-style-type: none"> Check individual departments Perform this procedure when you want to check the total number of copies made under each individual department ID-code and/or clear the copy counts for individual departments as well. | 7-23 |
| Turning the copy management function ON/OFF | Perform this procedure and touch the "On" key when you want to turn the copy management function ON, or touch the "Off" key to turn the copy management function OFF. | 7-25 |
| Changing the copy management default settings | Perform this procedure when you want to change the default settings for the copy management function. | 7-25 |

(2) Accessing the copy management menu screen

Perform the following procedure in order to access the copy management menu screen.

- 1 With the content of the “Basic” tab displayed, press the [Default Setting/Counter] key. The “Default setting” screen will be displayed.

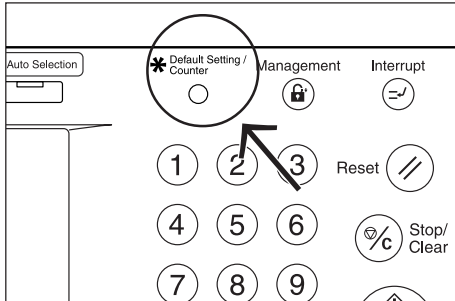

- 2 Touch the “Management” key on the right side of the touch panel.

Inch specifications

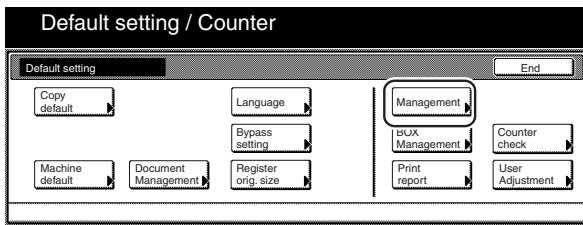

Metric specifications

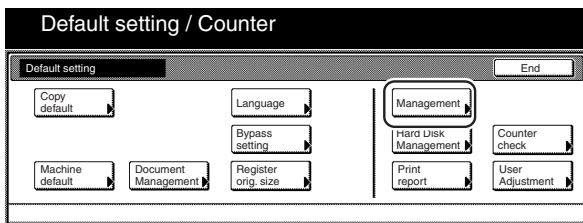

- 3 Use the numeric keys on the keypad to enter the 4-digit management code. The factory default management code for 30 cpm copiers is “3000”, for 40 cpm copiers is “4000” and for 50 cpm copiers is “5000”. If the entered management code matches the currently registered one, the copy management menu screen will be displayed.

Inch specifications

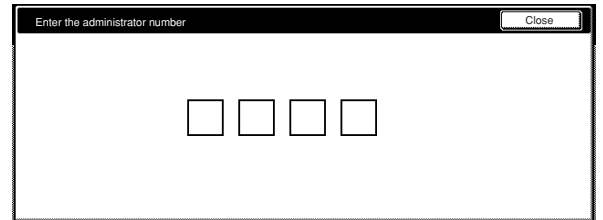

Metric specifications

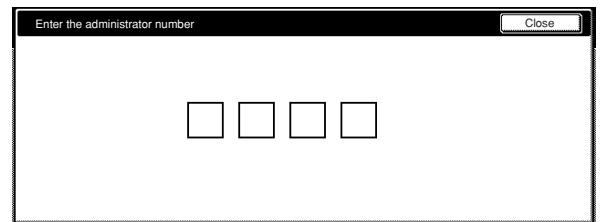

- 4 Touch the key that corresponds to the desired procedure. The setting screen for that procedure will be displayed.

Inch specifications

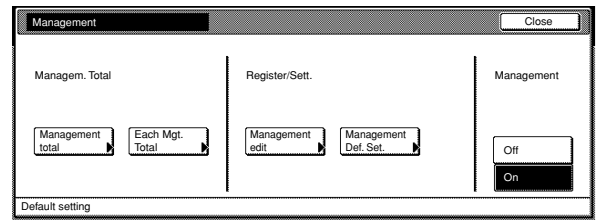

Metric specifications

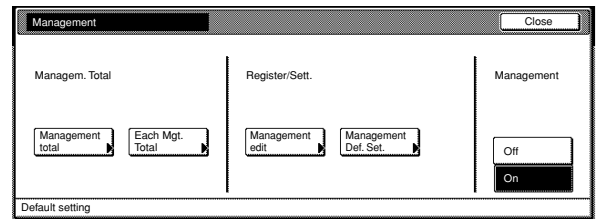

NOTES

- It is possible for you to change the 4-digit management code. (See “Changing the management code” on page 7-56.)
- Perform the following procedure that corresponds to the desired setting.

Section 7 COPIER MANAGEMENT FUNCTIONS

(3) Editing copy management information

● Register new department ID-codes

Perform the following procedure when you want to register department ID-codes (up to 8-digits per ID-code) and the corresponding department name, and set certain restrictions for using the copier under that ID-code.

- 1 Access the copy management menu screen.
(See “Accessing the copy management menu screen”.)

Inch specifications

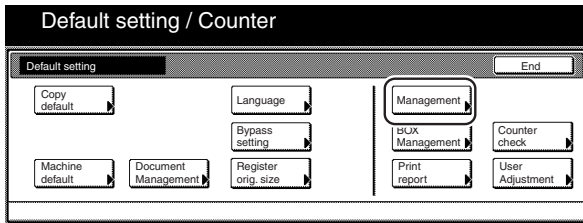

Metric specifications

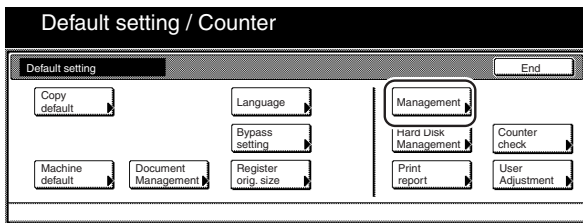

- 2 Touch the “Management edit” key.
The “Management edit” screen will be displayed.

Inch specifications

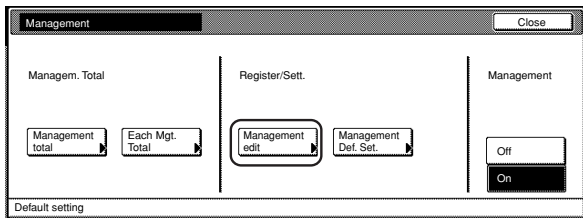

Metric specifications

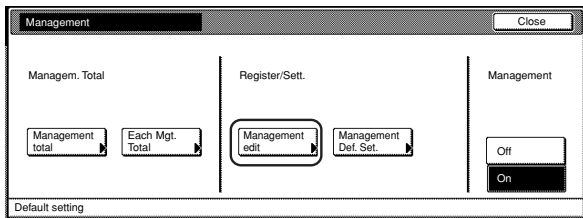

- 3 Touch the “Register” key.
The “New register” screen will be displayed.

Inch specifications

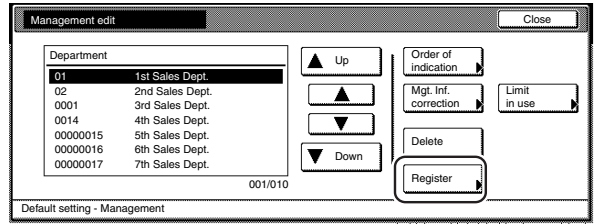

Metric specifications

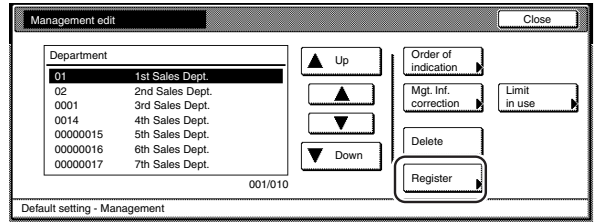

- 4 Select “ID-code” under the “Setting item” column on the left side of the touch panel and then touch the “Change #” key.
The “ID-code” screen will be displayed.

Inch specifications

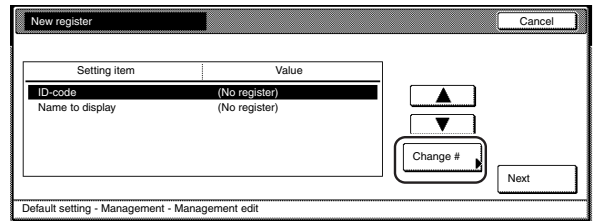

Metric specifications

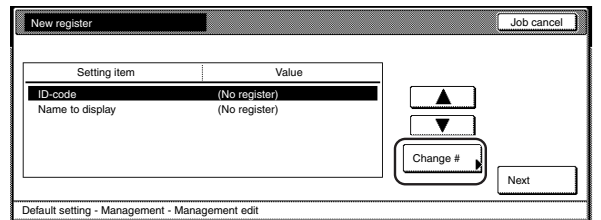

- Use the numeric keys on the keypad to enter the department ID-code that you want to register (up to 8 digits). You can enter any number between "0" and "99999999".

Inch specifications

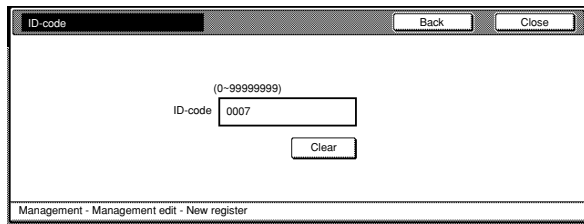

Metric specifications

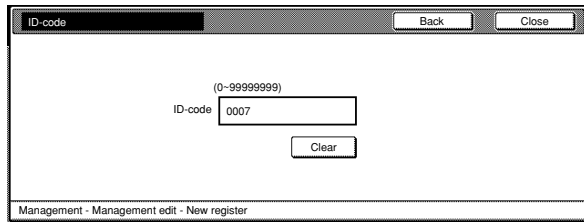

- Touch the "Close" key. The touch panel will return to the screen in step 4.

- Select "Name to display" under the "Setting item" column on the left side of the touch panel and then touch the "Change #" key. The "Name to display" screen will be displayed.

Inch specifications

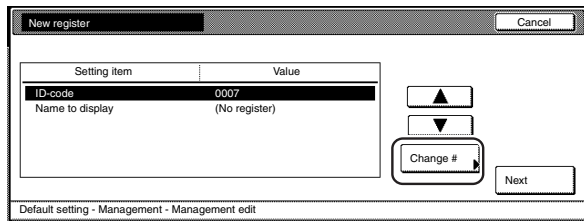

Metric specifications

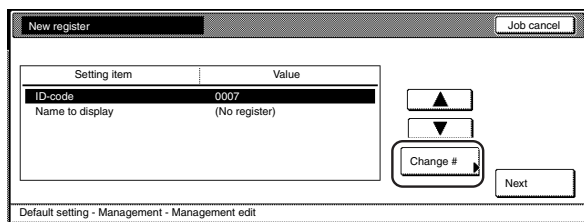

- Enter the name for that department, and then touch the "End" key. The touch panel will return to the screen in step 4.

Inch specifications

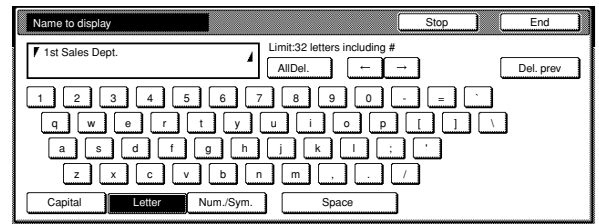

Metric specifications

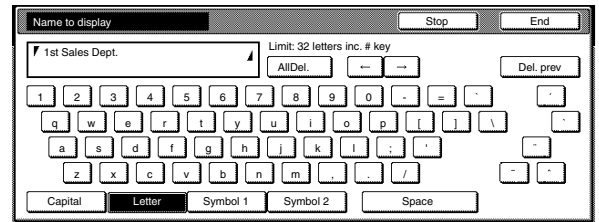

NOTE

For information on how to enter the department name, refer to "11. Entering characters" on page 7-104.

- Once you are finished registering that department's ID-code and name, touch the "Next" key.

Inch specifications

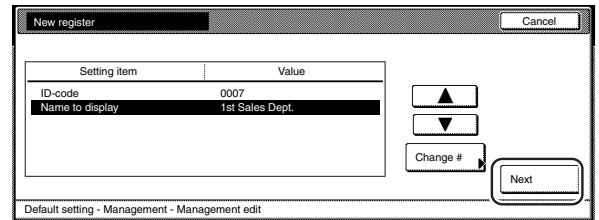

Metric specifications

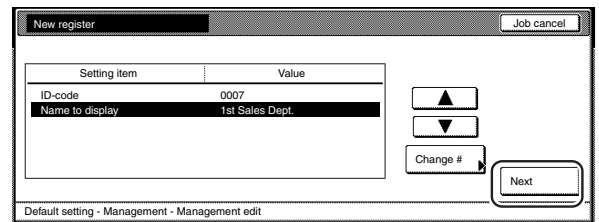

NOTES

- Be sure to register both of the setting items above. If you do not, an error will occur and you will be unable to continue to the next step.
- If you attempt to register a department ID-code or a department name that is already registered, an error will occur and you will be unable to continue to the next step. In this case, select a different ID-code and/or name, as appropriate.

Section 7 COPIER MANAGEMENT FUNCTIONS

- 10** Set the restrictions for using the copier under that department ID-code.

Inch specifications

| Setting item | Value |
|------------------------|----------|
| Copy limitation | On |
| Printer limitation | No limit |
| Output limitation | No limit |
| Scanner limitation | No limit |
| Fax Transm. Limitation | No limit |

Metric specifications

NOTE

For information on how to set restrictions, refer to “Setting the restrictions for use” on page 7-7.

- 12** Touch the “Close” key.
The touch panel will return to the screen in step 2.

Inch specifications

Metric specifications

NOTE

If you want to register an ID-code for a new department, touch the “Register” key and repeat steps 4 through 12.

- 11** Once you are finished setting the restrictions for that department ID-code, touch the “Registr.” key.
The touch panel will return to the screen in step 3.

Inch specifications

Metric specifications

- 13** Touch the “Close” key.

● Setting the restrictions for use

Perform the following procedure when you want to set certain restrictions for using the copier under each department ID-code. The setting items available for restriction will differ depending upon whether you have selected “All” or “Each” as the “Copy/Printer output management” setting. (See “Copy/Printer output management” on page 7-30.) The following settings are available.

If “All” is selected as the “Copy/Printer output management” setting (“All” is the factory default setting)

| | Copier | Printer | Scanning | Fax transmission | Reference page |
|-------------------------------|--------|---------|----------|------------------|----------------|
| Copying privileges ON/OFF | ● | | | | 7-8 |
| Printing privileges ON/OFF | | ● | | | 7-9 |
| Output limitation | △ | △ | | | 7-10 |
| Scanning restrictions | | | ○ | | 7-11 |
| Fax transmission restrictions | | | | ○ | 7-12 |

○: The available settings are “No limit”, “Counter limit” and “Is not permitted”

△: The available settings are “No limit” and “Counter limit”

●: The available settings are “Can use” and “Is not permitted”

If “Each” is selected as the “Copy/Printer output management” setting

| | Copier | Printer | Scanning | Fax transmission | Reference page |
|-------------------------------|--------|---------|----------|------------------|----------------|
| Copying restrictions | ○ | | | | 7-13 |
| Printing restrictions | | ○ | | | 7-14 |
| Scanning restrictions | | | ○ | | 7-11 |
| Fax transmission restrictions | | | | ○ | 7-12 |

○: The available settings are “No limit”, “Counter limit” and “Is not permitted”

Section 7 COPIER MANAGEMENT FUNCTIONS

Copying privileges ON/OFF

Perform the following procedure when you want to turn copying privileges ON or OFF for the corresponding department ID-code.

NOTE

This setting will only be available when "On" is selected as the "Copier function management ON/OFF" setting.

- 1 Access the screen that contains the copy restriction setting items. (See "Register new department ID-codes" on page 7-4 or "Change restrictions for use" on page 7-20.)

Inch specifications

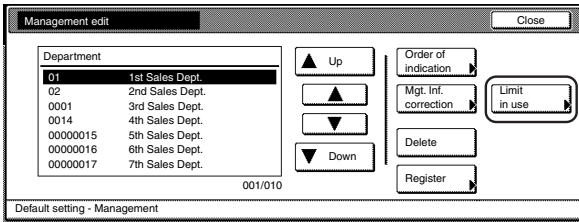

Metric specifications

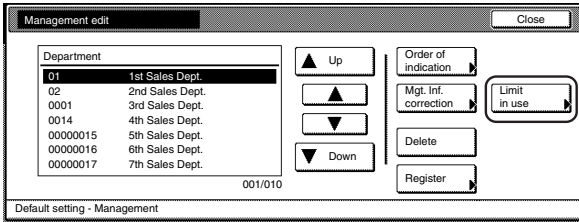

- 2 Select "Copy limitation" under the "Setting item" column on the left side of the touch panel and then touch the "Change #" key.

The "Copy limitation" screen will be displayed.

Inch specifications

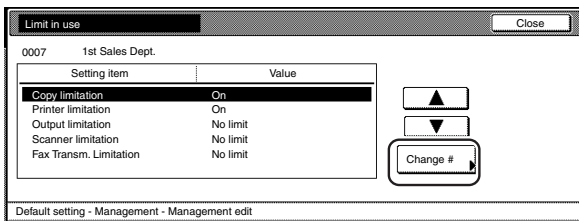

Metric specifications

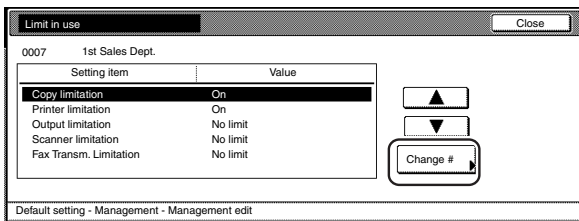

- 3 To allow copying privileges for this ID-code, touch the "Can use" key. To cancel copying privileges completely, touch the "Is not permitted" key.

Inch specifications

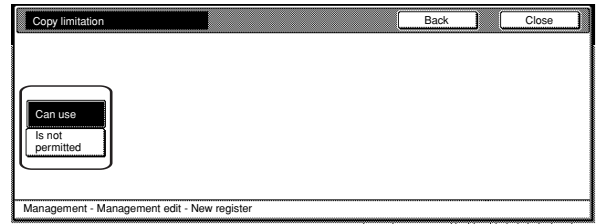

Metric specifications

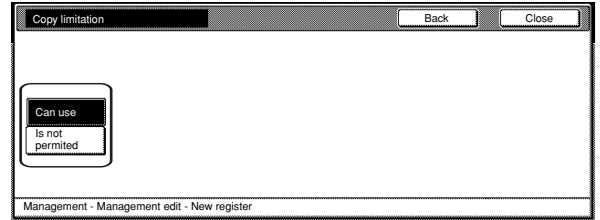

NOTE

If you want to quit the displayed setting without changing it, touch the "Back" key. The touch panel will return to the screen in step 2.

- 4 Touch the "Close" key. The touch panel will return to the screen in step 2.

Printing privileges ON/OFF

Perform the following procedure when the optional Printer Kit or Printer/Scanner Kit is installed in your copier and you want to turn printing privileges ON or OFF for the corresponding department ID-code.

NOTE

This setting will only be available when “On” is selected as the “Printer function management ON/OFF” setting.

1 Access the screen that contains the copy restriction setting items.

(See “Register new department ID-codes” on page 7-4 or “Change restrictions for use” on page 7-20.)

Inch specifications

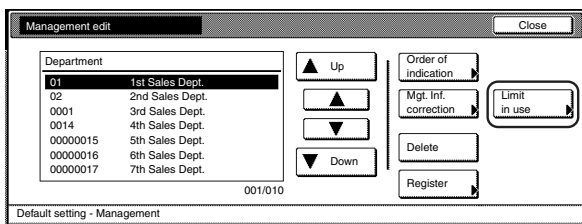

Metric specifications

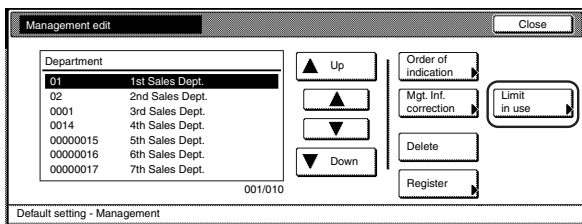

2 Select “Printer limitation” under the “Setting item” column on the left side of the touch panel and then touch the “Change #” key.

The “Printer limitation” screen will be displayed.

Inch specifications

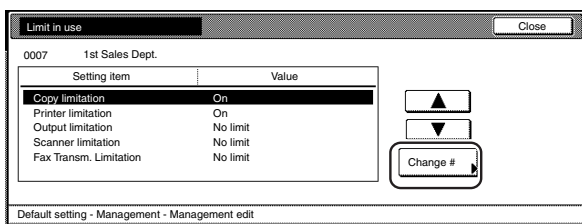

Metric specifications

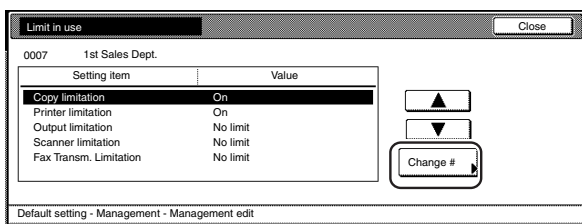

3 To allow printing privileges for this ID-code, touch the “Can use” key. To cancel printing privileges completely, touch the “Is not permitted” key.

Inch specifications

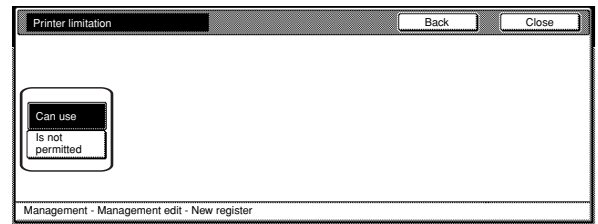

Metric specifications

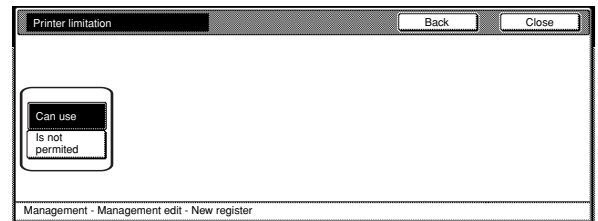

NOTE

If you want to quit the displayed setting without changing it, touch the “Back” key. The touch panel will return to the screen in step 2.

4 Touch the “Close” key. The touch panel will return to the screen in step 2.

Section 7 COPIER MANAGEMENT FUNCTIONS

Output limitation

Perform the following procedure when you want to set the maximum number of copies and printouts that can be made under the corresponding department ID-code. If the optional Printer Kit or Printer/Scanner Kit is installed in your copier, this limit will apply to the number of copies AND printouts that can be made in total.

NOTE

This setting will not be available when "Is not permitted" is selected for both the "Copying privileges ON/OFF" and the "Printing privileges ON/OFF" settings, or when "Is not permitted" is selected as the "Copying privileges ON/OFF" setting and the optional Printer Kit or Printer/Scanner Kit is NOT installed in your copier.

- 1 Access the screen that contains the copy restriction setting items.
(See "Register new department ID-codes" on page 7-4 or "Change restrictions for use" on page 7-20.)

Inch specifications

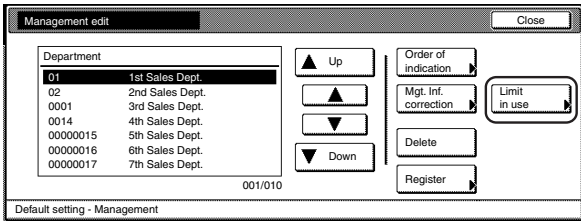

Metric specifications

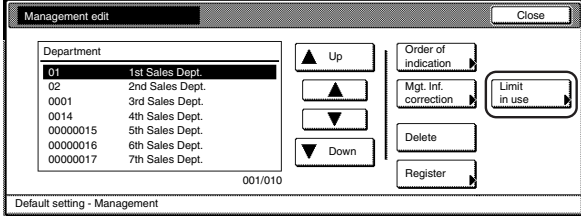

- 2 Select "Output limitation" under the "Setting item" column on the left side of the touch panel and then touch the "Change #" key.

The "Output limitation" screen will be displayed.

Inch specifications

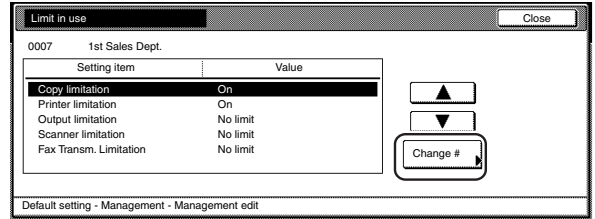

Metric specifications

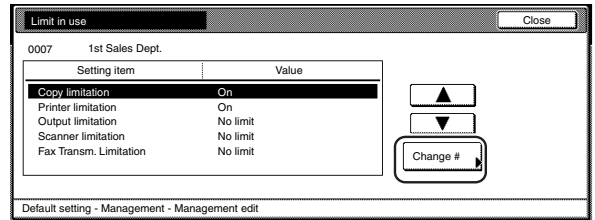

- 3 To set the maximum limit for copying and printing under this ID-code, touch the "Counter limit" key and proceed to the next step.

To allow unlimited copying and printing, touch the "No limit" key and then proceed to step 5.

Inch specifications

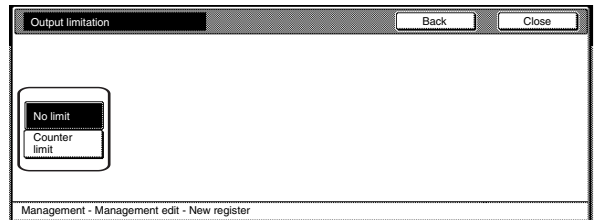

Metric specifications

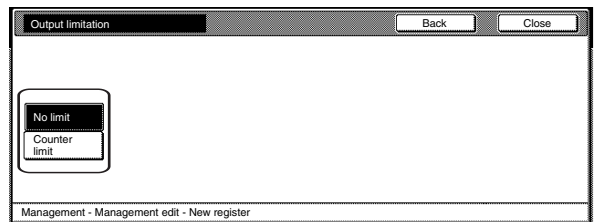

NOTE

If you want to quit the displayed setting without changing it, touch the "Back" key. The touch panel will return to the screen in step 2.

- Use the numeric keys on the keypad to enter the maximum number of copies and printouts that can be made in total under this ID-code. The limit can be set to any 1-page increment up to 999,999.

Inch specifications

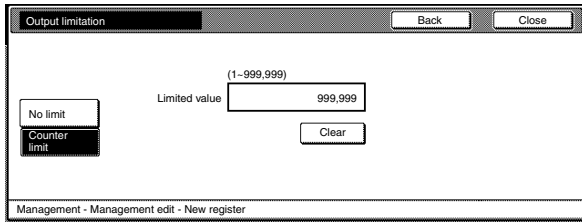

Metric specifications

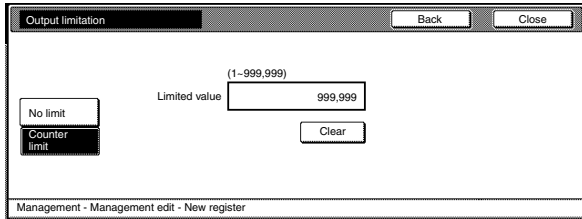

- Touch the "Close" key. The touch panel will return to the screen in step 2.

Scanning restrictions

Perform the following procedure when you want to set the maximum number of originals that can be scanned under the corresponding department ID-code when the optional Printer/Scanner Kit is installed in your copier.

NOTE

This setting will only be available when "On" is selected as the "Scanner function management ON/OFF" setting.

- Access the screen that contains the copy restriction setting items.

(See "Register new department ID-codes" on page 7-4 or "Change restrictions for use" on page 7-20.)

Inch specifications

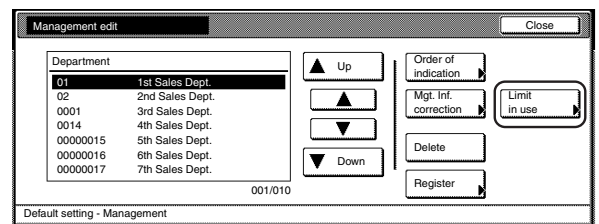

Metric specifications

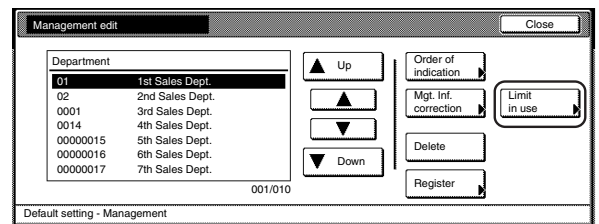

- Select "Scanner limitation" under the "Setting item" column on the left side of the touch panel and then touch the "Change #" key.

The "Scanner limitation" screen will be displayed.

Inch specifications

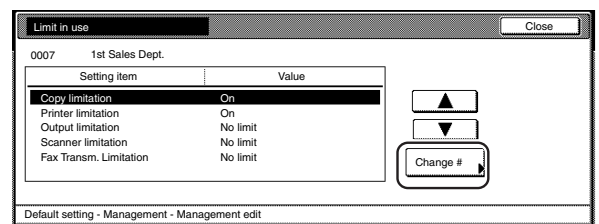

Metric specifications

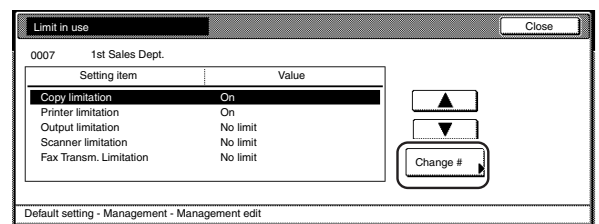

Section 7 COPIER MANAGEMENT FUNCTIONS

- 3** To set the maximum number of originals that can be scanned under this ID-code, touch the “Counter limit” key and proceed to the next step.

To allow unlimited scanning, touch the “No limit” key, and to cancel scanning privileges completely, touch the “Is not permitted” key and proceed to step 5.

Inch specifications

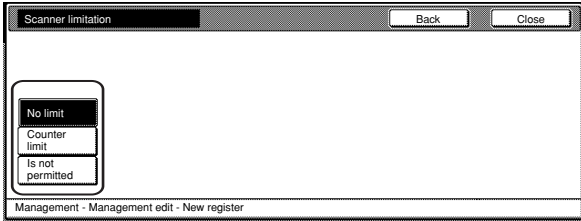

Metric specifications

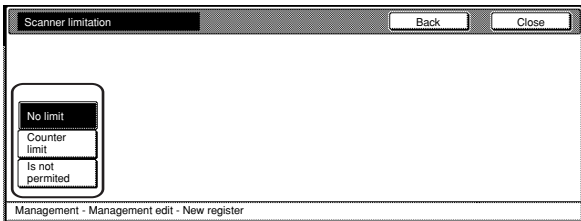

NOTE

If you want to quit the displayed setting without changing it, touch the “Back” key. The touch panel will return to the screen in step 2.

- 4** Use the numeric keys on the keypad to enter the maximum number of originals that can be scanned under this ID-code. The scanning limit can be set to any 1-page increment up to 999,999.

Inch specifications

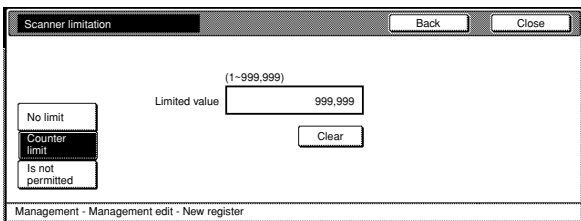

Metric specifications

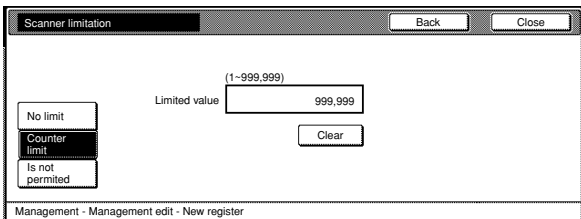

- 5** Touch the “Close” key. The touch panel will return to the screen in step 2.

Fax transmission restrictions

Perform the following procedure when you want to set the maximum number of documents that can be transmitted under the corresponding department ID-code when the optional Fax Kit is installed in your copier.

NOTE

This setting will only be available when “On” is selected as the “Fax function management ON/OFF” setting.

- 1** Access the screen that contains the copy restriction setting items.

(See “Register new department ID-codes” on page 7-4 or “Change restrictions for use” on page 7-20.)

Inch specifications

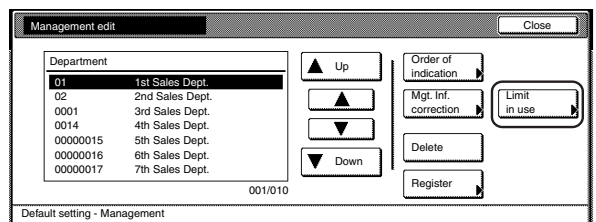

Metric specifications

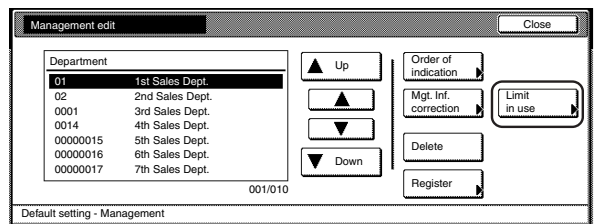

- 2** Select “Fax transm. Limitation” under the “Setting item” column on the left side of the touch panel and then touch the “Change #” key.

The “Fax transm. Limitation” screen will be displayed.

Inch specifications

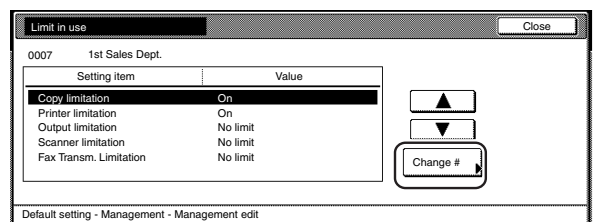

Metric specifications

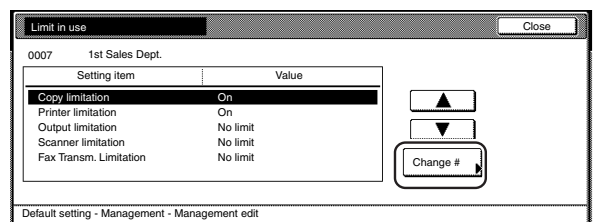

- 3** To set the maximum number of documents that can be transmitted under this ID-code, touch the “Counter limit” key and proceed to the next step.
To allow unlimited fax transmission, touch the “No limit” key, and to cancel fax transmission privileges completely, touch the “Is not permitted” key and proceed to step 5.

Inch specifications

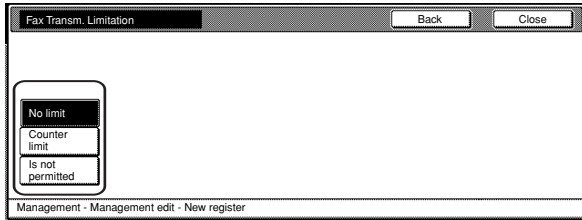

Metric specifications

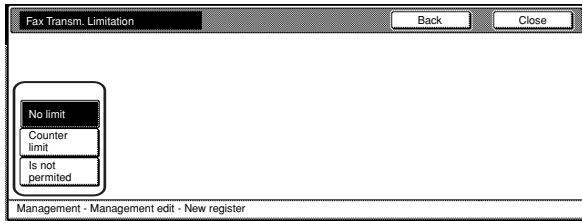

NOTE

If you want to quit the displayed setting without changing it, touch the “Back” key. The touch panel will return to the screen in step 2.

- 4** Use the numeric keys on the keypad to enter the maximum number of documents that can be transmitted under this ID-code. The document limit can be set to any 1-page increment up to 999,999.

Inch specifications

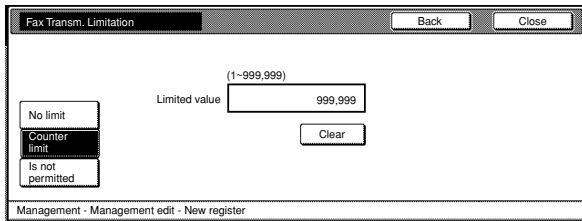

Metric specifications

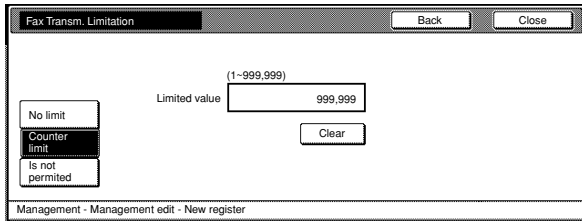

- 5** Touch the “Close” key. The touch panel will return to the screen in step 2.

Copying restrictions

Perform the following procedure when you want to set the maximum number of copies that can be made under the corresponding department ID-code.

NOTES

- This setting will only be available when “On” is selected as the “Copier function management ON/OFF” setting.

- 1** Access the screen that contains the copy restriction setting items.
(See “Register new department ID-codes” on page 7-4 or “Change restrictions for use” on page 7-20.)

Inch specifications

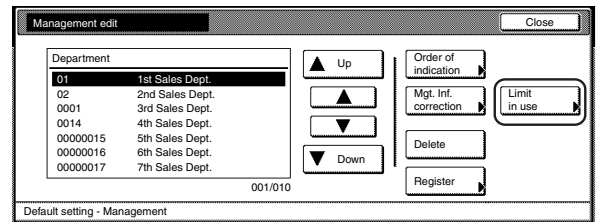

Metric specifications

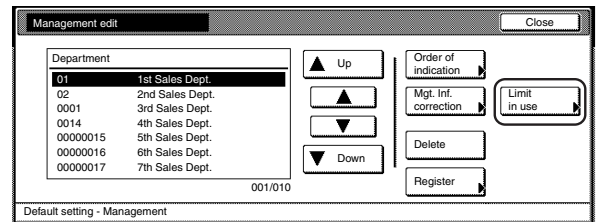

- 2** Select “Copy limitation” under the “Setting item” column on the left side of the touch panel and then touch the “Change #” key.
The “Copy limitation” screen will be displayed.

Inch specifications

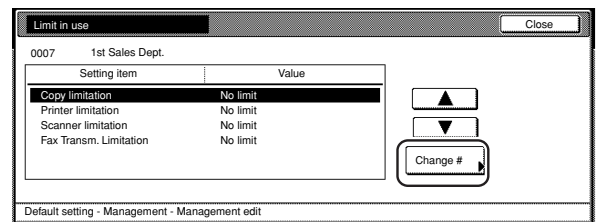

Metric specifications

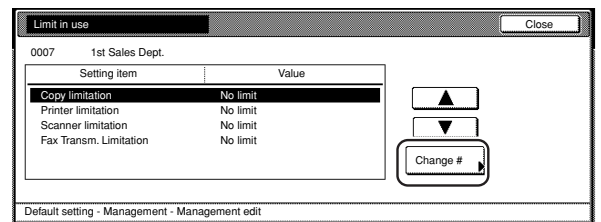

Section 7 COPIER MANAGEMENT FUNCTIONS

- 3** To set the maximum number of copies that can be made under this ID-code, touch the “Counter limit” key and proceed to the next step.

To allow unlimited copies, touch the “No limit” key, and to cancel copying privileges completely, touch the “Is not permitted” key and proceed to step 5.

Inch specifications

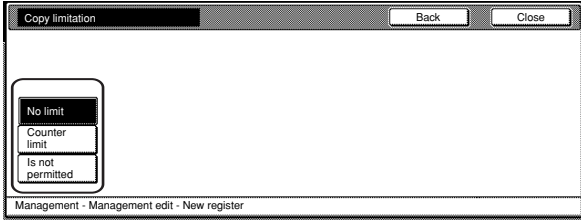

Metric specifications

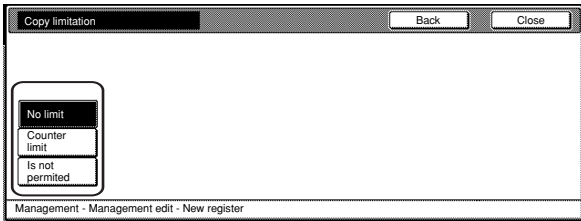

NOTE

If you want to quit the displayed setting without changing it, touch the “Back” key. The touch panel will return to the screen in step 2.

- 4** Use the numeric keys on the keypad to enter the maximum number of copies that can be made under this ID-code. The copy limit can be set to any 1-page increment up to 999,999.

Inch specifications

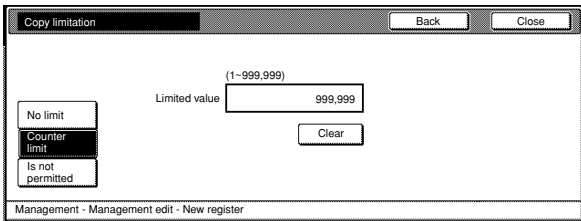

Metric specifications

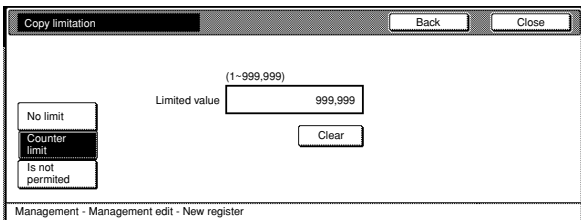

- 5** Touch the “Close” key. The touch panel will return to the screen in step 2.

Printing restrictions

Perform the following procedure when the optional Printer Kit or Printer/Scanner Kit is installed in your copier and you want to set the maximum number of printouts that can be made under the corresponding department ID-code.

NOTE

This setting will only be available when “On” is selected as the “Printer function management ON/OFF” setting.

- 1** Access the screen that contains the copy restriction setting items.

(See “Register new department ID-codes” on page 7-4 or “Change restrictions for use” on page 7-20.)

Inch specifications

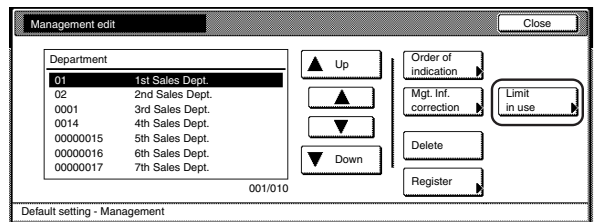

Metric specifications

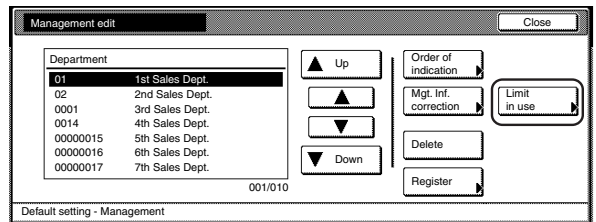

- 2 Select "Printer limitation" under the "Setting item" column on the left side of the touch panel and then touch the "Change #" key.
The "Printer limitation" screen will be displayed.

Inch specifications

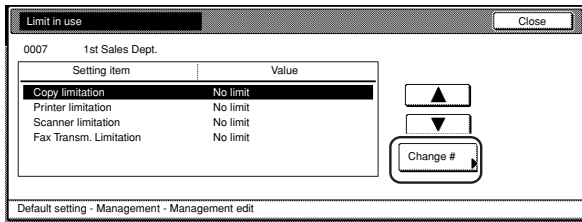

Metric specifications

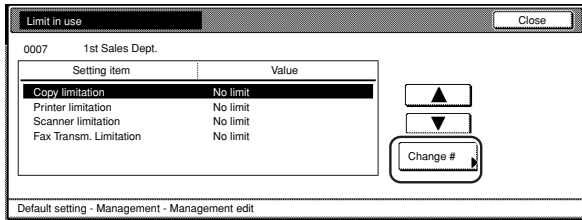

- 4 Use the numeric keys on the keypad to enter the maximum number of printouts that can be made under this ID-code. The printing limit can be set to any 1-page increment up to 999,999.

Inch specifications

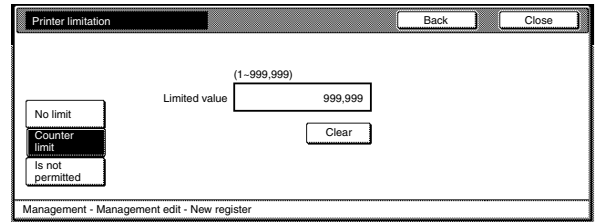

Metric specifications

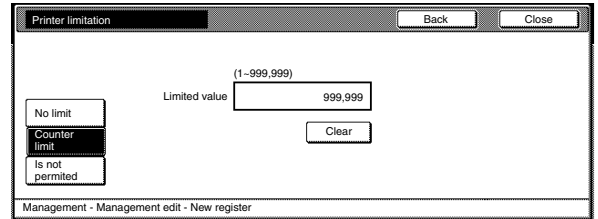

- 3 To set the maximum number of printouts that can be made under this ID-code, touch the "Counter limit" key and proceed to the next step.
To allow unlimited printing, touch the "No limit" key, and to cancel printing privileges completely, touch the "Is not permitted" key and proceed to step 5.

Inch specifications

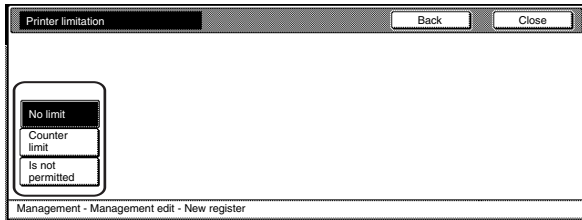

Metric specifications

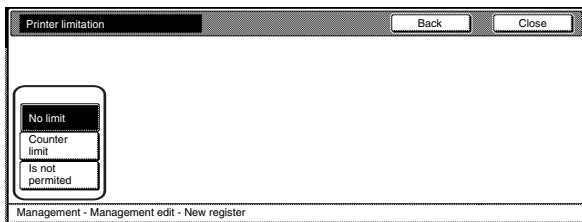

- 5 Touch the "Close" key.
The touch panel will return to the screen in step 2.

NOTE

If you want to quit the displayed setting without changing it, touch the "Back" key. The touch panel will return to the screen in step 2.

Section 7 COPIER MANAGEMENT FUNCTIONS

● Delete department ID-codes

Perform the following procedure when you want to delete registered department ID-codes.

- 1 Access the copy management menu screen.
(See “(2) Accessing the copy management menu screen” on page 7-3.)

Inch specifications

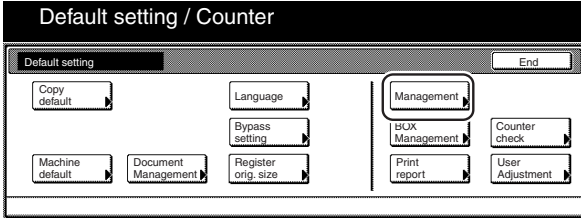

Metric specifications

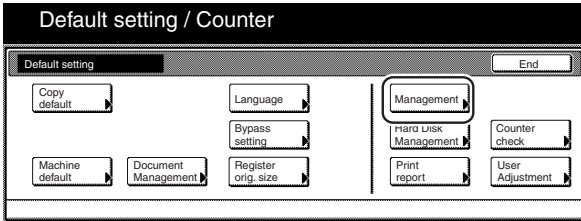

- 2 Touch the “Management edit” key.
The “Management edit” screen will be displayed.

Inch specifications

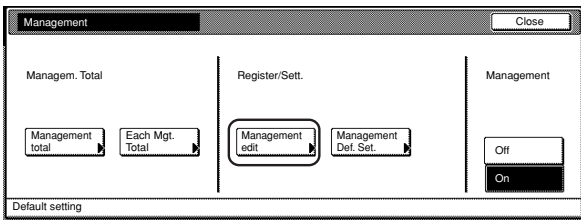

Metric specifications

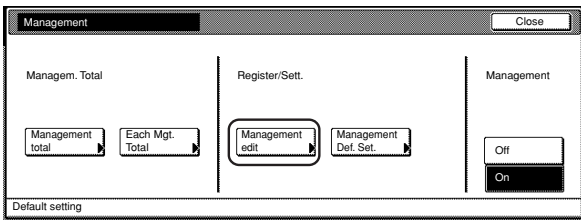

- 3 Select the department ID-code that you want to delete, and then touch the “Delete” key.

Inch specifications

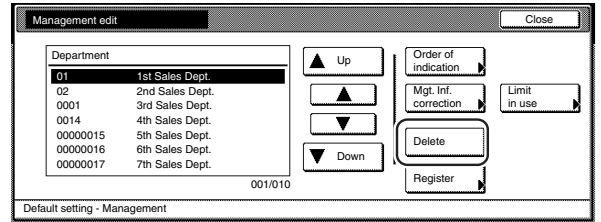

Metric specifications

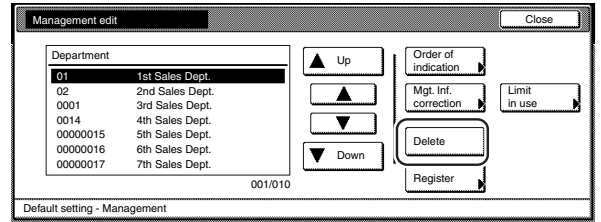

NOTE

It is possible for you to change the order of how the list of ID-codes is displayed.

To so, touch the “Order of indication” key and then touch the “Sort by code” key (and select either “1 → 9” or “9 → 1”) or the “Sort by Name” key (and select either “A → Z” or “Z → A”), as appropriate.

- 4 Verify that this is the ID-code that you want to delete, and touch the “Yes” key.
The touch panel will return to the screen in step 3.

Inch specifications

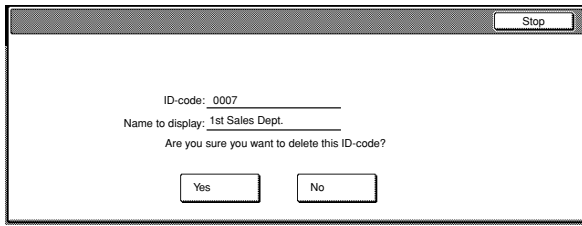

Metric specifications

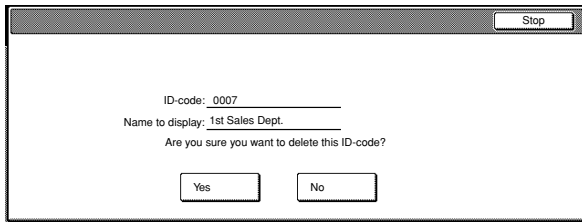

NOTE

If you want to delete another ID-code, repeat steps 3 and 4.

- 5 Touch the “Close” key.
The touch panel will return to the screen in step 2.

● **Change registered information**

Perform the following procedure when you want to change a previously registered department name or the corresponding ID-code.

- 1 Access the copy management menu screen.
(See “(2) Accessing the copy management menu screen” on page 7-3.)

Inch specifications

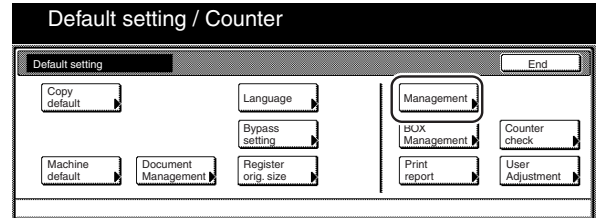

Metric specifications

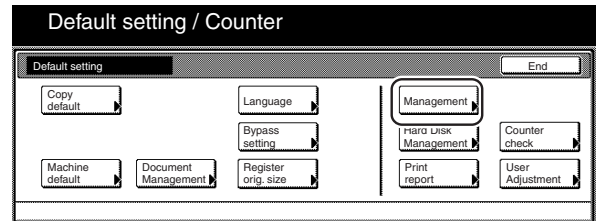

- 2 Touch the “Management edit” key.
The “Management edit” screen will be displayed.

Inch specifications

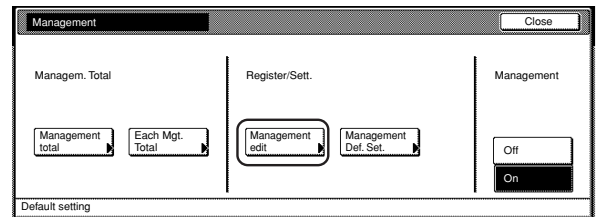

Metric specifications

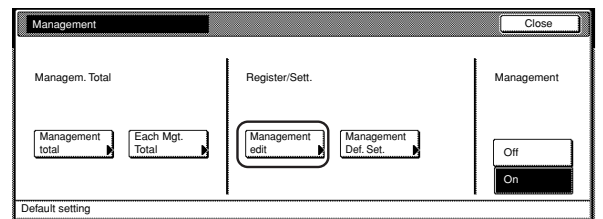

Section 7 COPIER MANAGEMENT FUNCTIONS

- 3** Select the department ID-code for which you want to change the registered information, and then touch the “Mgt. Inf. Correction” key.

The “Department inform. edit” [“Department info. Editing”] screen will be displayed.

Inch specifications

Metric specifications

To change the registered ID-code, proceed to the next step. To change the registered department name, proceed to step 7.

- 5** Touch the “Clear” key to delete the old ID-code. Use the numeric keys on the keypad to enter the new ID-code (up to 8 digits).

Inch specifications

Metric specifications

- 6** Touch the “Close” key. The touch panel will return to the screen in step 4. Proceed to step 10.

Inch specifications

Metric specifications

NOTE

It is possible for you to change the order of how the list of ID-codes is displayed.

To so, touch the “Order of indication” key and then touch the “Sort by code” key (and select either “1 → 9” or “9 → 1”) or the “Sort by Name” key (and select either “A → Z” or “Z → A”), as appropriate.

- 4** Select “ID-code” under the “Setting item” column on the left side of the touch panel and then touch the “Change #” key. The “ID-code” screen will be displayed.

Inch specifications

Metric specifications

- 7 Select "Name to display" under the "Setting item" column on the left side of the touch panel and then touch the "Change #" key.

The "Name to display" screen will be displayed.

Inch specifications

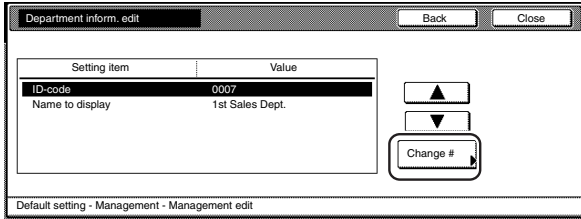

Metric specifications

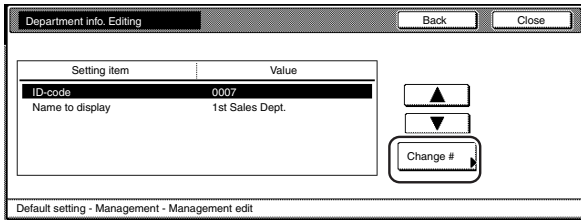

- 8 Touch the "AllDel." key to delete the old department name, then enter the new name.

Inch specifications

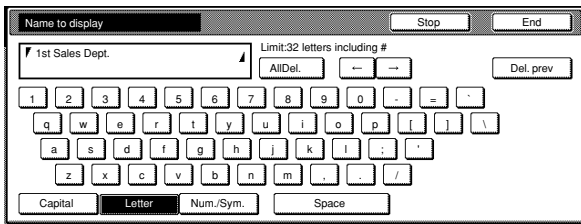

Metric specifications

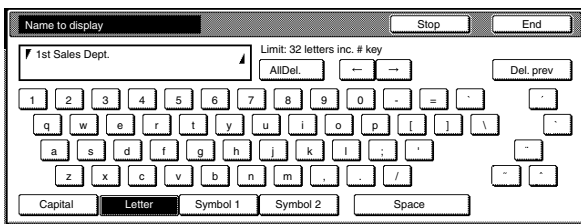

NOTE

For information on how to enter the department name, refer to "11. Entering characters" on page 7-104.

- 9 Touch the "End" key. The touch panel will return to the screen in step 7.
- 10 Touch the "Close" key. The touch panel will return to the screen in step 3.
- 11 Touch the "Close" key. The touch panel will return to the screen in step 2.
- 12 Touch the "Close" key.

Section 7 COPIER MANAGEMENT FUNCTIONS

● Change restrictions for use

Perform the following procedure when you want to change the restrictions for using the copier under each department ID-code.

IMPORTANT!

In order to access the “Change restrictions for use” procedure under “Editing copy management information”, it is necessary to select “On” under “Copier function management ON/OFF”. When the optional Printer Kit, Printer/Scanner Kit or Fax Kit are installed in your copier, it is necessary to select “On” under the corresponding “Printer function management ON/OFF”, “Scanner function management ON/OFF” or “Fax function management ON/OFF” procedure. (See “(6) Changing the copy management default settings” on page 7-25.)

- 1 Access the copy management menu screen. (See “(2) Accessing the copy management menu screen” on page 7-3.)

Inch specifications

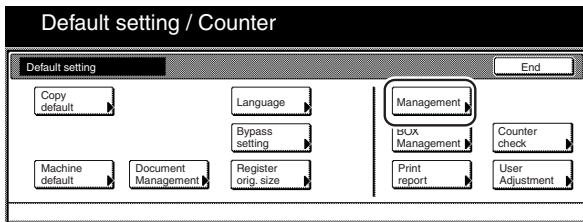

Metric specifications

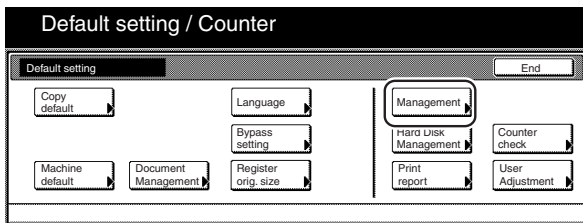

- 2 Touch the “Management edit” key. The “Management edit” screen will be displayed.

Inch specifications

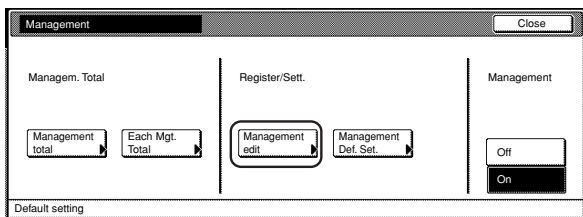

Metric specifications

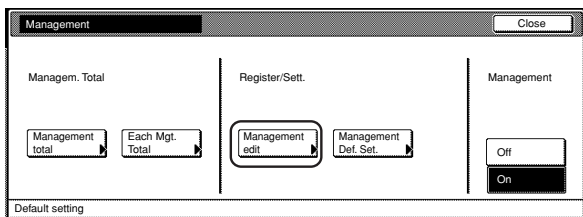

- 3 Select the department ID-code for which you want to change the restrictions, and then touch the “Limit in use” key. The “Limit in use” screen will be displayed.

Inch specifications

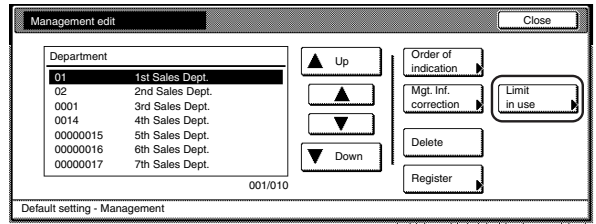

Metric specifications

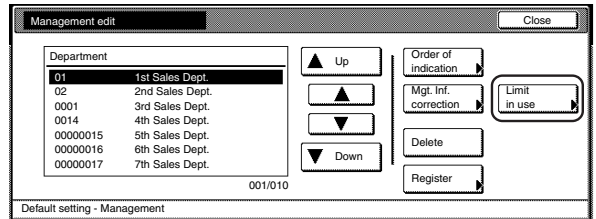

NOTE

It is possible for you to change the order of how the list of ID-codes is displayed. To so, touch the “Order of indication” key and then touch the “Sort by code” key (and select either “1 → 9” or “9 → 1”) or the “Sort by Name” key (and select either “A → Z” or “Z → A”), as appropriate.

- 4 Change the restrictions for using the copier under that department ID-code as desired.

Inch specifications

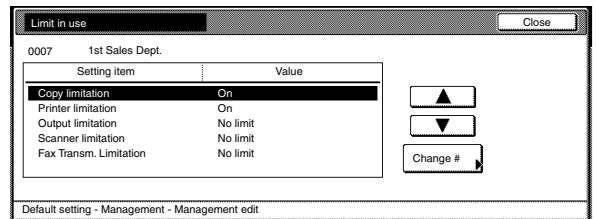

Metric specifications

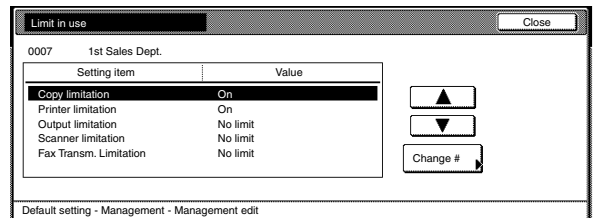

NOTE

For information on how to change restrictions, refer to “Setting the restrictions for use” on page 7-7.

- 5 Touch the "Close" key.
The touch panel will return to the screen in step 3.

Inch specifications

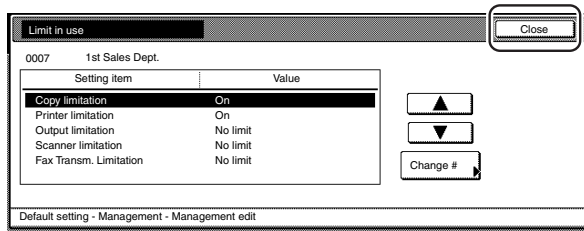

Metric specifications

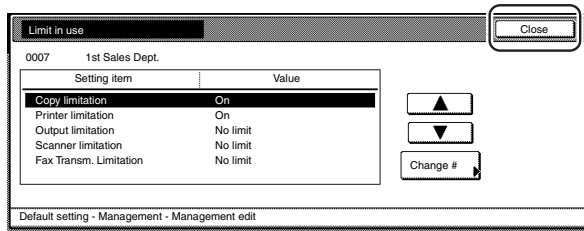

- 6 Touch the "Close" key.
The touch panel will return to the screen in step 2.

- 7 Touch the "Close" key.

(4) Checking the copy management counts

● Check all departments

Perform the following procedure when you want to check the total number of copies made under all department ID-codes as a whole, print out a copy management report and clear the copy counts for all of the registered department ID-codes.

- 1 Access the copy management menu screen.
(See "(2) Accessing the copy management menu screen" on page 7-3.)

Inch specifications

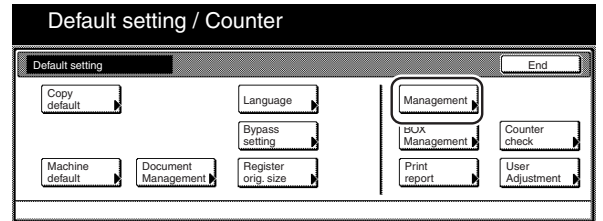

Metric specifications

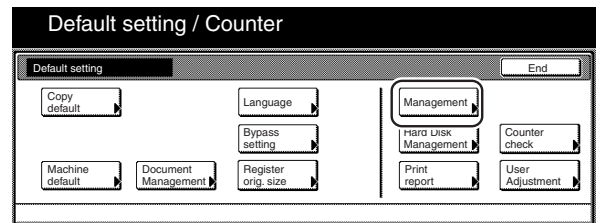

- 2 Touch the "Management total" key.
The "Management total" screen will be displayed.

Inch specifications

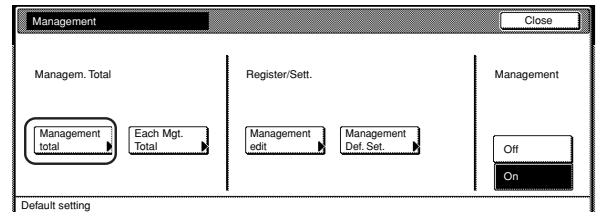

Metric specifications

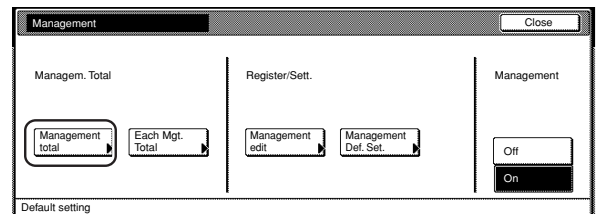

Section 7 COPIER MANAGEMENT FUNCTIONS

- 3** The total number of copies made under all department ID-codes as a whole will be displayed. If you want to print out a copy management report, touch the "Print report" key.

Inch specifications

Management Total [Close]

| Number print. | Copy | Printer | Fax | Total |
|----------------|------|---------|-----|-------|
| Black & White: | 300 | 100 | 50 | 450 |

| Scan.Transm. | Scanner | Fax Transm. | Fax |
|---------------|---------|----------------|-------------|
| Scan # pages: | 100 | Trsm. # pages: | 100 |
| | | Commun.Time: | 1Hrs.10Mins |

Default setting - Management

[Counter clear] [Print report]

Metric specifications

Management Total [Close]

| Number print. | Copy | Printer | Fax | Total |
|----------------|------|---------|-----|-------|
| Black & White: | 300 | 100 | 50 | 450 |

| Scan.Transm. | Scanner | Fax transm. | Fax |
|---------------|---------|----------------|-------------|
| Scan # pages: | 100 | Trsm. # pages: | 100 |
| | | Commun.Time: | 1Hrs.10Mins |

Default setting - Management

[Counter clear] [Print report]

- 5** When the confirmation message appears, touch the "Yes" key.

Inch specifications

Stop

The counted number for this ID-code will be deleted
Are you sure?

[Yes] [No]

Metric specifications

Stop

The counted number for this ID-code will be deleted
Are you sure?

[Yes] [No]

- 6** Touch the "Close" key.
The touch panel will return to the screen in step 2.

- 7** Touch the "Close" key.

NOTES

- The type of report printed out will vary according the setting selected for "Copy/Printer output management" under the copy management default settings.
- If any of the "Total size 1" through "Total size 5" settings is selected under the copy management default settings, the total size report will also be printed out.

- 4** To clear all of the copy counts, touch the "Counter clear" key.

Inch specifications

Management Total [Close]

| Number print. | Copy | Printer | Fax | Total |
|----------------|------|---------|-----|-------|
| Black & White: | 300 | 100 | 50 | 450 |

| Scan.Transm. | Scanner | Fax Transm. | Fax |
|---------------|---------|----------------|-------------|
| Scan # pages: | 100 | Trsm. # pages: | 100 |
| | | Commun.Time: | 1Hrs.10Mins |

Default setting - Management

[Counter clear] [Print report]

Metric specifications

Management Total [Close]

| Number print. | Copy | Printer | Fax | Total |
|----------------|------|---------|-----|-------|
| Black & White: | 300 | 100 | 50 | 450 |

| Scan.Transm. | Scanner | Fax transm. | Fax |
|---------------|---------|----------------|-------------|
| Scan # pages: | 100 | Trsm. # pages: | 100 |
| | | Commun.Time: | 1Hrs.10Mins |

Default setting - Management

[Counter clear] [Print report]

● Check individual departments

Perform the following procedure when you want to check the total number of copies made under each individual department ID-code and/or clear the copy counts for individual departments as well.

- 1 Access the copy management menu screen.
(See “(2) Accessing the copy management menu screen” on page 7-3.)

Inch specifications

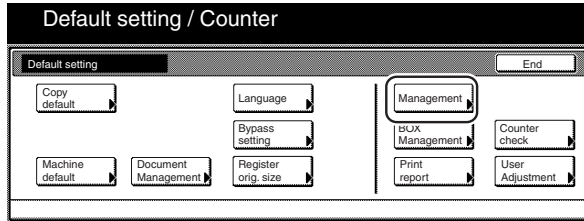

Metric specifications

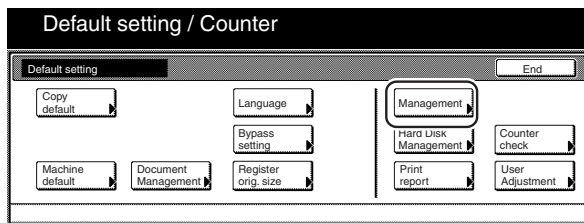

- 2 Touch the “Each Mgt. Total” key.
The “Each Management Total” screen will be displayed.

Inch specifications

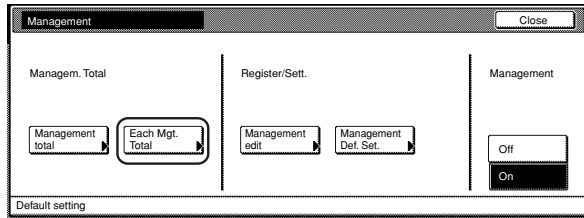

Metric specifications

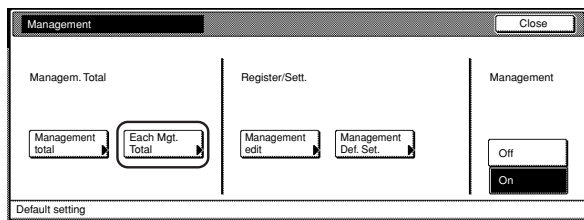

- 3 Select the department ID-code for which you want to check the copy counts, and then touch the “Total” key.

Inch specifications

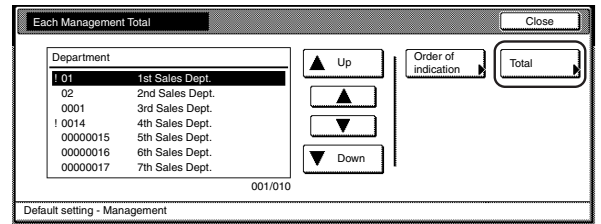

Metric specifications

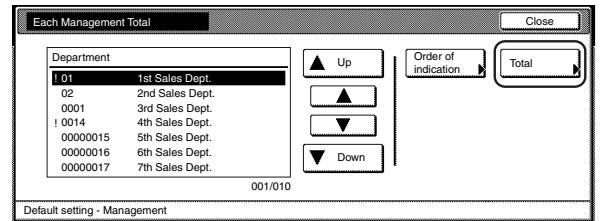

NOTES

- The “---ETC” displayed in the list indicates the number of printouts that were made without entering an ID-code.
 - The printouts included under “---ETC” are as follows:
 - Report print out
 - Printer error report print out
 - Print out from a computer for which an ID-code is not set (When the “Non-standard printer driver printout (Printer)” is set to “ON” under the copy management default settings.)
 - Fax reception print out
 - Fax report print out
- It is possible for you to change the order of how the list of ID-codes is displayed. To so, touch the “Order of indication” key and then touch the “Sort by code” key (and select either “1 → 9” or “9 → 1”) or the “Sort by Name” key (and select either “A → Z” or “Z → A”), as appropriate.

Section 7 COPIER MANAGEMENT FUNCTIONS

- 4** The total number of copies made under that department ID-code will be displayed.

Inch specifications

| Each Management Total | | | | Close |
|------------------------------|---------|----------------|-----------------|---------------------------------|
| Number print. | Copy | Printer | Total | Number in () is limit value |
| Black & White: | 50 | 30 | 80 | |
| Scan.Transm. | Scanner | Fax Transm. | Fax | Counter clear |
| Scan # pages: | 100 | Trsm. # pages: | 100 | |
| | | Commun.Time: | 1Hrs.10Mins | |
| Default setting - Management | | 0007 | 1st Sales Dept. | |

Metric specifications

| Each Management Total | | | | Close |
|------------------------------|---------|----------------|-----------------|---------------------------------|
| Number print. | Copy | Printer | Total | Number in () is limit value |
| Black & White: | 50 | 30 | 80 | |
| Scan.Transm. | Scanner | Fax transm. | Fax | Counter clear |
| Scan # pages: | 100 | Trsm. # pages: | 100 | |
| | | Commun.Time: | 1Hrs.10Mins | |
| Default setting - Management | | 0007 | 1st Sales Dept. | |

- 6** When the confirmation message appears, touch the "Yes" key.

Inch specifications

The count value of this ID-code will be deleted
Are you sure?

Yes No

Metric specifications

The count value of this ID-code will be deleted
Are you sure?

Yes No

NOTE

On the "Each Management Total" screen, the number in the brackets following the number of copies made indicates the maximum number of copies that can be made.

- 5** To clear all of the copy counts for that ID-code, touch the "Counter clear" key.

Inch specifications

| Each Management Total | | | | Close |
|------------------------------|---------|----------------|-----------------|---------------------------------|
| Number print. | Copy | Printer | Total | Number in () is limit value |
| Black & White: | 50 | 30 | 80 | |
| Scan.Transm. | Scanner | Fax Transm. | Fax | Counter clear |
| Scan # pages: | 100 | Trsm. # pages: | 100 | |
| | | Commun.Time: | 1Hrs.10Mins | |
| Default setting - Management | | 0007 | 1st Sales Dept. | |

Metric specifications

| Each Management Total | | | | Close |
|------------------------------|---------|----------------|-----------------|---------------------------------|
| Number print. | Copy | Printer | Total | Number in () is limit value |
| Black & White: | 50 | 30 | 80 | |
| Scan.Transm. | Scanner | Fax transm. | Fax | Counter clear |
| Scan # pages: | 100 | Trsm. # pages: | 100 | |
| | | Commun.Time: | 1Hrs.10Mins | |
| Default setting - Management | | 0007 | 1st Sales Dept. | |

- 7** Touch the "Close" key.
The touch panel will return to the screen in step 3.

- 8** Touch the "Close" key.
The touch panel will return to the screen in step 2.

- 9** Touch the "Close" key.

(5) Turning the copy management function ON/OFF

Perform the following procedure when you want to turn copy management ON or OFF.

- 1 Access the copy management menu screen. (See “(2) Accessing the copy management menu screen” on page 7-3.)

Inch specifications

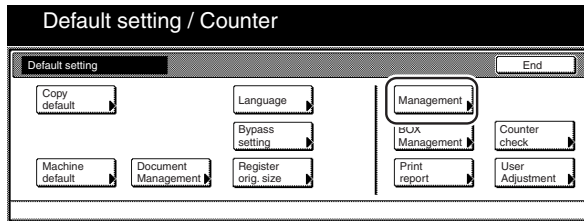

Metric specifications

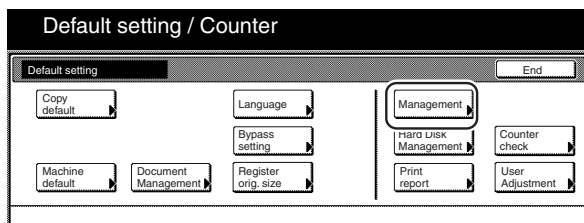

- 2 To turn copy management ON, touch the “On” key. To turn copy management OFF, touch the “Off” key.

Inch specifications

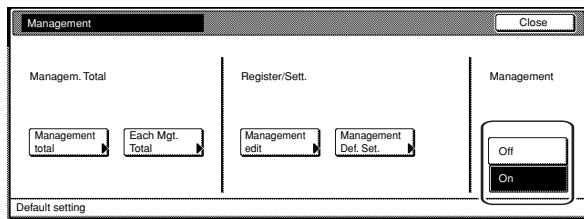

Metric specifications

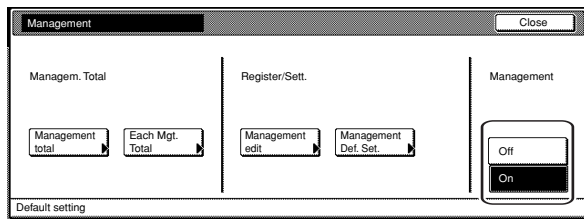

- 3 Touch the “Close” key.

(6) Changing the copy management default settings

Perform the following procedure when you want to change the default settings for the copy management function.

The following default settings are available.

- Copier function management ON/OFF (Page 7-26.)
- Printer function management ON/OFF (Page 7-27.)
- Printer error report (Page 7-28.)
- Non-standard printer driver printout (Printer) (Page 7-29.)
- Copy/Printer output management (Page 7-30.)
- Scanner function management ON/OFF (Page 7-31.)
- Fax function management ON/OFF (Page 7-32.)
- Response to exceeded restriction (Page 7-33.)
- Default copy limit (Page 7-34.)
- Total count for specified paper size (1 to 5) (Page 7-35)

● **Accessing the copy management default settings**

- 1 Access the copy management menu screen. (See “(2) Accessing the copy management menu screen” on page 7-3.)

Inch specifications

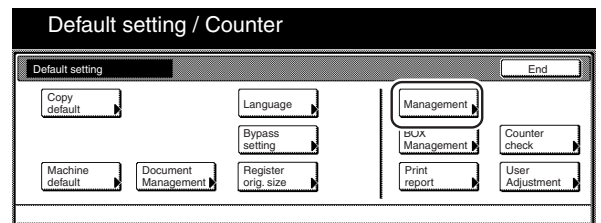

Metric specifications

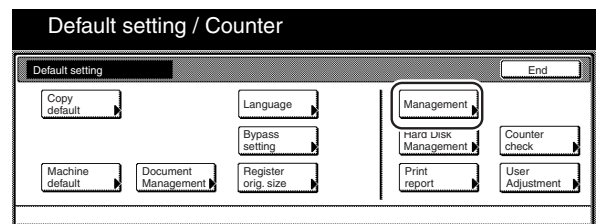

Section 7 COPIER MANAGEMENT FUNCTIONS

- 2 Touch the "Management Def. Set." key.
The "Managem. Def. Set." screen will be displayed.

Inch specifications

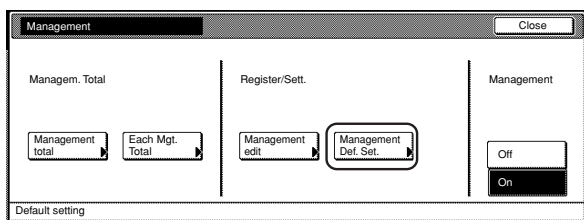

Metric specifications

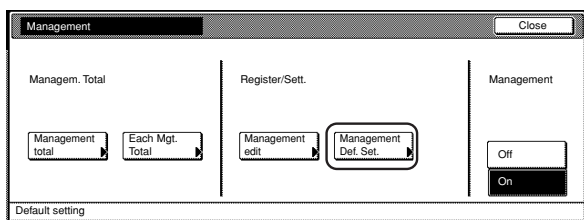

- 3 Select the default setting that you want to change and then touch the "Change #" key.

Inch specifications

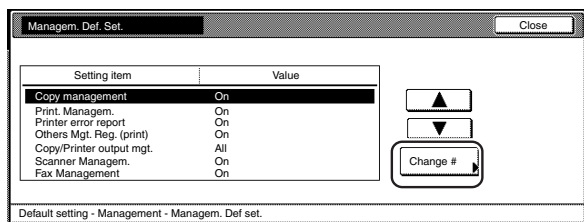

Metric specifications

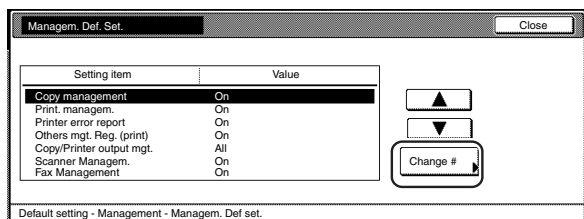

● Copier function management ON/OFF

Perform the following procedure when you want to turn copy management ON or OFF for the copier functions of this machine.

- 1 Select "Copy management" under the "Setting item" column on the left side of the touch panel and then touch the "Change #" key.

The "Copy management" screen will be displayed.

Inch specifications

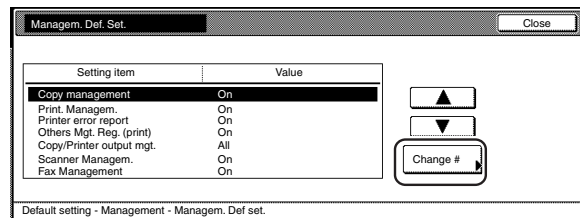

Metric specifications

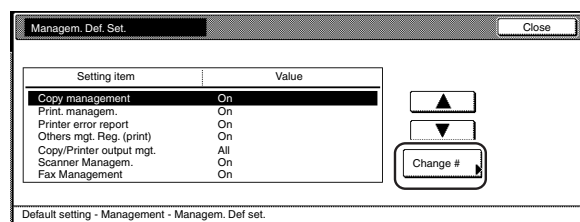

- 2 To turn copy management ON for the copier functions of this machine, touch the "On" key.

Inch specifications

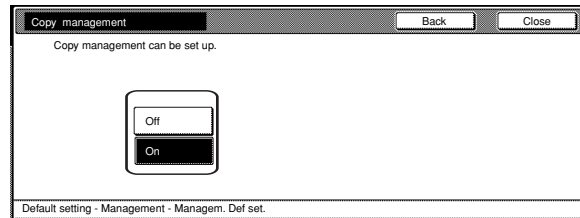

Metric specifications

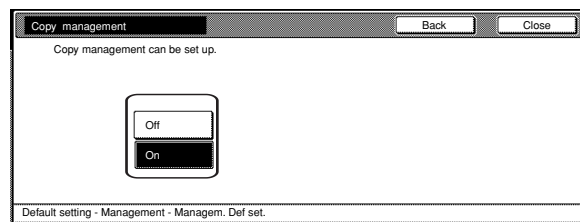

NOTE

Perform the following procedure that corresponds to the desired setting.

NOTE

If you want to quit the displayed setting without changing it, touch the "Back" key. The touch panel will return to the screen in step 1.

- 3 Touch the "Close" key.
The touch panel will return to the screen in step 1.

● Printer function management ON/OFF

Perform the following procedure when you want to turn copy management ON or OFF for the printer functions of this machine.

NOTE

This setting is only available when the optional Printer Kit or Printer/Scanner Kit is installed in your copier.

- 1 Select "Print. Managem." under the "Setting item" column on the left side of the touch panel and then touch the "Change #" key. The "Print. Managem." screen will be displayed.

Inch specifications

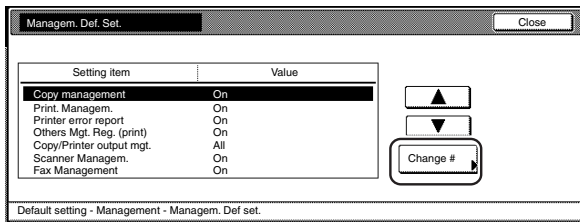

Metric specifications

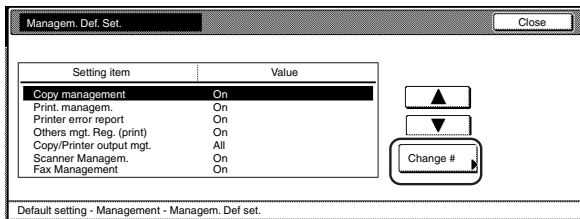

- 2 To turn copy management ON for the printer functions of this machine, touch the "On" key.

Inch specifications

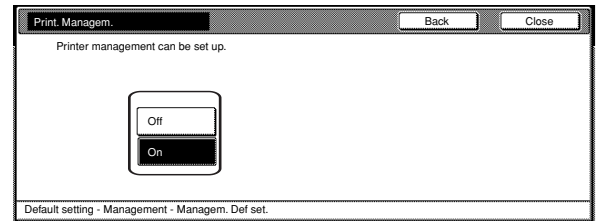

Metric specifications

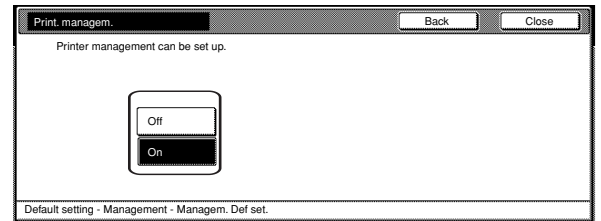

NOTE

If you want to quit the displayed setting without changing it, touch the "Back" key. The touch panel will return to the screen in step 1.

- 3 Touch the "Close" key. The touch panel will return to the screen in step 1.

Section 7 COPIER MANAGEMENT FUNCTIONS

● Printer error report

Perform the following procedure if you want an error report printed anytime "On" is selected as the "Printer function management ON/OFF" setting and printing is attempted with an invalid department ID-code.

NOTE

This setting will only be available when "On" is selected as the "Printer function management ON/OFF" setting.

- 1 Select "Printer error report" under the "Setting item" column on the left side of the touch panel and then touch the "Change #" key. The "Printer error report" screen will be displayed.

Inch specifications

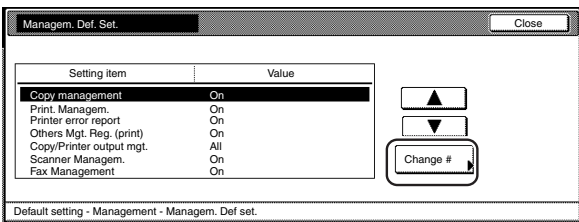

Metric specifications

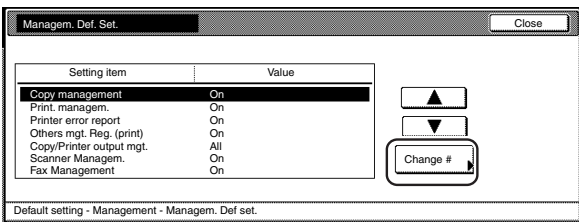

- 2 To have a printer error report printed out, touch the "On" key. If you do not want the printer error report printed out, touch the "Off" key.

Inch specifications

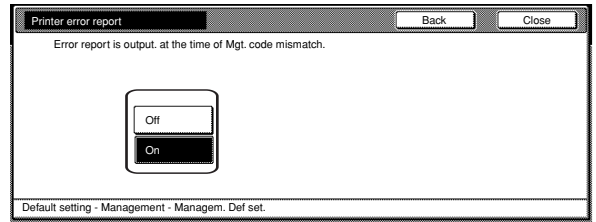

Metric specifications

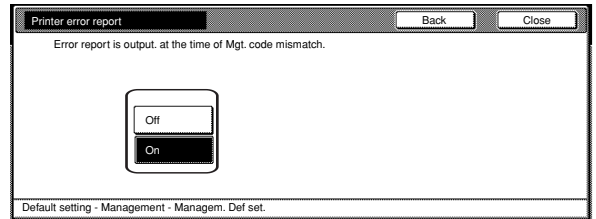

NOTE

If you want to quit the displayed setting without changing it, touch the "Back" key. The touch panel will return to the screen in step 1.

- 3 Touch the "Close" key. The touch panel will return to the screen in step 1.

NOTE

If anyone attempts to print using an invalid department ID-code, an error will occur under the printing functions and printout will not be possible. When the [Printer] key is touched, "Department ID-code mismatch." will be displayed. Touch the "GO" key to print out an error report.

Inch specifications

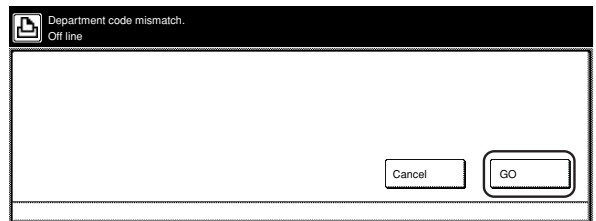

Metric specifications

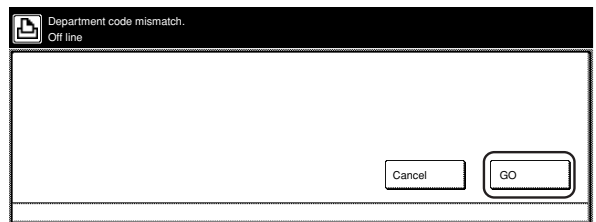

● Non-standard printer driver printout (Printer)

Perform the following procedure when “On” is selected as the “Printer function management ON/OFF” setting and you want to want to allow the use of printer drivers other than those available under copy management.

NOTE

This setting will only be available when “On” is selected as the “Printer function management ON/OFF” setting.

- 1 Select “Others Mgt. Reg. (print)” under the “Setting item” column on the left side of the touch panel and then touch the “Change #” key. The “Others Mgt. Reg. (print)” screen will be displayed.

Inch specifications

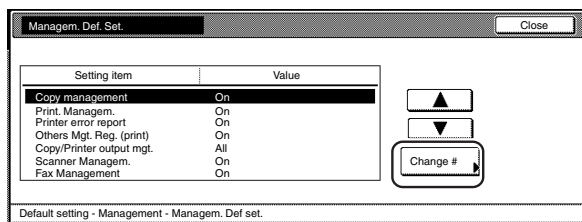

Metric specifications

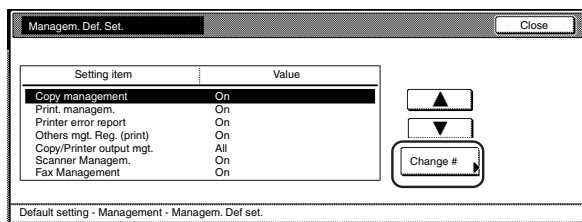

- 2 To allow the use of printer drivers other than those available under copy management, touch the “On” key.

Inch specifications

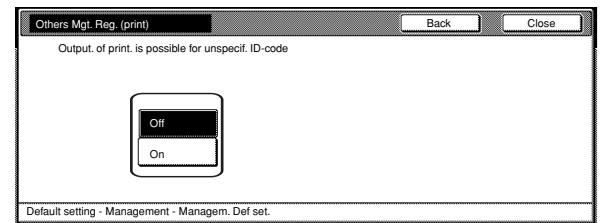

Metric specifications

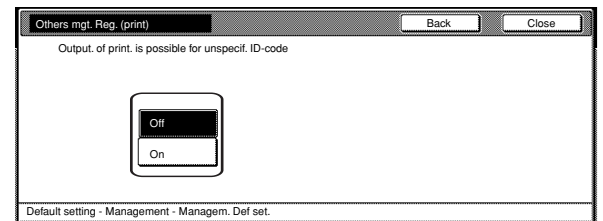

NOTE

If you want to quit the displayed setting without changing it, touch the “Back” key. The touch panel will return to the screen in step 1.

- 3 Touch the “Close” key. The touch panel will return to the screen in step 1.

Section 7 COPIER MANAGEMENT FUNCTIONS

● Copy/Printer output management

Perform the following procedure to determine whether management of copier and printer functions will be handled together or separately.

NOTE

If this setting is changed, it will affect which setting items are available for restriction under the copy management function. (See “Setting the restrictions for use” on page 7-7.)

- 1 Select “Copy/Printer output mgt.” under the “Setting item” column on the left side of the touch panel and then touch the “Change #” key.

The “Copy/Printer output mgt.” screen will be displayed.

Inch specifications

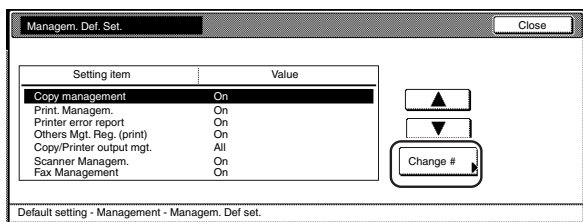

Metric specifications

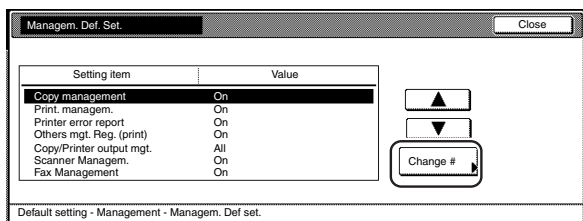

- 2 To have copier and printer functions both handled together, touch the “All” key. To have copier and printer functions each handled separately, touch the “Each” key.

Inch specifications

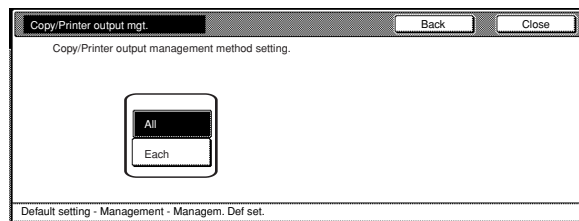

Metric specifications

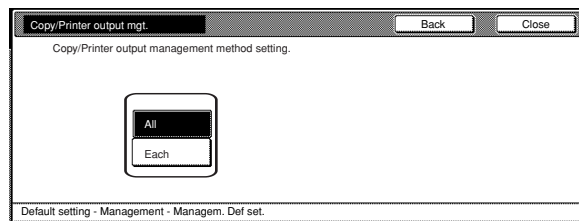

NOTE

If you want to quit the displayed setting without changing it, touch the “Back” key. The touch panel will return to the screen in step 1.

- 3 Touch the “Close” key. The touch panel will return to the screen in step 1.

● Scanner function management ON/OFF

Perform the following procedure when you want to turn copy management ON or OFF for the scanner functions of this machine.

NOTE

This setting is only available when the optional Printer/Scanner Kit is installed in your copier.

- 1 Select "Scanner Managem." under the "Setting item" column on the left side of the touch panel and then touch the "Change #" key. The "Scanner Managem." screen will be displayed.

Inch specifications

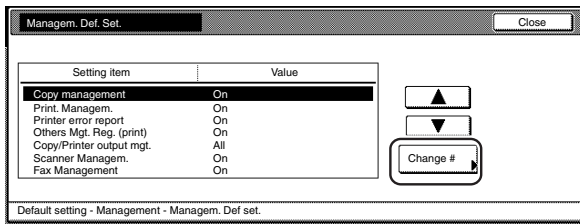

Metric specifications

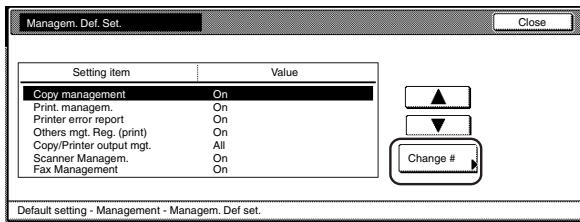

- 2 To turn copy management ON for the scanner functions of this machine, touch the "On" key.

Inch specifications

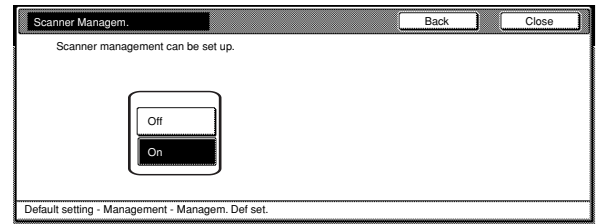

Metric specifications

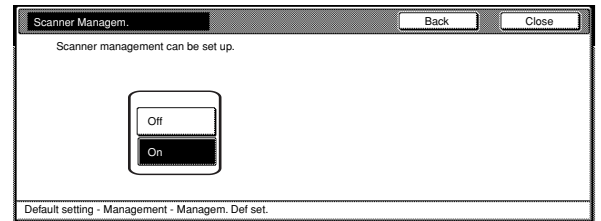

NOTE

If you want to quit the displayed setting without changing it, touch the "Back" key. The touch panel will return to the screen in step 1.

- 3 Touch the "Close" key. The touch panel will return to the screen in step 1.

Section 7 COPIER MANAGEMENT FUNCTIONS

● Fax function management ON/OFF

Perform the following procedure when you want to turn copy management ON or OFF for the fax functions of this machine.

NOTE

This setting is only available when the optional Fax Kit is installed in your copier.

- 1 Select "Fax Management" under the "Setting item" column on the left side of the touch panel and then touch the "Change #" key.

The "Fax Management" screen will be displayed.

Inch specifications

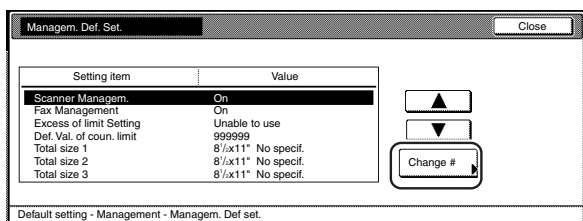

Metric specifications

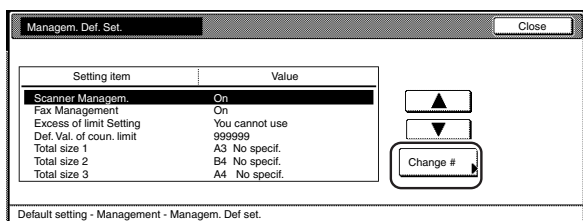

- 2 To turn copy management ON for the fax functions of this machine, touch the "On" key.

Inch specifications

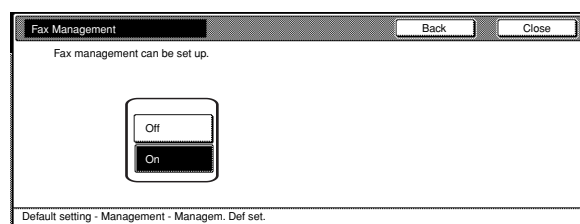

Metric specifications

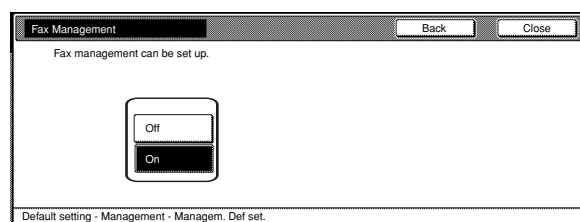

NOTE

If you want to quit the displayed setting without changing it, touch the "Back" key. The touch panel will return to the screen in step 1.

- 3 Touch the "Close" key.
The touch panel will return to the screen in step 1.

● Response to exceeded restriction

Perform the following procedure to determine whether further use of the machine by the corresponding department will be discontinued immediately (starting with the current job) or with the next job, or if only an error message will be generated when a department ID-code has exceeded its set limit.

NOTE

If the optional Printer/Scanner Kit or Fax Kit is installed on your copier, even if you select here to have further use of the machine discontinued immediately (starting with the current job), if a department ID-code exceeds its set limit during scanning or during fax transmission, the actual restriction will start from the next job.

- 1 Select "Excess of limit Setting" under the "Setting item" column on the left side of the touch panel and then touch the "Change #" key.

The "Excess of limit Setting" screen will be displayed.

Inch specifications

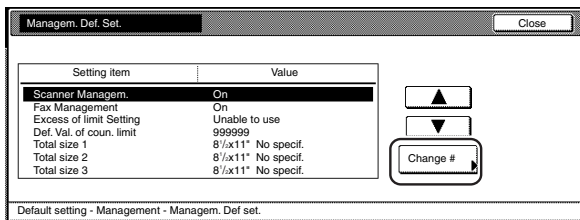

Metric specifications

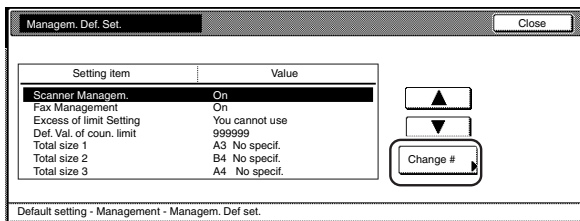

- 2 To discontinue further use of the machine immediately (starting with the current job) when a department ID-code has exceeded its set limit, touch the "Stop job immediately" key. To cancel further use of the machine starting from the next job, touch the "Stop after job done" key. To have an error message generated, touch the "Only warning" key.

Inch specifications

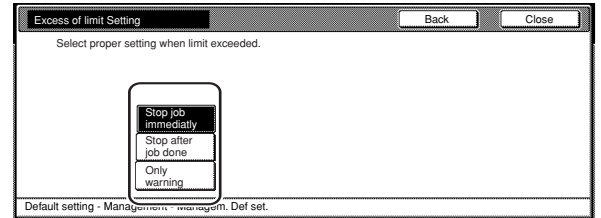

Metric specifications

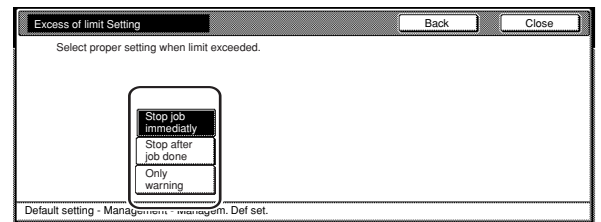

NOTE

If you want to quit the displayed setting without changing it, touch the "Back" key. The touch panel will return to the screen in step 1.

- 3 Touch the "Close" key.
The touch panel will return to the screen in step 1.

Section 7 COPIER MANAGEMENT FUNCTIONS

● Default copy limit

Perform the following procedure when you want to change the default copy limit for new department ID-codes.

- 1 Select "Def. Val. of coun. limit" under the "Setting item" column on the left side of the touch panel and then touch the "Change #" key.

The "Def. Val. of coun. limit" screen will be displayed.

Inch specifications

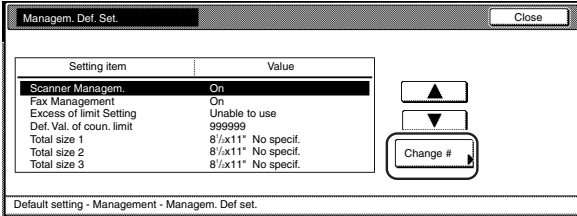

Metric specifications

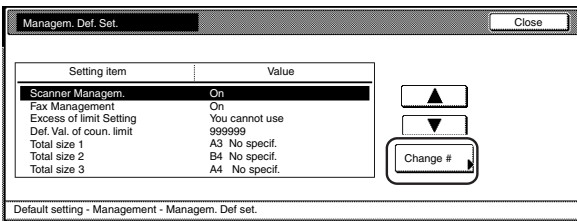

- 2 Use the numeric keys on the keypad to enter the default copy limit. The limit can be set to any 1-page increment up to 999,999.

Inch specifications

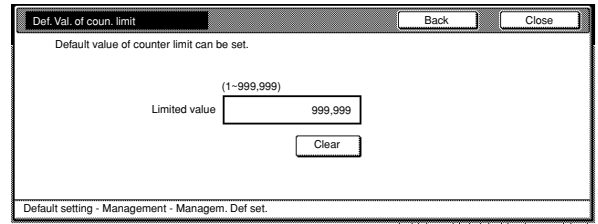

Metric specifications

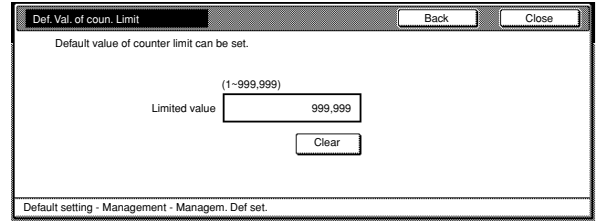

NOTE

If you want to quit the displayed setting without changing it, touch the "Back" key. The touch panel will return to the screen in step 1.

- 3 Touch the "Close" key.
The touch panel will return to the screen in step 1.

● Total count for specified paper size (1 to 5)

Perform the following procedure when you want to register a specific paper size in order to calculate and check the copy counts for that particular size of paper. It is also possible to register a paper size AND type.

NOTES

- You can register up to 5 different paper sizes for this function.
- If the type of paper is not registered in any of the settings, the corresponding copy counts for that size of paper will be calculated regardless of the type of paper that is used. However, if the same size of paper is registered in another setting along with a paper type, the counts for the first setting will NOT include copies made with the type of paper that is registered in the second setting.

1 Select one of the “Total size 1” through “Total size 5” settings under the “Setting item” column on the left side of the touch panel and then touch the “Change #” key. The corresponding setting screen will be displayed.

Inch specifications

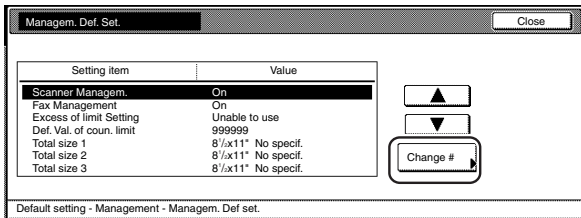

Metric specifications

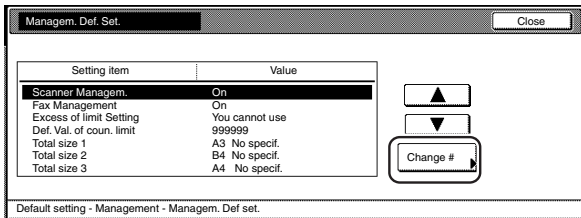

2 Touch the “On” key.

Inch specifications

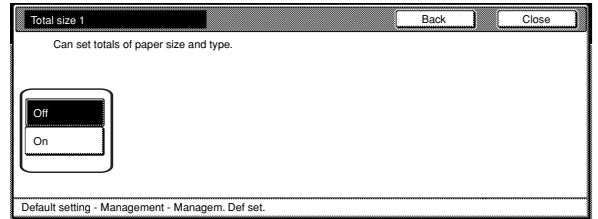

Metric specifications

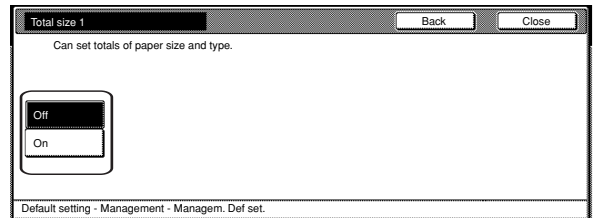

3 Touch the “Select size” key.

Inch specifications

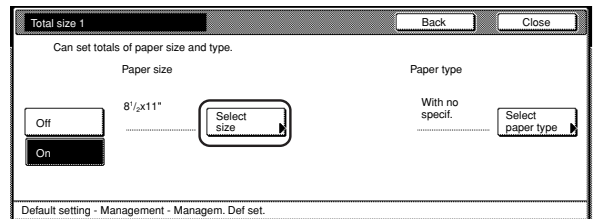

Metric specifications

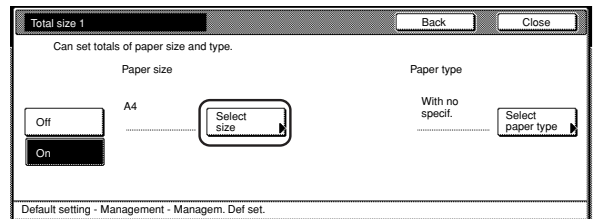

NOTE

If you want to quit the displayed setting without changing it, touch the “Back” key. The touch panel will return to the screen in step 1.

Section 7 COPIER MANAGEMENT FUNCTIONS

- 4** Touch the key that corresponds to the desired paper size, and then touch the “Close” key.

Inch specifications

| | | |
|----|-------|--------------------|
| A3 | B4 | 11x17" |
| A4 | B5 | 8 1/2 x 14" |
| A5 | Folio | 8 1/2 x 11" |
| | | 5 1/2 x 8 1/2" |

Management - Managem. Def set. - Total size 1

Metric specifications

| | | |
|-----------|-------|----------------|
| A3 | B4 | 11x17" |
| A4 | B5 | 8 1/2 x 14" |
| A5 | Folio | 8 1/2 x 11" |
| | | 5 1/2 x 8 1/2" |

Management - Managem. Def set. - Total size 1

- 5** To specify a paper type as well, touch the “Select paper type” key and proceed to the next step. If you do not want to specify a paper type, proceed to step 7.

Inch specifications

Total size 1

Can set totals of paper size and type.

Paper size: 8 1/2 x 11" [Select size]

Paper type: With no specif. [Select paper type]

Off On

Default setting - Management - Managem. Def set.

Metric specifications

Total size 1

Can set totals of paper size and type.

Paper size: A4 [Select size]

Paper type: With no specif. [Select paper type]

Off On

Default setting - Management - Managem. Def set.

- 6** Touch the key that corresponds to the desired paper type, and then touch the “Close” key.

Inch specifications

| | | | | | | |
|-----------------|--------------|------------|------------|--------------|----------|----------|
| With no specif. | Plain | Labels | Cardstock | Thick paper | Custom 1 | Custom 5 |
| | Transparency | Recycled | Color | Envelope | Custom 2 | Custom 6 |
| | Rough | Preprinted | Prepunched | | Custom 3 | Custom 7 |
| | Vellum | Bond | Letterhead | High quality | Custom 4 | Custom 8 |

Management - Managem. Def set. - Total size 1

Metric specifications

| | | | | | | |
|-----------------|--------------|------------|------------|--------------|----------|----------|
| With no specif. | Plain | Labels | Cardstock | Thick paper | Custom 1 | Custom 5 |
| | Transparency | Recycled | Colour | Envelope | Custom 2 | Custom 6 |
| | Rough | Preprinted | Prepunched | | Custom 3 | Custom 7 |
| | Vellum | Bond | Letterhead | High quality | Custom 4 | Custom 8 |

Management - Managem. Def set. - Total size 1

- 7** Touch the “Close” key.
The touch panel will return to the screen in step 1.

NOTE

You can check the copy counts for the paper sizes registered under the “Total size 1” through “Total size 5” settings on the total size report that is printed together with the copy management report. For information on how to print out a copy management report, refer to “Check all departments” on page 7-21.

(7) Making copies when copy management is turned ON

When copy management is turned ON, copying will only be possible when a valid department ID-code is entered.

IMPORTANT!

Once you are finished copying, BE SURE to press the [Management] key so that the “Enter ID-code” screen is displayed again.

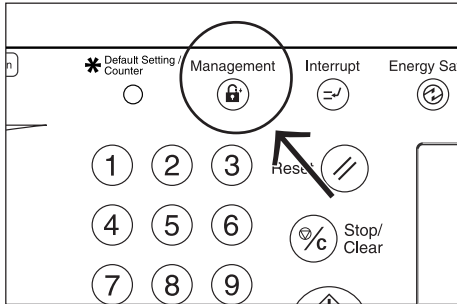

- 1 Use the numeric keys on the keypad to enter your department ID-code, and then touch the “Enter” key. The “Basic” screen will be displayed.

Inch specifications

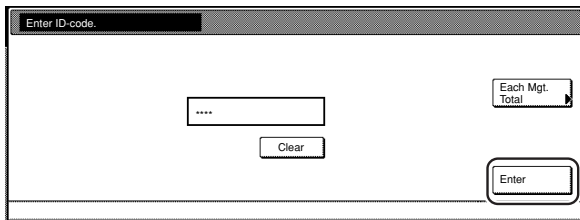

Metric specifications

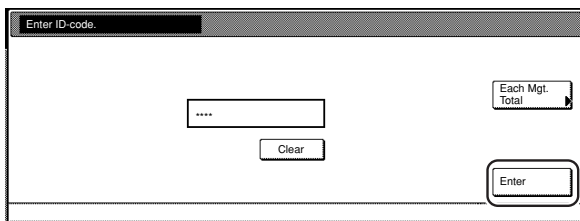

NOTES

- If you enter the wrong ID-code, touch the “clear” key and reenter the correct ID-code.
- If an invalid (unregistered) department ID-code is entered, an error alarm will sound. Enter the correct ID-code.
- If you enter your department ID-code and touch the “Each Mgt. Total” key, you can check the copy counts for your own department.

Inch specifications

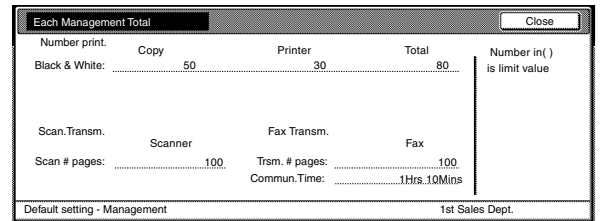

Metric specifications

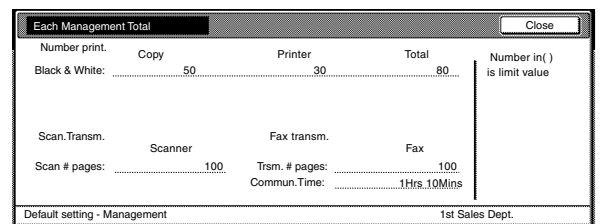

- 2 Perform the desired copy operation as usual.
- 3 Once you are finished copying, press the [Management] key.

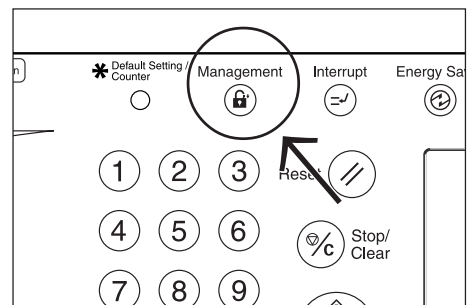

2. Default settings











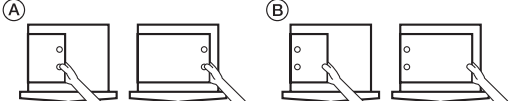

The state that the copier enters at the end of warm-up or when the [Reset] key is pressed is called the “initial mode”. The modes, functions and other settings that are automatically pre-set for the initial mode are called “default settings”. These default settings are separated into two categories: “Copy defaults” and “Machine defaults” and can be changed as desired to suit your copying needs.

(1) Machine default settings

The following table indicates the machine default settings available in this copier. Change any or all of the settings as desired in order to make the most effective use of your copier.

| Default setting | Description | Available settings | Factory setting | Reference page |
|---|---|---|--|----------------|
| Auto drawer[cassette] switching ON/OFF | If the paper in one drawer[cassette] runs out during copying, the automatic drawer[cassette] switching function will switch paper feed from the empty drawer[cassette] to another drawer[cassette] that contains the same size of paper in the same orientation for uninterrupted copying. To enable this function, it is necessary to turn the related setting “On”. | On / Off | On | 7-42 |
| | In order to prevent a drawer[cassette] that holds a different type of paper from being switched to when the automatic drawer[cassette] switching function is turned ON, it is necessary to select “Feed same paper type” as well. | All types of paper / Feed same paper type | All types of paper | |
| Paper size (drawer[cassette] No.1 – No.4) | Sets the size of paper that is loaded in drawers[cassettes] No.1 through No.4. If you want the size to be detected automatically, select “Auto Detection” (Automatic size detection). If you want to manually set the size of paper, select “Standard sizes”. | Auto Detection / Standard sizes | Auto Detection | 7-43 |
| | <If you select “Auto Detection”> You can also select the desired unit of measurement: “Inch” or “Centimeter”. | Inch Centimeter | Inch specification: Inch Metric specification: Centimeter | |
| | <If you select “Standard sizes”> You can then select the paper size. * The setting for drawer[cassette] No.3 and No.4 will only be available when the optional Paper Feeder is installed on your copier. | A3 A4 A4R A5R B4 B5 B5R Folio 11 x 17 8 1/2 x 14 11 x 8 1/2 8 1/2 x 11 5 1/2 x 8 1/2 8 1/2 x 13 8K 16K | --- | |

Section 7 COPIER MANAGEMENT FUNCTIONS

| Default setting | Description | Available settings | Factory setting | Reference page | | | | | | | | | |
|---|---|--|-----------------|-----------------|----------------------|---|---|----------------|---|---|--|----------------|--------|
| Paper type (drawer[cassette] No.1 - No. 4) | Sets and then displays the type of paper that is loaded in drawers[cassettes] No.1 through No.4. * The setting for drawer[cassette] No.3 and No.4 will only be available when the optional Paper Feeder is installed on your copier. | Plain Preprinted Recycled Letterhead Color [Colour] Prepunched Rough Bond High quality Vellum Custom 1 – Custom 8 | Plain | 7-44 | | | | | | | | | |
| Multi-bypass tray settings display ON/OFF | Turn this setting ON if you want the “Bypass setting” screen to be displayed whenever the “Bypass” key is touched in the “Basic” tab. | On / Off | Off | 7-45 | | | | | | | | | |
| Custom paper type for 2-sided copying | Sets whether or not each custom paper type (custom 1 – custom 8) will be available for use in 2-sided copying. | On / Off | On | 7-46 | | | | | | | | | |
| Special paper action setting | <p>When copying onto prepunched, preprinted or letterhead paper, and performing both 1-sided copying and 2-sided copying from the same drawer[cassette], the positioning of the holes in relation to the copied image may be different for each copy or the front and rear images of 2-sided copies may be copied onto the opposites sides of the paper. If you select “Adj. print Direction”, both 1-sided and 2-sided copies will be created with the same orientation.</p> <p>Example: Set the paper as shown in the illustration</p> <div style="text-align: center;">  Drawer[Cassette] </div> <table border="1" style="margin: 10px auto; border-collapse: collapse;"> <thead> <tr> <th style="text-align: center;">Setting</th> <th style="text-align: center;">1-sided copying</th> <th style="text-align: center;">2-sided copying</th> </tr> </thead> <tbody> <tr> <td style="text-align: center;">Adj. print Direction</td> <td style="text-align: center;"></td> <td style="text-align: center;"></td> </tr> <tr> <td style="text-align: center;">Speed Priority</td> <td style="text-align: center;"></td> <td style="text-align: center;"></td> </tr> </tbody> </table> <p>* When “Adj. print Direction” is selected, the speed of 1-sided copying will be somewhat slower than normal. * When making copies with “Adj. print Direction” selected, set the paper as shown in illustration (A) and with the first image being copied set face-down. (If the optional Built-in Finisher is installed on your copier, set the paper as shown in illustration (B) and with the first image being copied set face-down.)</p> <div style="text-align: center; margin: 10px 0;">  </div> <p>* If the optional Document Finisher or Built-in Finisher is installed on your copier and you have selected either the Staple mode or the Hole Punch mode, the direction that the copy image is created in may not conform to the desired position of the staples or holes.</p> | Setting | 1-sided copying | 2-sided copying | Adj. print Direction |  |  | Speed Priority |  |  | Adj. print Direction / Speed Priority | Speed Priority | 7-46-1 |
| Setting | 1-sided copying | 2-sided copying | | | | | | | | | | | |
| Adj. print Direction |  |  | | | | | | | | | | | |
| Speed Priority |  |  | | | | | | | | | | | |

Section 7 COPIER MANAGEMENT FUNCTIONS

| Default setting | Description | Available settings | Factory setting | Reference page |
|------------------------|--|--|-----------------|----------------|
| Auto sleep time | <p>Sets the amount of time that will elapse before the auto sleep function engages and turns the copier OFF (O) if no operation is performed on the copier during that time.</p> <p>* It is recommended that you try to set a longer time interval before the auto sleep function engages if you use the copier frequently, and to a shorter time if there are long intervals between use.</p> <p>* For more detailed information on the auto sleep function, see page 4-11.</p> | 1, 5, 15, 30, 45, 60, 90, 120, 180, 240 (minutes) | 60 (minutes) | 7-47 |
| Auto low power time | <p>Sets the amount of time that will elapse before the Low Power mode is automatically activated if no operation is performed on the copier during that time.</p> <p>* For more detailed information on the Low power mode, see page 4-11.</p> | 1, 5, 15, 30, 45, 60, 90, 120, 180, 240 (minutes) | 15 (minutes) | 7-48 |
| Copy eject location | <p>Sets the location for the ejection of finished copies.</p> <p>* This setting will only be displayed when the optional Document Finisher, Built-in Finisher or Job Separator is installed on your copier.</p> <p>* The available location for ejection will differ depending upon the optional equipment that is installed on your copier.</p> | Inner tray Job separator Finisher tray Finisher main tray Finisher sub tray | Inner tray | 7-49 |
| Fax eject location | <p>Sets the location for the ejection of received faxes.</p> <p>* This setting will only be displayed when the optional Fax Kit and Document Finisher (or the Built-in Finisher or Job Separator) are installed on your copier.</p> <p>* The available location for ejection will differ depending upon the optional equipment that is installed on your copier.</p> | Inner tray Job separator Finisher tray Finisher main tray Finisher sub tray Mailbox 1 | Inner tray | 7-50 |
| Default operation mode | <p>Sets which operation mode, the copy operation mode or the fax operation mode, will be selected when the power is turned on to the copier.</p> | Copy mode FAX mode | Copy mode | 7-51 |

Section 7 COPIER MANAGEMENT FUNCTIONS

| Default setting | Description | Available settings | Factory setting | Reference page |
|---------------------------------|---|--|---|----------------|
| Touch panel sound ON/OFF | Sets whether or not the touch panel will emit a “beep” sound each time a key is touched. | On / Off | On | 7-52 |
| Silent mode ON/OFF | The copier can be switched to a silent mode, which shortens the length of time that the laser data writing motor continues to spin after each copy job is finished. Turn the silent mode ON if the noise of the motor bothers you in any way. | On / Off | Off | 7-53 |
| Day & time | Sets the current date and time. | Year: 2001-2049 Month: 1 – 12 Day: 1 – 31 Time: 00:00 – 23:59 | Year: 2001 Month: 01 Day: 01 Time: 00:00 | 7-54 |
| Time difference | Sets the time difference from the world standard time (GMT). | +12:00 – -12:00 | 00:00 | 7-55 |
| Changing the management code | Changes the management code that is used by the copy manager. IMPORTANT: If you change the management code from its factory default, be sure to keep some sort of record of the new management code. If, for any reason, you forget the registered management code, you will need to contact your service representative. | 0000 – 9999 | 30 cpm copiers: 3000 40 cpm copiers: 4000 50 cpm copiers: 5000 | 7-56 |
| Auto sleep ON/OFF | Sets whether or not to have the auto sleep function automatically engage and turn the copier OFF (O) if no operation is performed on the copier for a designated amount of time. * If auto sleep interferes with your copying operations, turn this function OFF. However, it is recommended that you try to set a longer time interval until auto sleep engages before you actually turn it OFF. * For more detailed information on turn the auto sleep function, see page 4-11. | On / Off | On | 7-57 |
| Changing the energy-saving mode | Changes the energy-saving mode that will be entered into when the [Energy Saver] key is pressed. (See “5. Energy-saving modes” on page 4-11 for more information.) * This setting is displayed when the optional Printer Kit or Printer/Scanner Kit is installed. If you are using a standard copier, or if the optional Fax Kit is installed in your copier, you can press the [Energy Saver] key to engage the Low power mode. | Low power mode Sleep mode | Low power mode | 7-58 |

Section 7 COPIER MANAGEMENT FUNCTIONS

(2) Accessing the machine default settings

Perform the following procedure when you want to access the screens for each of the various machine default settings.

- 1 With the content of the “Basic” tab displayed, press the [Default Setting/Counter] key. The “Default setting” screen will be displayed.

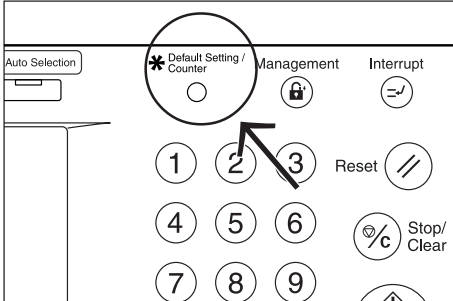

- 2 Touch the “Machine default” key on the left side of the touch panel.

Inch specifications

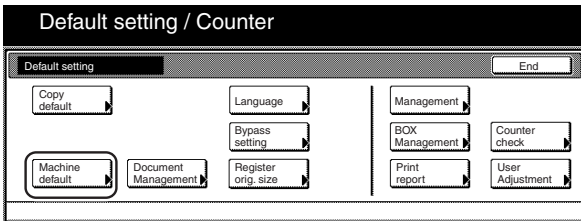

Metric specifications

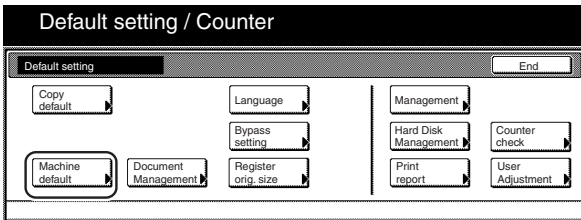

- 3 Use the keypad to enter the 4-digit management code. The factory default setting for 30 cpm copiers is “3000”, for 40 cpm copiers is “4000” and for 50 cpm copiers is “5000”.

Inch specifications

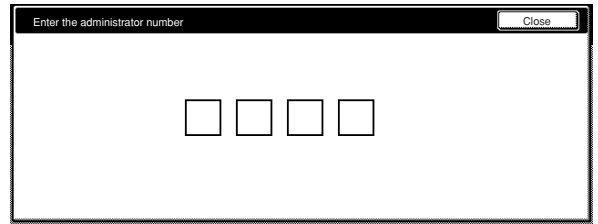

Metric specifications

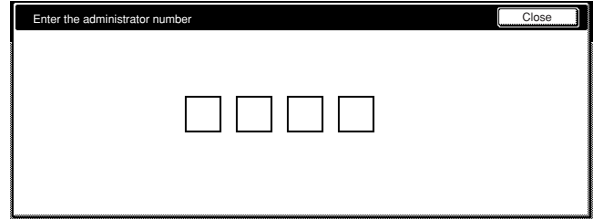

- 4 If the entered code matched the registered one, the “Machine default” screen will be displayed.

Inch specifications

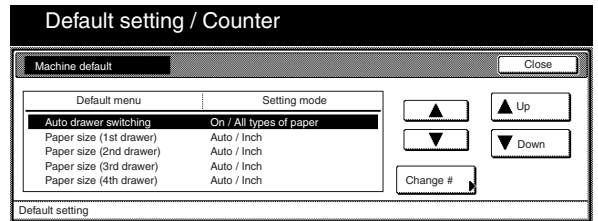

Metric specifications

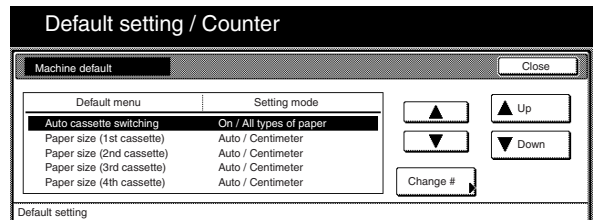

NOTES

- It is possible for you to change the 4-digit management code. (See “Changing the management code” on page 7-56.)
- Refer to the desired procedure(s) explained under “(3) Making machine default settings” and perform the corresponding setting(s).

(3) Making machine default settings

Perform the following procedure that corresponds to the desired setting.

● **Auto drawer[cassette] switching ON/OFF**

Perform the following procedure to turn automatic drawer[cassette] switching ON or OFF, as desired.

- 1 Display the "Machine default" screen. (See "(2) Accessing the machine default settings" on page 7-41.)

Inch specifications

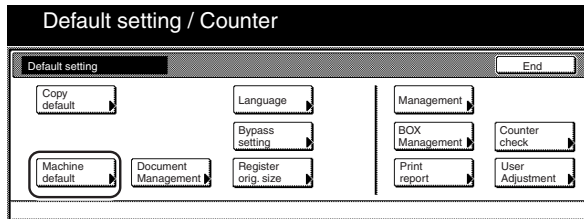

Metric specifications

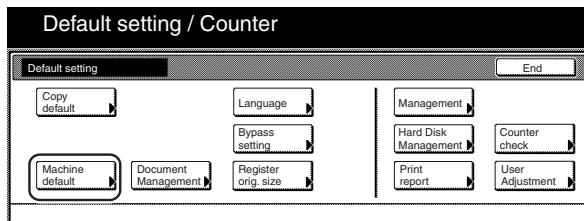

- 2 Select "Auto drawer switching" ["Auto cassette switching"] in the settings list on the left side of the touch panel and then touch the "Change #" key. The "Auto drawer switching" ["Auto cassette switching"] screen will be displayed.

Inch specifications

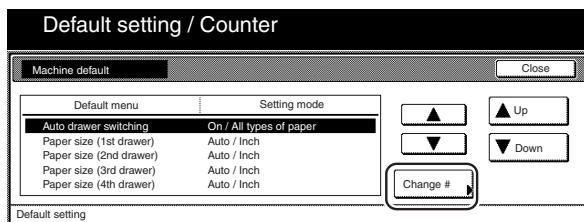

Metric specifications

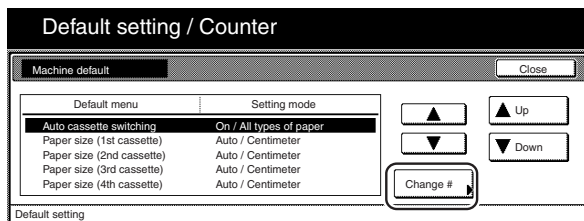

- 3 Touch the "On" key to automatic drawer[cassette] switching ON.

Inch specifications

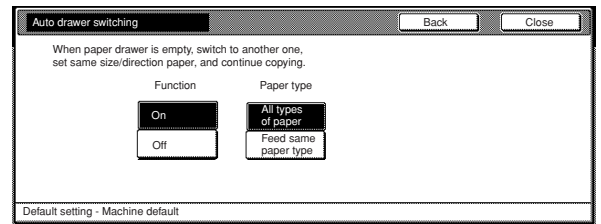

Metric specifications

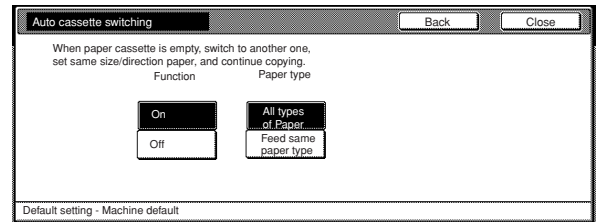

- 4 In order to prevent a drawer[cassette] that holds a different type of paper from being switched to when the automatic drawer[cassette] switching function is turned ON, touch the "Feed same paper type" key under "Paper type".

NOTE

If you want to quit the displayed setting without changing it, touch the "Back" key. The touch panel will return to the screen in step 2.

- 5 Touch the "Close" key. The touch panel will return to the screen in step 2.

- 6 Touch the "Close" key once again. The touch panel will return to the "Default setting" screen.

- 7 Touch the "End" key. The touch panel will return to the contents of the "Basic" tab.

Section 7 COPIER MANAGEMENT FUNCTIONS

● Paper size (drawer[cassette] No.1 – No.4)

Perform the following procedure to set the size of paper that is loaded in drawer[cassette] No.1 through No.4.

- 1 Display the “Machine default” screen.
(See “(2) Accessing the machine default settings” on page 7-41.)

Inch specifications

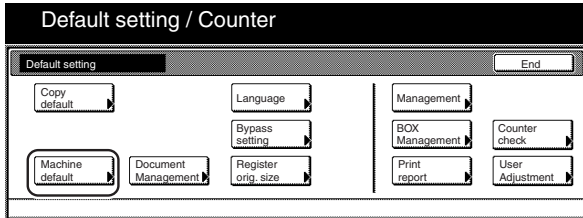

Metric specifications

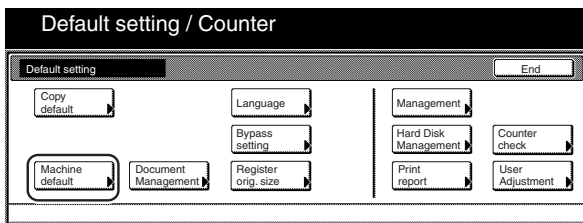

- 2 Select one of the “Paper size” settings (“1st drawer[cassette]” through “4th drawer[cassette]”) in the settings list on the left side of the touch panel and then touch the “Change #” key.
The screen to set the paper size for that drawer[cassette] will be displayed.

Inch specifications

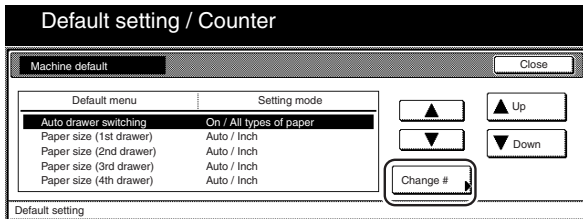

Metric specifications

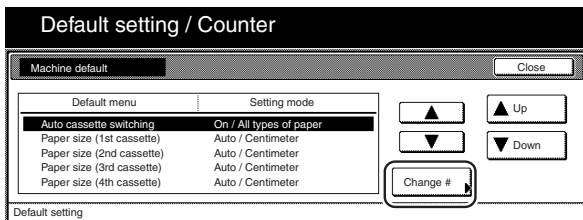

- 3 If you select “Auto Detection” (automatic size detection) here, select the desired unit of measure (“Centimeter” or “Inch”) as well.

If you select “Standard sizes” (standard paper size) here, simply touch the key that corresponds to the size of paper that is loaded in that drawer[cassette].

Inch specifications

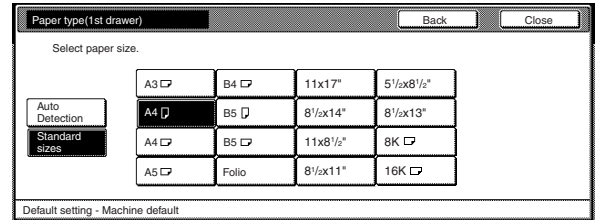

Metric specifications

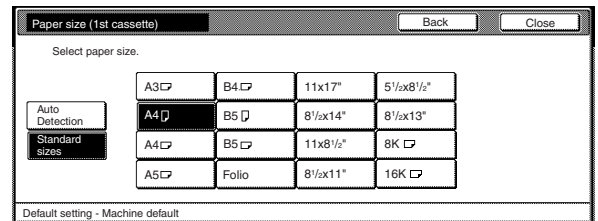

NOTES

- If you want to quit the displayed setting without changing it, touch the “Back” key. The touch panel will return to the screen in step 2.
 - The setting for drawer[cassette] No.3 and No.4 will only be available when the optional Paper Feeder is installed on your copier.
- 4 Touch the “Close” key. The touch panel will return to the screen in step 2.
 - 5 Touch the “Close” key once again. The touch panel will return to the “Default setting” screen.
 - 6 Touch the “End” key. The touch panel will return to the contents of the “Basic” tab.

● Paper type (drawer[cassette] No.1 - No. 4)

Perform the following procedure to set the type of paper that is loaded in drawers[cassettes] No.1 through No.4.

- 1 Display the "Machine default" screen. (See "(2) Accessing the machine default settings" on page 7-41.)

Inch specifications

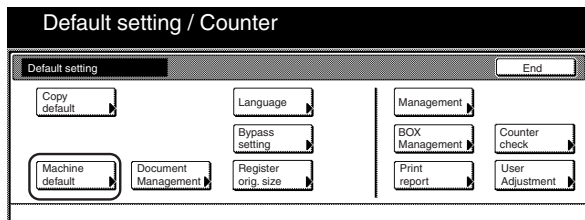

Metric specifications

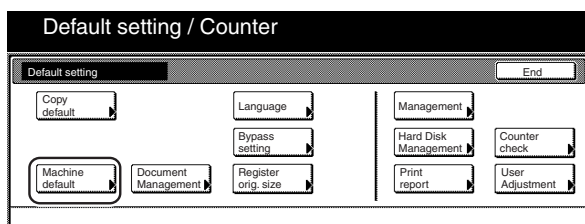

- 2 Select one of the "Paper type" settings ("1st drawer[cassette]" through "4th drawer[cassette]") in the settings list on the left side of the touch panel and then touch the "Change #" key. The screen to set the paper type for that drawer[cassette] will be displayed.

Inch specifications

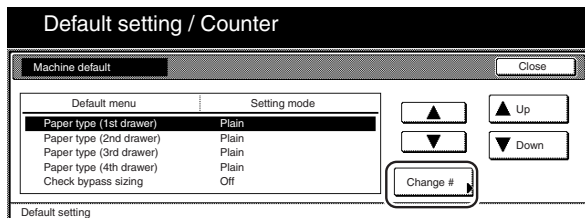

Metric specifications

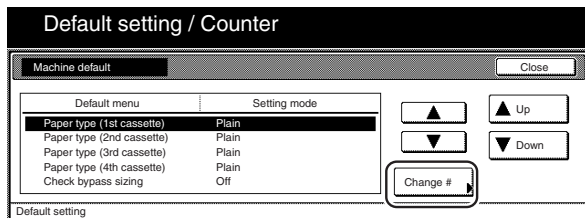

- 3 Touch the key that corresponds to the type of paper that is loaded in that drawer[cassette].

Inch specifications

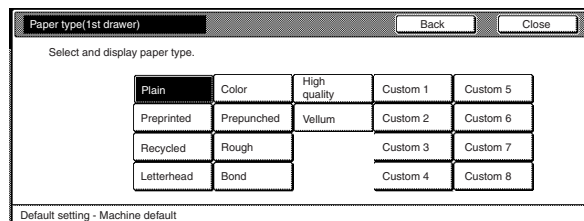

Metric specifications

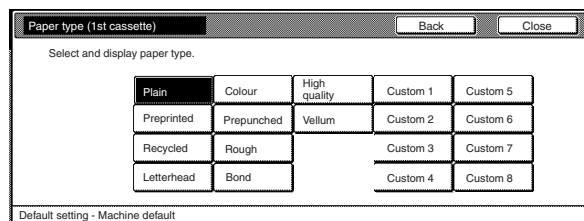

NOTES

- If you want to quit the displayed setting without changing it, touch the "Back" key. The touch panel will return to the screen in step 2.
- The setting for drawer[cassette] No.3 and No.4 will only be available when the optional Paper Feeder is installed on your copier.

- 4 Touch the "Close" key. The touch panel will return to the screen in step 2.

- 5 Touch the "Close" key once again. The touch panel will return to the "Default setting" screen.

- 6 Touch the "End" key. The touch panel will return to the contents of the "Basic" tab.

Section 7 COPIER MANAGEMENT FUNCTIONS

● Multi-bypass tray settings display ON/OFF

Perform the following procedure to have the “Bypass setting” screen appear whenever the “Bypass” key is pressed in the “Basic” tab.

- 1 Display the “Machine default” screen.
(See “(2) Accessing the machine default settings” on page 7-41.)

Inch specifications

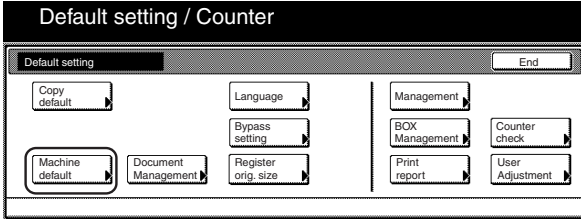

Metric specifications

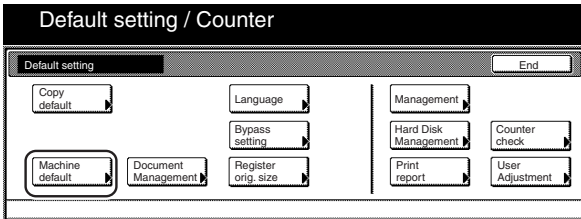

- 2 Select “Check bypass sizing” in the settings list on the left side of the touch panel and then touch the “Change #” key. The “Check bypass sizing” screen will be displayed.

Inch specifications

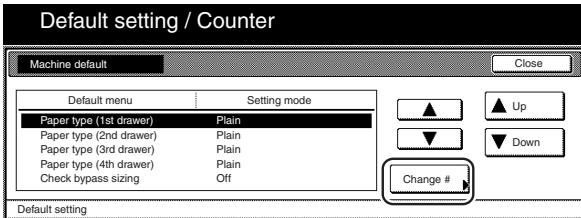

Metric specifications

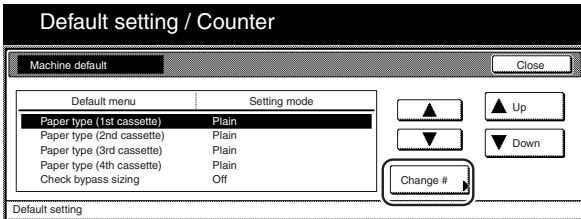

- 3 Touch the “On” key if you want to have the “Bypass setting” screen appear.

Inch specifications

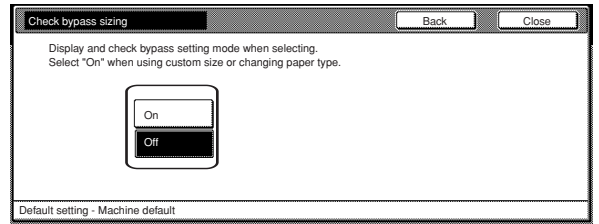

Metric specifications

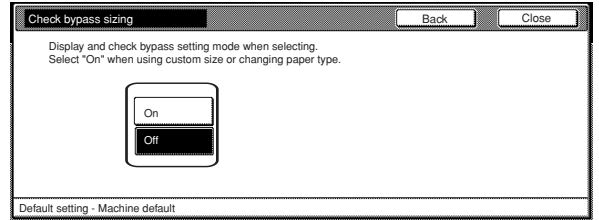

NOTE

If you want to quit the displayed setting without changing it, touch the “Back” key. The touch panel will return to the screen in step 2.

- 4 Touch the “Close” key. The touch panel will return to the screen in step 2.

- 5 Touch the “Close” key once again. The touch panel will return to the “Default setting” screen.

- 6 Touch the “End” key. The touch panel will return to the contents of the “Basic” tab.

● Custom paper type for 2-sided copying

Perform the following procedure to set whether or not each custom type of paper (custom 1 - custom 8) will be available for use in 2-sided copying.

- 1 Display the "Machine default" screen. (See "(2) Accessing the machine default settings" on page 7-41.)

Inch specifications

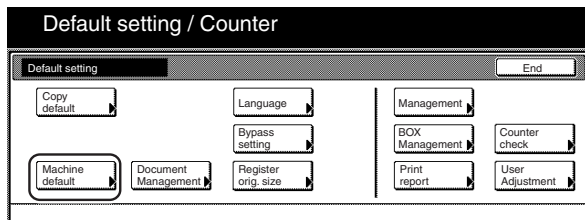

Metric specifications

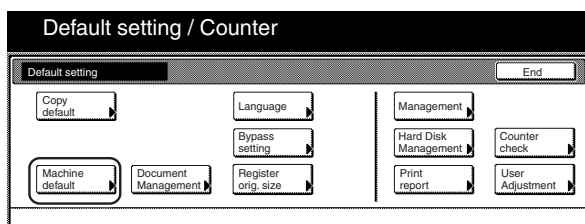

- 2 Select "Select paper type (2sided)" in the settings list on the left side of the touch panel and then touch the "Change #" key.

The "Select paper type (2sided)" screen will be displayed.

Inch specifications

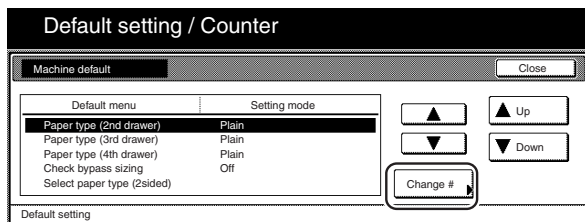

Metric specifications

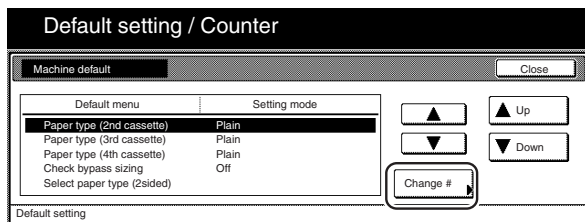

- 3 Select one of the "custom" paper type settings ("Custom 1" through "Custom 8") under the "Default menu" column on the left side of the touch panel and then touch the "Change #" key.

Inch specifications

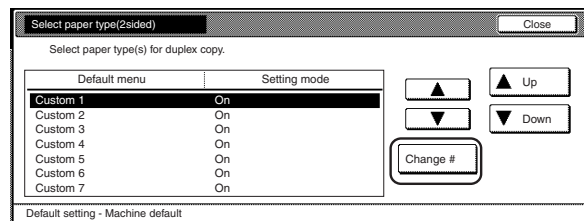

Metric specifications

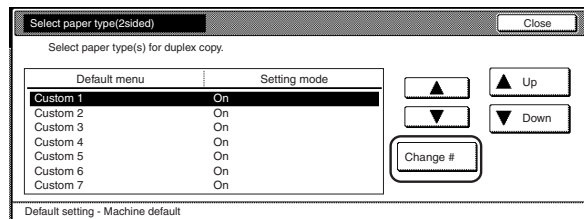

- 4 Touch the "Off" key if you do NOT want that custom paper type to be available for use in 2-sided copying.

Inch specifications

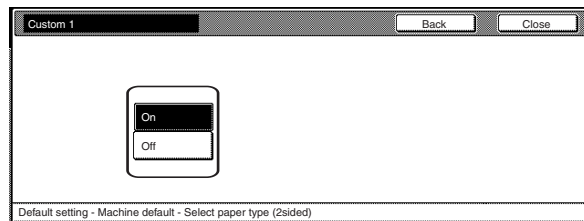

Metric specifications

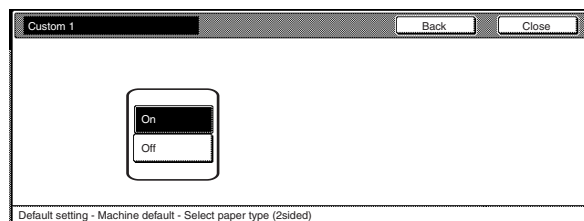

NOTE

If you want to quit the displayed setting without changing it, touch the "Back" key. The touch panel will return to the screen in step 3.

- 5 Touch the "Close" key. The touch panel will return to the screen in step 3.
- 6 Touch the "Close" key. The touch panel will return to the screen in step 2.
- 7 Touch the "Close" key. The touch panel will return to the "Default setting" screen.
- 8 Touch the "End" key. The touch panel will return to the contents of the "Basic" tab.

Section 7 COPIER MANAGEMENT FUNCTIONS

● Special paper action setting

When copying onto prepunched, preprinted or letterhead paper, and performing both 1-sided copying and 2-sided copying from the same drawer[cassette], the positioning of the holes in relation to the copied image may be different for each copy or the front and rear images of 2-sided copies may be copied onto the opposites sides of the paper. If you select "Adj. print Direction", both 1-sided and 2-sided copies will be created with the same orientation.

- 1 Display the "Machine default" screen.
(See "(2) Accessing the machine default settings" on page 7-41.)

Inch specifications

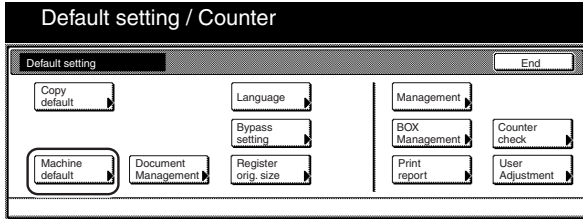

Metric specifications

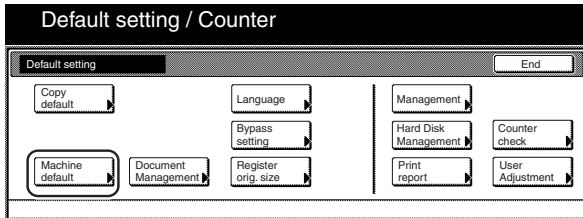

- 2 Select "Special paper action mode" ["Specif. paper action mode"] in the settings list on the left side of the touch panel and then touch the "Change #" key.

The "Special paper action mode" ["Specif. paper action mode"] screen will be displayed.

Inch specifications

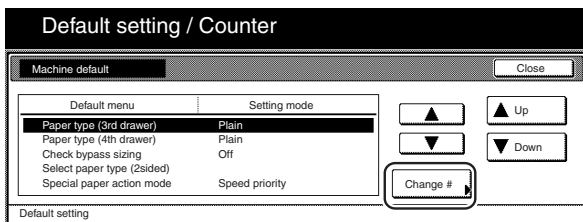

Metric specifications

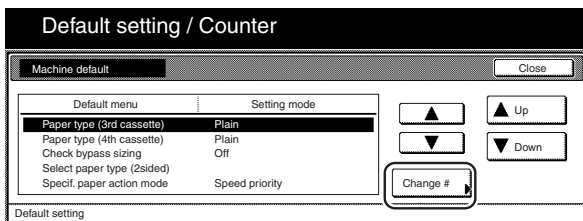

- 3 Select "Adj. print Direction".

Inch specifications

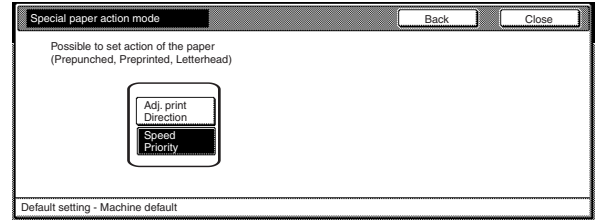

Metric specifications

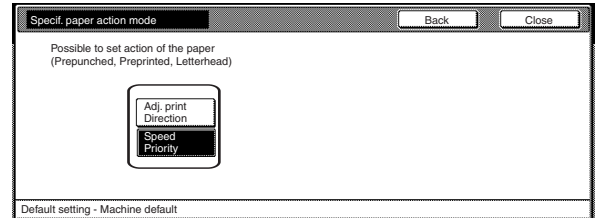

NOTES

- When "Adj. print Direction" is selected, the speed of 1-sided copying will be somewhat slower than normal.
- If you want to quit the displayed setting without changing it, touch the "Back" key. The touch panel will return to the screen in step 2.

- 4 Touch the "Close" key. The touch panel will return to the screen in step 2.

- 5 Touch the "Close" key once again. The touch panel will return to the "Default setting" screen.

- 6 Touch the "End" key. The touch panel will return to the contents of the "Basic" tab.

● Auto sleep time

Perform the following procedure to set the amount of time that will elapse before the auto sleep function engages and turns the copier OFF (O) if no operation has been performed on the copier during that time.

- 1 Display the "Machine default" screen. (See "(2) Accessing the machine default settings" on page 7-41.)

Inch specifications

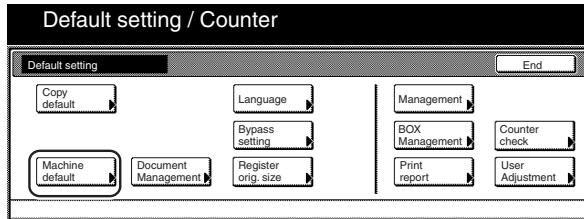

Metric specifications

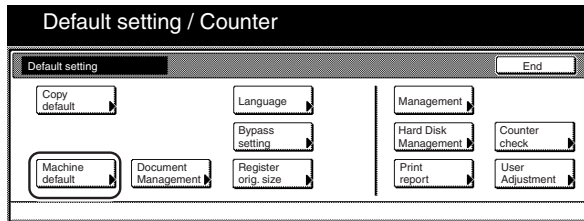

- 2 Select "Sleep mode changing time" in the settings list on the left side of the touch panel and then touch the "Change #" key.

The "Sleep mode changing time" screen will be displayed.

Inch specifications

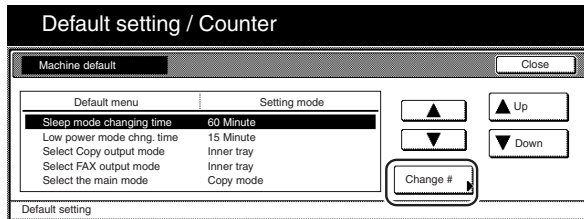

Metric specifications

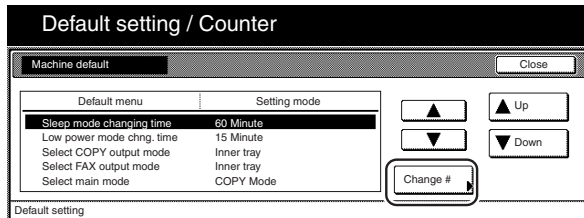

- 3 Touch the "+" key or the "-" key to change the displayed time to the desired setting (between 1 minutes and 240 minutes).

Inch specifications

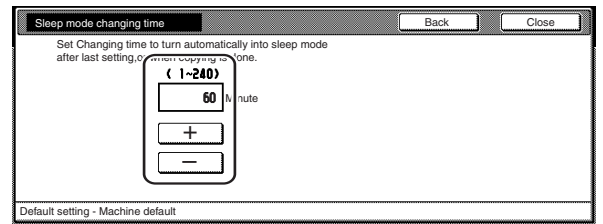

Metric specifications

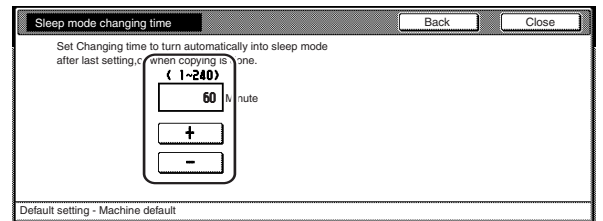

NOTES

- The setting can be made to 1 minute, 5 minutes, 15 minutes, 30 minutes, 45 minutes, 60 minutes, 90 minutes, 120 minutes, 180 minutes or 240 minutes.
- It is recommended that you try to set a longer time interval before the auto sleep function engages if you use the copier frequently, and to a shorter time if there are long intervals between use.
- If you want to quit the displayed setting without changing it, touch the "Back" key. The touch panel will return to the screen in step 2.

- 4 Touch the "Close" key. The touch panel will return to the screen in step 2.

- 5 Touch the "Close" key once again. The touch panel will return to the "Default setting" screen.

- 6 Touch the "End" key. The touch panel will return to the contents of the "Basic" tab.

Section 7 COPIER MANAGEMENT FUNCTIONS

● Auto low power time

Perform the following procedure to set the amount of time that will elapse before the auto low power function automatically engages and puts the copier in the Low power mode if no operation has been performed on the copier during that time.

- 1 Display the "Machine default" screen.
(See "(2) Accessing the machine default settings" on page 7-41.)

Inch specifications

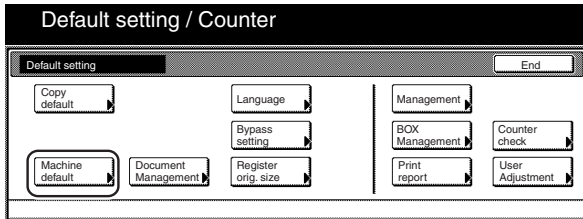

Metric specifications

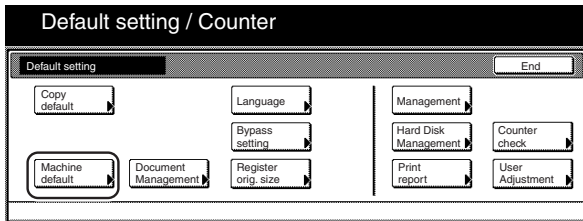

- 2 Select "Low power mode chng. time" in the settings list on the left side of the touch panel and then touch the "Change #" key.

The "Auto preheat time" screen will be displayed.

Inch specifications

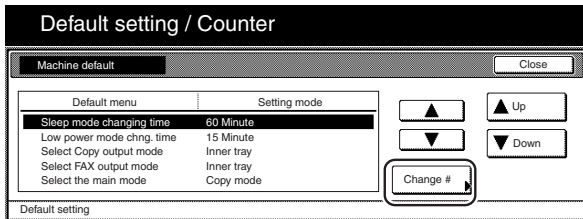

Metric specifications

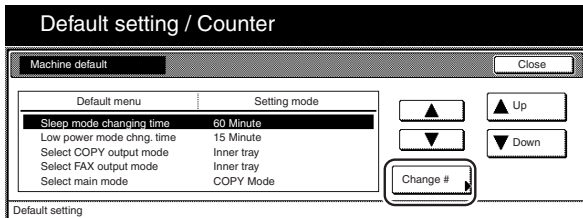

- 3 Touch the "+" key or the "-" key to change the displayed time to that desired (any available setting between 1 minute and 240 minutes).

Inch specifications

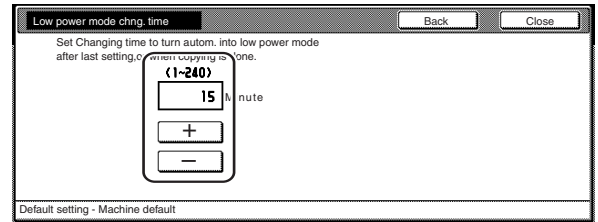

Metric specifications

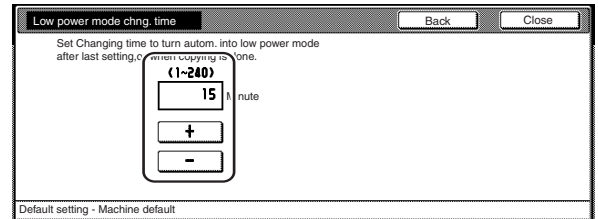

NOTES

- The setting can be made to 1 minute, 5 minutes, 15 minutes, 30 minutes, 45 minutes, 60 minutes, 90 minutes, 120 minutes, 180 minutes or 240 minutes.
- If you want to quit the displayed setting without changing it, touch the "Back" key. The touch panel will return to the screen in step 2.

- 4 Touch the "Close" key. The touch panel will return to the screen in step 2.

- 5 Touch the "Close" key once again. The touch panel will return to the "Default setting" screen.

- 6 Touch the "End" key. The touch panel will return to the contents of the "Basic" tab.

● Copy eject location

Perform the following procedure to set where finished copies will be ejected.

NOTE

This setting will only be displayed when the optional Document Finisher, Built-in Finisher or Job Separator is installed on your copier.

- 1 Display the "Machine default" screen. (See "(2) Accessing the machine default settings" on page 7-41.)

Inch specifications

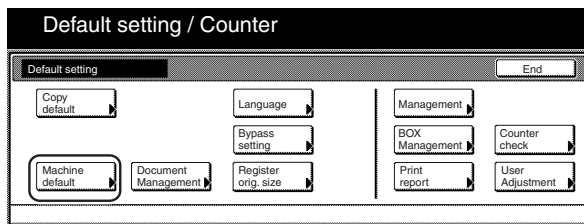

Metric specifications

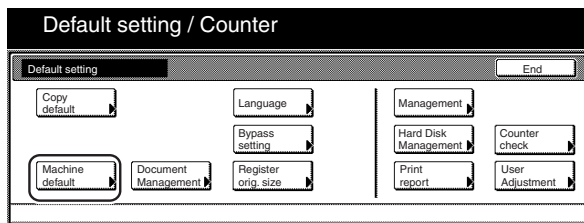

- 2 Select "Select Copy output mode" in the settings list on the left side of the touch panel and then touch the "Change #" key.

The "Select Copy output mode" screen will be displayed.

Inch specifications

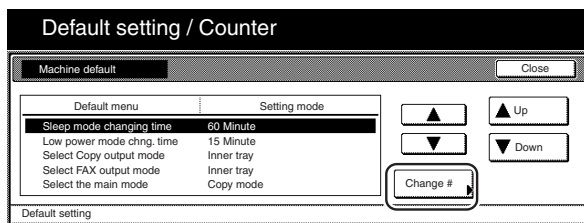

Metric specifications

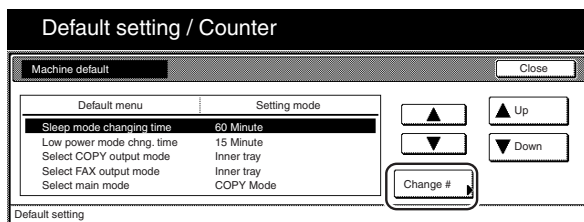

- 3 Touch the key that corresponds to the desired location.

Inch specifications

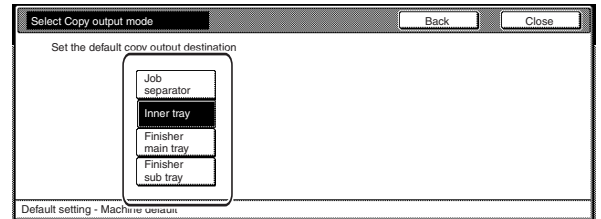

Metric specifications

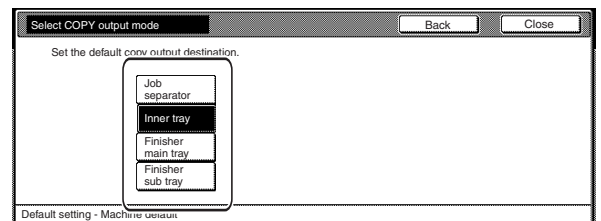

NOTES

- The available location for ejection will differ depending upon the optional equipment that is installed on your copier.
- If you want to quit the displayed setting without changing it, touch the "Back" key. The touch panel will return to the screen in step 2.

- 4 Touch the "Close" key. The touch panel will return to the screen in step 2.

- 5 Touch the "Close" key once again. The touch panel will return to the "Default setting" screen.

- 6 Touch the "End" key. The touch panel will return to the contents of the "Basic" tab.

Section 7 COPIER MANAGEMENT FUNCTIONS

● Fax eject location

Perform the following procedure to set where incoming faxes will be ejected.

NOTE

This setting will only be displayed when the optional Fax Kit and Document Finisher (or the Built-in Finisher or Job Separator) are installed on your copier.

- 1 Display the "Machine default" screen. (See "(2) Accessing the machine default settings" on page 7-41.)

Inch specifications

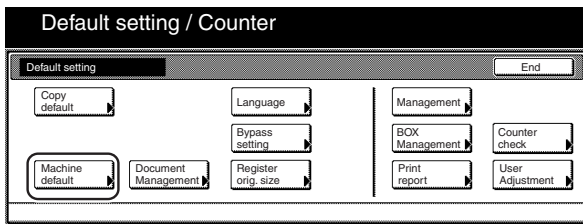

Metric specifications

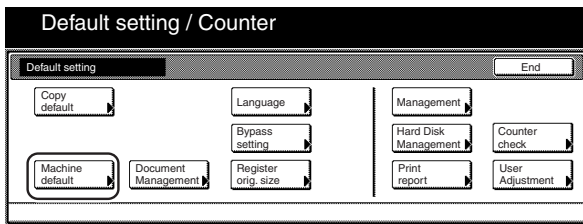

- 2 Select "Select FAX output mode" in the settings list on the left side of the touch panel and then touch the "Change #" key. The "Select FAX output mode" screen will be displayed.

Inch specifications

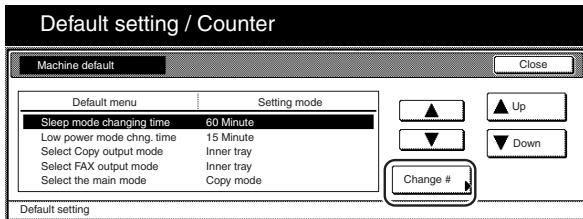

Metric specifications

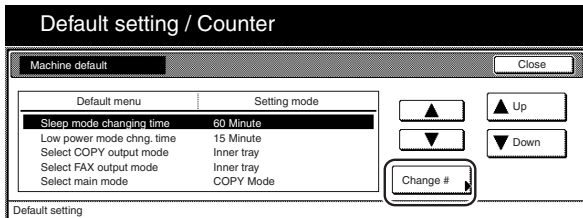

- 3 Touch the key that corresponds to the desired location.

Inch specifications

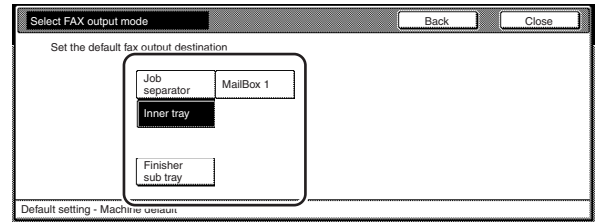

Metric specifications

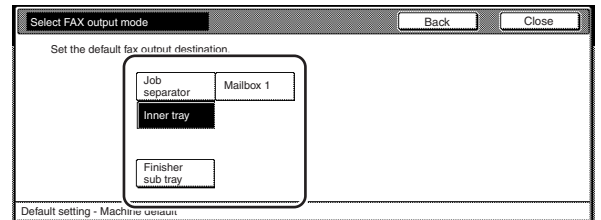

NOTES

- The available location for ejection will differ depending upon the optional equipment that is installed on your copier.
- If you want to quit the displayed setting without changing it, touch the "Back" key. The touch panel will return to the screen in step 2.

- 4 Touch the "Close" key. The touch panel will return to the screen in step 2.

- 5 Touch the "Close" key once again. The touch panel will return to the "Default setting" screen.

- 6 Touch the "End" key. The touch panel will return to the contents of the "Basic" tab.

● **Default operation mode**

Perform the following procedure to set whether the display that appears after power is turned on to the copier will be the one for the copy operation mode or for the fax operation mode.

NOTE

This setting is only available when the optional Fax Kit is installed in your copier.

- 1 Display the "Machine default" screen. (See "(2) Accessing the machine default settings" on page 7-41.)

Inch specifications

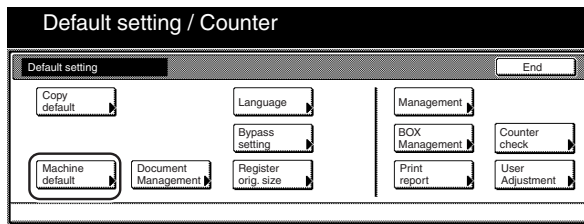

Metric specifications

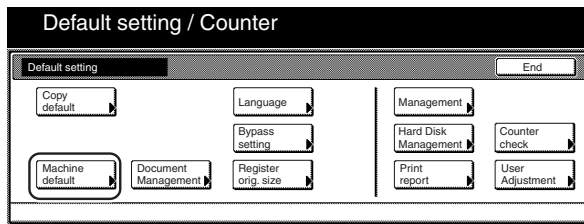

- 2 Select "Select the main mode" ["Select main mode"] in the settings list on the left side of the touch panel and then touch the "Change #" key. The "Select the main mode" ["Select main mode"] screen will be displayed.

Inch specifications

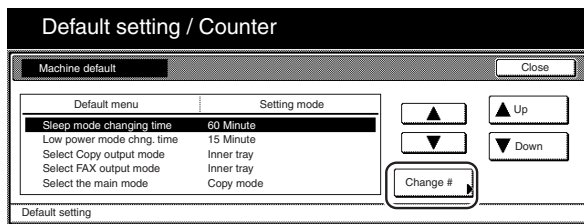

Metric specifications

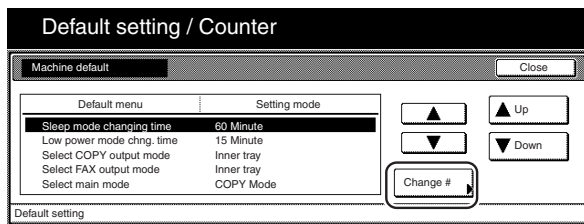

- 3 Select the "Copy mode" key or the "FAX mode" key, as appropriate.

Inch specifications

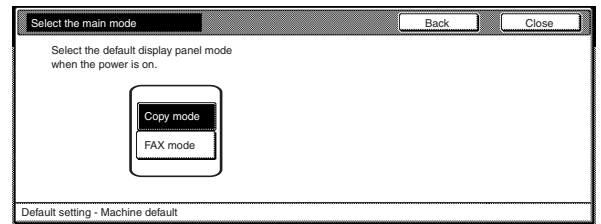

Metric specifications

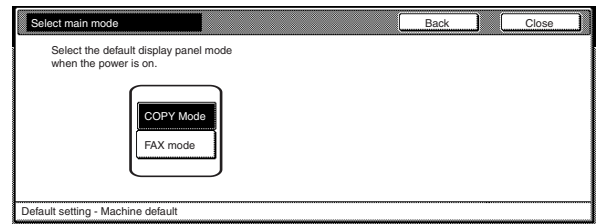

NOTE

If you want to quit the displayed setting without changing it, touch the "Back" key. The touch panel will return to the screen in step 2.

- 4 Touch the "Close" key. The touch panel will return to the screen in step 2.

- 5 Touch the "Close" key once again. The touch panel will return to the "Default setting" screen.

- 6 Touch the "End" key. The touch panel will return to the contents of the "Basic" tab.

Section 7 COPIER MANAGEMENT FUNCTIONS

● Touch panel sound ON/OFF

Perform the following procedure to set whether or not the touch panel will emit a “beep” sound each time a key is touched. Select “Off” if you want to turn the sound OFF.

- 1 Display the “Machine default” screen.
(See “(2) Accessing the machine default settings” on page 7-41.)

Inch specifications

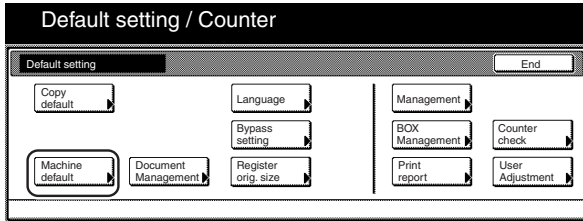

Metric specifications

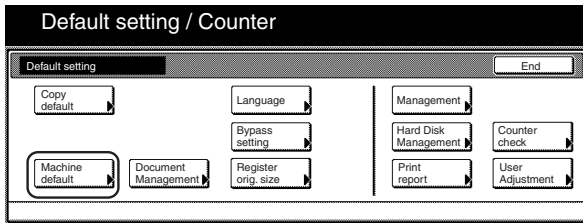

- 2 Select “Key sound ON/OFF” in the settings list on the left side of the touch panel and then touch the “Change #” key. The “Key sound ON/OFF” screen will be displayed.

Inch specifications

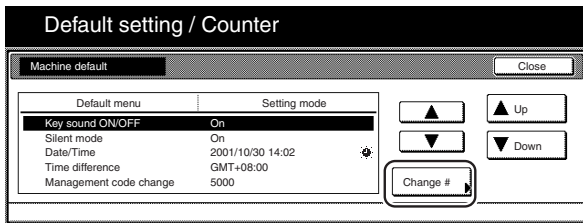

Metric specifications

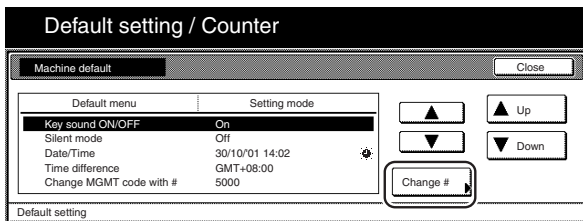

- 3 Touch the “On” key or the “Off” key to turn the sound on the touch panel ON or OFF, as desired.

Inch specifications

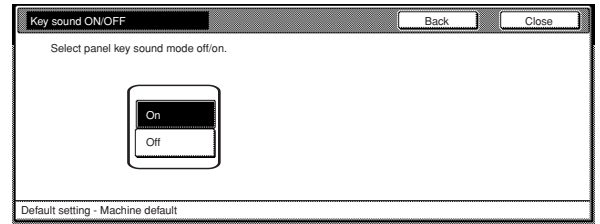

Metric specifications

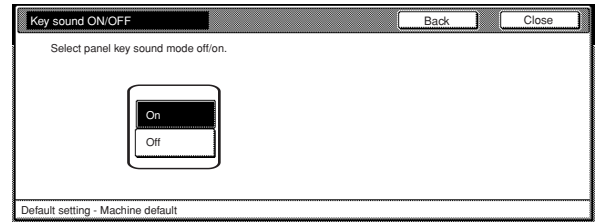

NOTE

If you want to quit the displayed setting without changing it, touch the “Back” key. The touch panel will return to the screen in step 2.

- 4 Touch the “Close” key. The touch panel will return to the screen in step 2.
- 5 Touch the “Close” key once again. The touch panel will return to the “Default setting” screen.
- 6 Touch the “End” key. The touch panel will return to the contents of the “Basic” tab.

● Silent mode ON/OFF

Perform the following procedure to set whether or not to use the silent mode which shortens the length of time that the laser data writing motor continues to spin after each copy job is finished. Turn the silent mode ON if the noise of the motor bothers you in any way.

- 1 Display the "Machine default" screen. (See "(2) Accessing the machine default settings" on page 7-41.)

Inch specifications

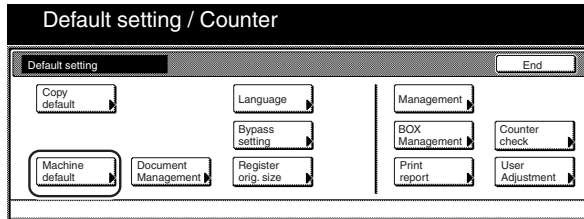

Metric specifications

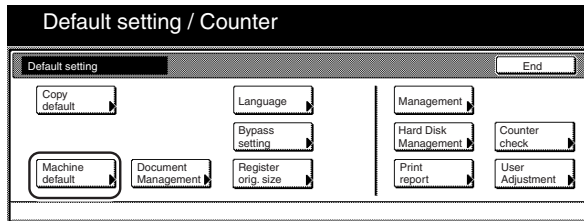

- 2 Select "Silent mode" in the settings list on the left side of the touch panel and then touch the "Change #" key. The "Silent mode" screen will be displayed.

Inch specifications

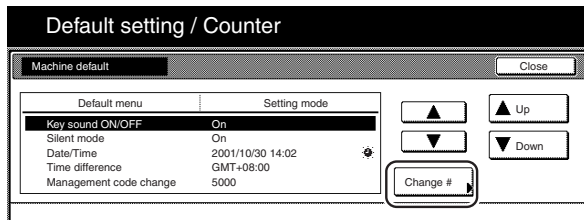

Metric specifications

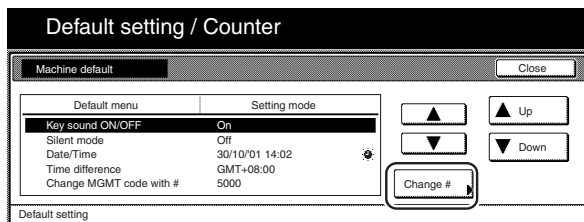

- 3 Touch the "On" key if you want to use the silent mode.

Inch specifications

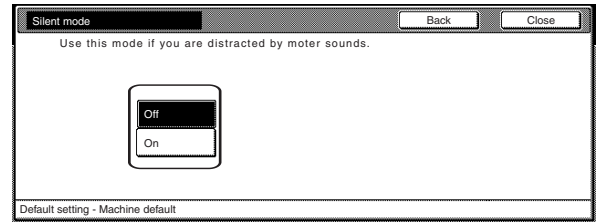

Metric specifications

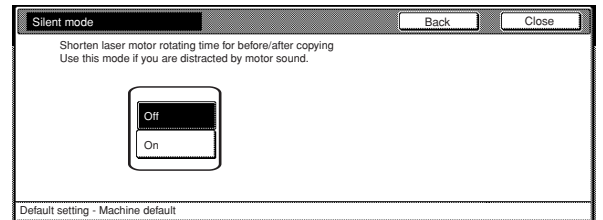

NOTE

If you want to quit the displayed setting without changing it, touch the "Back" key. The touch panel will return to the screen in step 2.

- 4 Touch the "Close" key. The touch panel will return to the screen in step 2.

- 5 Touch the "Close" key once again. The touch panel will return to the "Default setting" screen.

- 6 Touch the "End" key. The touch panel will return to the contents of the "Basic" tab.

Section 7 COPIER MANAGEMENT FUNCTIONS

● Day & time

Perform the following procedure to set the current date and time.

NOTE

BE SURE to perform the "Time difference" setting prior to setting the day and time.

- 1 Display the "Machine default" screen.
(See "(2) Accessing the machine default settings" on page 7-41.)

Inch specifications

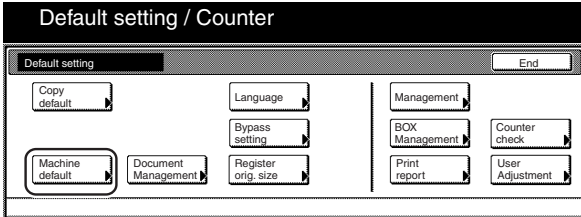

Metric specifications

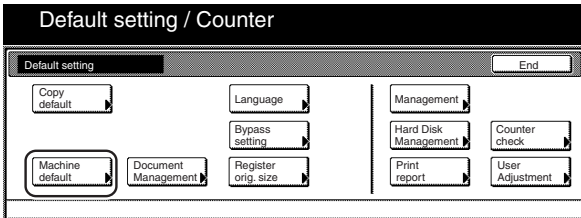

- 2 Select "Date/Time" in the settings list on the left side of the touch panel and then touch the "Change #" key. The "Date/Time" screen will be displayed.

Inch specifications

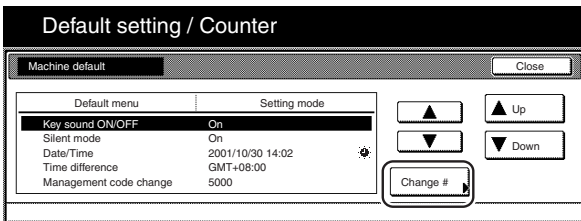

Metric specifications

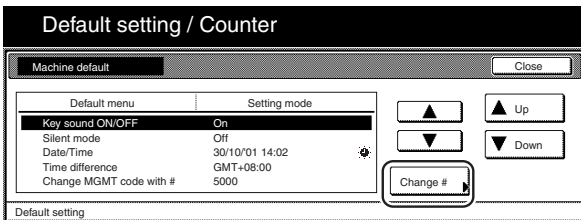

- 3 Touch the "+" key or the "-" key to change the displayed information for each field ("Year", "Month", "Day" and "Time") to the current time and date.
If you want the time to be automatically calculated for daylight savings time, touch the "On" key under "Summertime".

Inch specifications

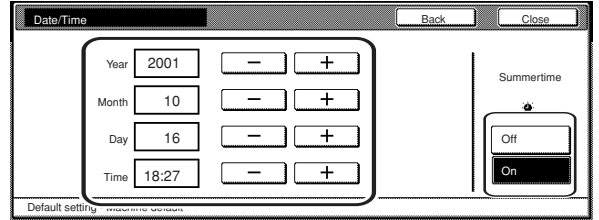

Metric specifications

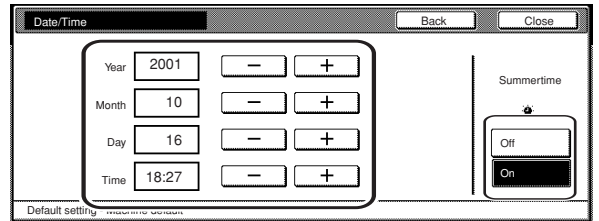

NOTE

If you want to quit the displayed setting without changing it, touch the "Back" key. The touch panel will return to the screen in step 2.

- 4 Touch the "Close" key. The touch panel will return to the screen in step 2.
- 5 Touch the "Close" key once again. The touch panel will return to the "Default setting" screen.
- 6 Touch the "End" key. The touch panel will return to the contents of the "Basic" tab.

● Time difference

Perform the following procedure to set a designated time difference from the world standard time (GMT).

- 1 Display the "Machine default" screen.
(See "(2) Accessing the machine default settings" on page 7-41.)

Inch specifications

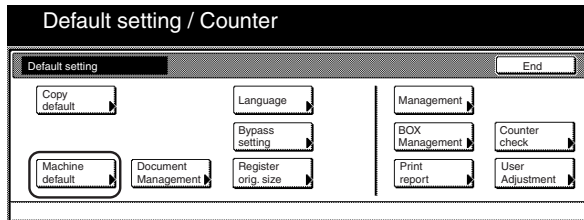

Metric specifications

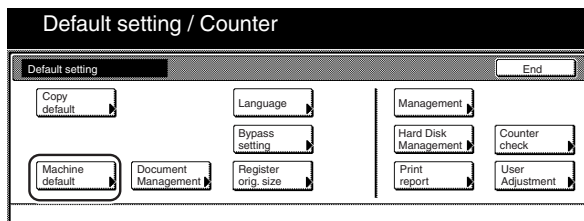

- 2 Select "Time difference" in the settings list on the left side of the touch panel and then touch the "Change #" key. The "Time difference" screen will be displayed.

Inch specifications

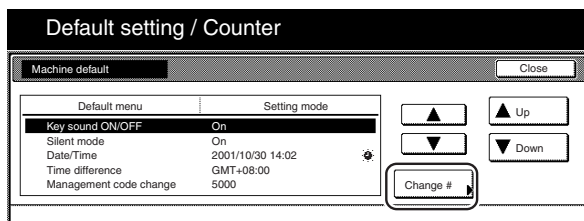

Metric specifications

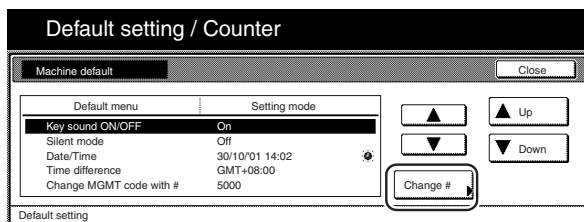

- 3 Touch the "+" key or the "-" key to change the displayed time difference to the desired setting.

Inch specifications

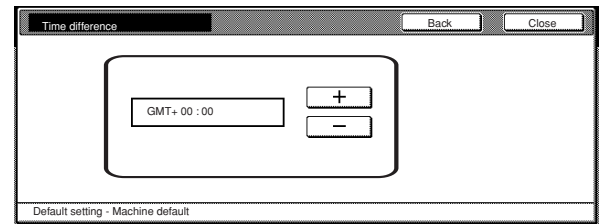

Metric specifications

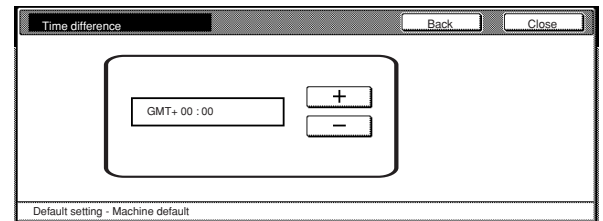

NOTE

If you want to quit the displayed setting without changing it, touch the "Back" key. The touch panel will return to the screen in step 2.

- 4 Touch the "Close" key. The touch panel will return to the screen in step 2.

- 5 Touch the "Close" key once again. The touch panel will return to the "Default setting" screen.

- 6 Touch the "End" key. The touch panel will return to the contents of the "Basic" tab.

Section 7 COPIER MANAGEMENT FUNCTIONS

● Changing the management code

Perform the following procedure to change the management code used by the copy manager.

IMPORTANT!

If you change the management code from its factory default, be sure to keep some sort of record of the new management code. If, for any reason, you forget the registered management code, you will need to contact your service representative.

- 1 Display the "Machine default" screen. (See "(2) Accessing the machine default settings" on page 7-41.)

Inch specifications

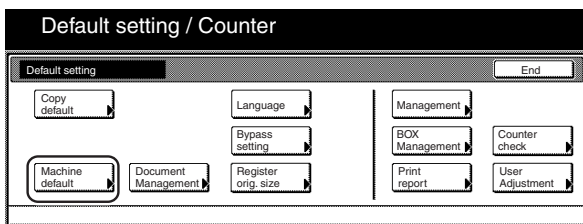

Metric specifications

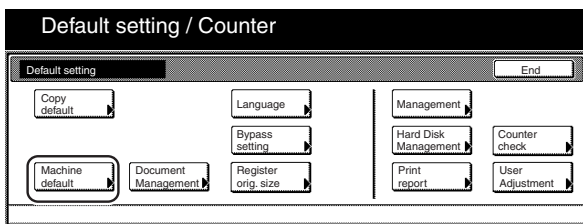

- 2 Select "Management code change" ["Change MGMT code with #"] in the settings list on the left side of the touch panel and then touch the "Change #" key. The "Management code change" ["Change MGMT code with #"] screen will be displayed.

Inch specifications

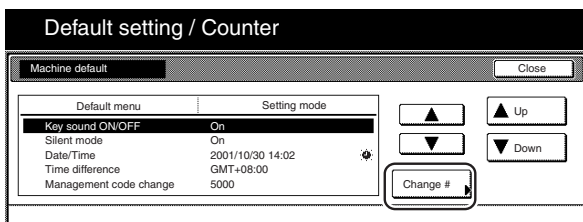

Metric specifications

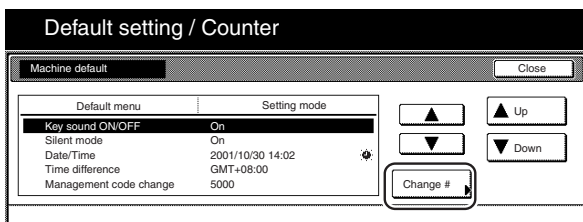

- 3 Use the keypad to enter a new 4-digit management code.

Inch specifications

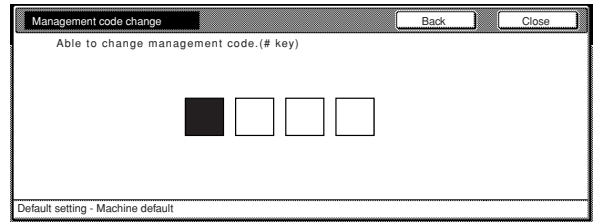

Metric specifications

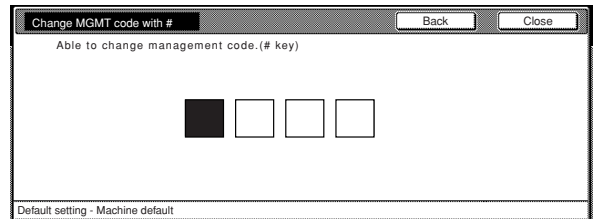

NOTE

If you want to quit the displayed setting without changing it, touch the "Back" key. The touch panel will return to the screen in step 2.

- 4 Touch the "Close" key. The touch panel will return to the screen in step 2.
- 5 Touch the "Close" key once again. The touch panel will return to the "Default setting" screen.
- 6 Touch the "End" key. The touch panel will return to the contents of the "Basic" tab.

● Auto sleep ON/OFF

Perform the following procedure to set whether or not to have the auto sleep function automatically engage and turn the copier OFF (O) if no operation is performed on the copier for a designated amount of time.

- 1 Display the "Machine default" screen. (See "(2) Accessing the machine default settings" on page 7-41.)

Inch specifications

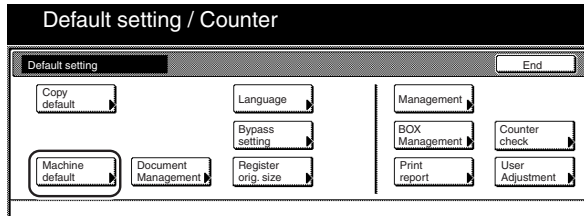

Metric specifications

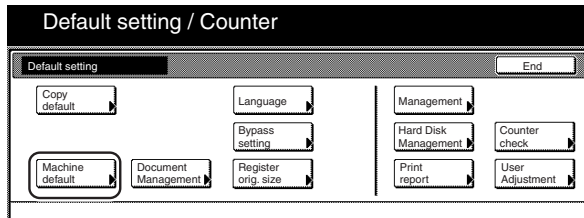

- 2 Select "Auto sleep" in the settings list on the left side of the touch panel and then touch the "Change #" key. The "Auto sleep" screen will be displayed.

Inch specifications

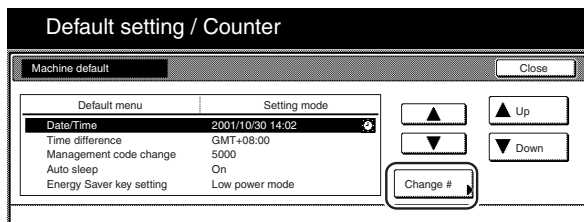

Metric specifications

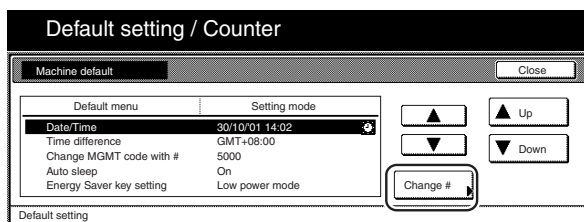

- 3 Touch the "On" key if you want to use the auto sleep function.

Inch specifications

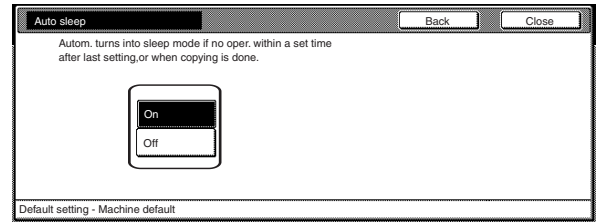

Metric specifications

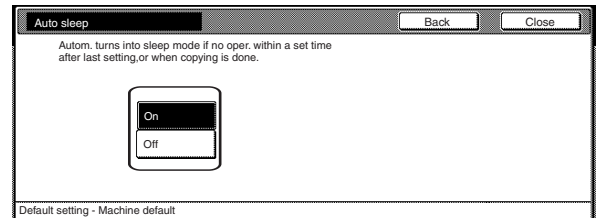

NOTES

- If auto sleep interferes with your copying operations, turn this function OFF. However, it is recommended that you try to set a longer time interval until auto sleep engages before you actually turn it OFF.
- If you want to quit the displayed setting without changing it, touch the "Back" key. The touch panel will return to the screen in step 2.

- 4 Touch the "Close" key. The touch panel will return to the screen in step 2.

- 5 Touch the "Close" key once again. The touch panel will return to the "Default setting" screen.

- 6 Touch the "End" key. The touch panel will return to the contents of the "Basic" tab.

Section 7 COPIER MANAGEMENT FUNCTIONS

● Changing the energy-saving mode

Perform the following procedure to change the energy-saving mode (the Low power mode or the Sleep mode) that will be entered into when the [Energy Saver] key is pressed.

- 1 Display the "Machine default" screen.
(See "(2) Accessing the machine default settings" on page 7-41.)

Inch specifications

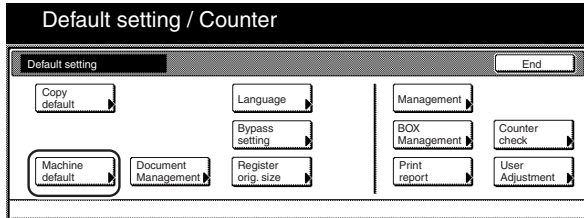

Metric specifications

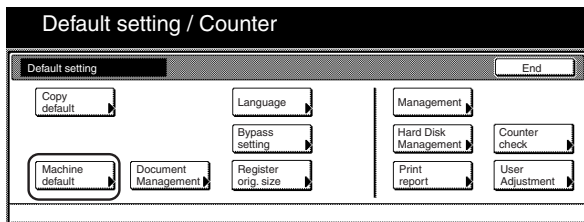

- 2 Select "Energy Saver key setting" in the settings list on the left side of the touch panel and then touch the "Change #" key.

The "Energy Saver key setting" screen will be displayed.

Inch specifications

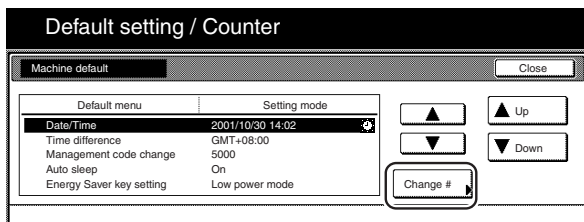

Metric specifications

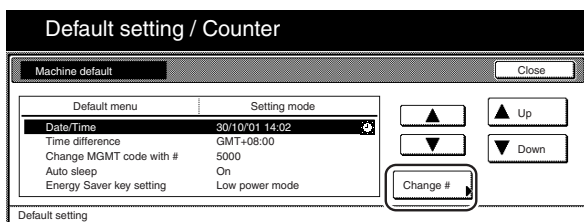

- 3 Touch the "Low power mode" key or the "Sleep mode" key, as desired.

Inch specifications

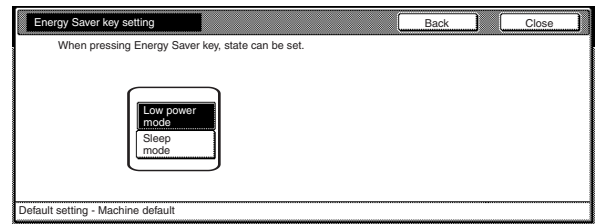

Metric specifications

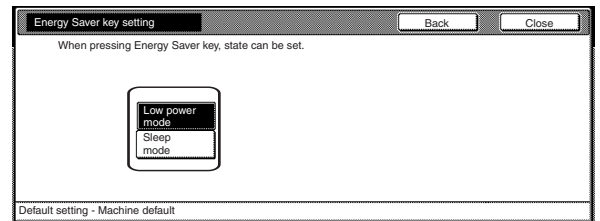

NOTE

If you want to quit the displayed setting without changing it, touch the "Back" key. The touch panel will return to the screen in step 2.

- 4 Touch the "Close" key. The touch panel will return to the screen in step 2.

- 5 Touch the "Close" key once again. The touch panel will return to the "Default setting" screen.

- 6 Touch the "End" key. The touch panel will return to the contents of the "Basic" tab.

(4) Copy default settings

The following table indicates the copy default settings available in this copier. Change any or all of the settings as desired in order to make the most effective use of your copier.

| Default setting | Description | Available settings | Factory setting | Reference page |
|--|--|--|----------------------|----------------|
| Exposure mode | Selects between auto exposure and manual exposure as the default copy exposure mode in the initial mode. | Manual / Auto | Manual | 7-63 |
| Exposure adjustment step | Changes the incremental step to be used during adjustment of the copy exposure. | 1 step / 0.5 step | 1 step | 7-64 |
| Original quality | Determines the default setting that will be used for the image quality in the initial mode. | Text+Photo / Text / Photo | Text+Photo | 7-65 |
| Eco print mode ON/OFF | Determines whether the Eco print mode will be the default setting in the initial mode. In this case, the amount of toner that is used to make the copies will be reduced, and images will be printed out relatively lighter than normal. | On / Off | Off | 7-66 |
| Background exposure adjustment | Adjusts the ground color of the copied paper. | -2 – +2 | Standard setting (0) | 7-67 |
| Paper selection | Sets whether the copier will automatically select the same size of copy paper as the original once an original is set (APS: auto paper selection mode), or whether the drawer[cassette] selected “Default drawer” [“Default cassette”] setting will be automatically selected. | APS / Default drawer[cassette] | APS | 7-68 |
| Paper type (auto paper selection mode) | Sets which types of paper can be selected under the auto paper selection mode. * It is possible to select the type of paper that has been designated for the drawer[cassette] currently in use. | Off / On | On | 7-69 |
| | | Plain Preprinted Recycled Letterhead Color [Colour] Prepunched Rough Bond High quality Vellum Custom 1 – Custom 8 | Plain | |
| Default drawer[cassette] | Sets one drawer[cassette] that will be selected automatically regardless of the size of paper loaded in that drawer[cassette]. * It is NOT possible to select the multi-bypass tray as the default drawer[cassette]. * The setting for drawer[cassette] No.3 and No.4 will only be available when the optional Paper Feeder is installed on your copier. | 1st paper 2nd paper 3rd paper 4th paper | 1st paper | 7-70 |

Section 7 COPIER MANAGEMENT FUNCTIONS

| Default setting | Description | Available settings | Factory setting | Reference page |
|--|--|--|--|----------------|
| Cover drawer[cassette] | Sets which drawer[cassette] will be used to feed the cover sheets in the cover mode, the booklet/stitching mode and the book to booklet mode. * The setting for drawer[cassette] No.3 and No.4 will only be available when the optional Paper Feeder is installed on your copier. | 1st paper 2nd paper 3rd paper 4th paper Bypass | Bypass | 7-71 |
| Default magnification ratio | Sets whether or not the auto magnification selection mode will be used to automatically calculate the appropriate magnification ratio when you select the size of copy paper. | Manual / AMS | Manual | 7-72 |
| Auto exposure adjustment | Adjusts the overall exposure level for the auto exposure mode. | -3 – +3 | Standard setting (0) | 7-73 |
| Auto exposure adjustment (OCR) | Adjusts the overall exposure level for scanning with OCR (Optical Character Recognition) software when using the optional scanner functions of this copier. | -3 – +3 | Standard setting (0) | 7-74 |
| Manual exposure adjustment (text+photo mode) | Adjusts the median exposure value when the text+photo mode is selected for the image quality. | -3 – +3 | Standard setting (0) | 7-75 |
| Manual exposure adjustment (text mode) | Adjusts the median exposure value when the text mode is selected for the image quality. | -3 – +3 | Standard setting (0) | 7-76 |
| Manual exposure adjustment (photo mode) | Adjusts the median exposure value when the photo mode is selected for the image quality. | -3 – +3 | Standard setting (0) | 7-77 |
| Sort/Finished mode ON/OFF | Determines whether or not the Sort and/or the Finished modes will be the default setting in the initial mode. | Sort mode : On / Off Finished mode : Off / On [1 set (Output each page)] | Sort mode : On Finished mode : Off | 7-78 |
| Auto Rotation mode | Determines whether or not the Auto Rotation mode will be the default setting in the initial mode. If Auto Rotation is turned ON, the image will be automatically rotated even if the orientation of the original is different from that of the paper loaded in the drawers[cassettes]. | Rotate / No Rotate | Rotate | 7-79 |
| Margin width | Determines the default value of the location and width of the margins in the margin mode. | Inch specification 0 – 3/4 (inches) Metric specification 0 – 18 (mm) | Inch specification Left: 1/4 (inches) Top: 0 (inches) Metric specification Left: 6 (mm) Top: 0 (mm) | 7-80 |

Section 7 COPIER MANAGEMENT FUNCTIONS

| Default setting | Description | Available settings | Factory setting | Reference page |
|---|---|--|--|----------------|
| Erased border width | Determines the default value for the width of the border to be erased in the two border erase modes. | Inch specification Outside border: 0 – 3/4 (inches) Center area: 0 – 1 1/2 (inches) | Inch specification Outside border: 1/4 (inches) Center area: 1/2 (inches) | 7-81 |
| | | Metric specification Outside border: 0 – 18 (mm) Center area: 0 – 36 (mm) | Metric specification Outside border: 6 (mm) Center area: 12 (mm) | |
| Copy limit | Sets the limit for the number of copies (or copy sets) that can be made at a time. | 1 – 999 | 999 | 7-82 |
| Repeat copying ON/ OFF | Sets whether or not to prohibit repeat copying, as well as whether or not to make repeat copying the default setting in the initial mode. Sets whether to turn the repeat copy mode ON or OFF. | Off / On | On | 7-83 |
| | Sets whether or not to make repeat copying the default setting in the initial mode. * This setting is displayed when the optional Hard Disk is installed. | Off / On | Off | |
| Registration keys ON/ OFF | Sets whether or not to allow a “Register” key to be displayed in the screen for those function and modes which can be registered under the registration keys. Functions and/or modes can only be registered under registration keys through the “Register” key. | Off / On | On | 7-84 |
| Customize screen layout (Main functions) | Changes the order of the main functions and modes that are displayed in the “Basic” and the “User choice” tabs in order to make the display more appropriate to the way you use the copier. * Up to 6 functions and modes can be listed and displayed. | Exposure Mode / Reduce/Enlarge / Sort/Finished / 1/2 sided / Original size / Orig. quality [Quality orig.] | 1 Exposure Mode 2 Reduce/Enlarge 3 Sort/Finished 4 1/2 sided 5 Original size 6 Orig. quality [Quality orig.] | 7-85 |
| Customize screen layout (Add functions) | Adds often-used functions and/or modes, and changes the order of their layout, in order to make the display more appropriate to the way you use the copier. | All functions and modes other than those in the “Basic” tab and the “main functions” in the “User choice” tab. | 7 Margin 8 Border Erase [Erase Mode] 9 Combine [Merge] 10 (None) 11 (None) 12 (None) 13 (None) | 7-86 |

Section 7 COPIER MANAGEMENT FUNCTIONS

(5) Accessing the copy default settings

Perform the following procedure when you want to access the screens for each of the various copy default settings.

- 1 With the content of the “Basic” tab displayed, press the [Default Setting/Counter] key. The “Default setting” screen will be displayed.

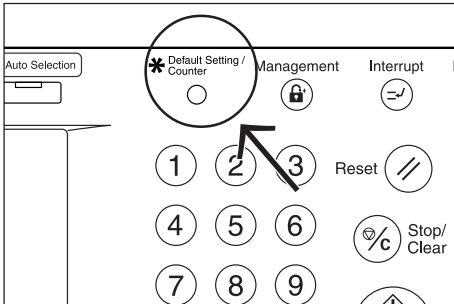

- 2 Touch the “Copy default” key on the left side of the touch panel.

Inch specifications

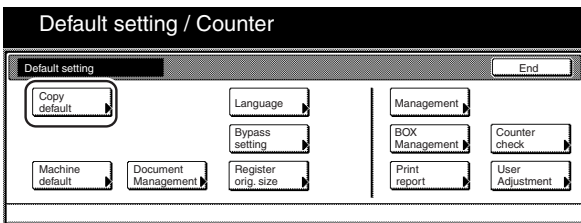

Metric specifications

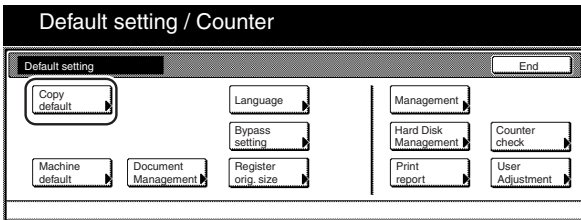

- 3 Use the keypad to enter the 4-digit management code. The factory default setting for 30 cpm copiers is “3000”, for 40 cpm copiers is “4000” and for 50 cpm copiers is “5000”.

Inch specifications

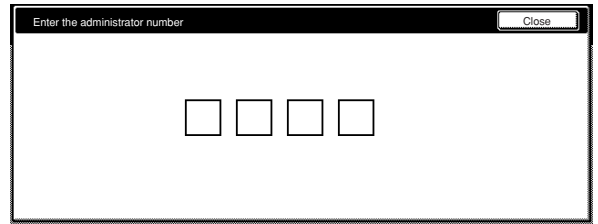

Metric specifications

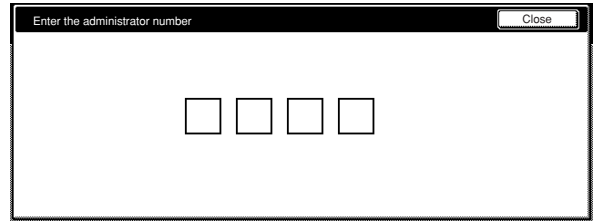

- 4 If the entered code matched the registered one, the “Copy default” screen will be displayed.

Inch specifications

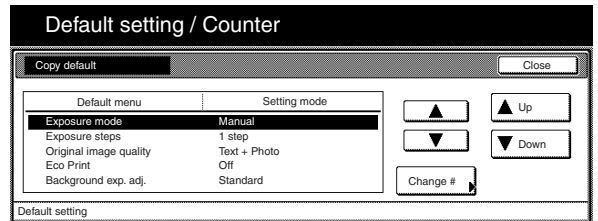

Metric specifications

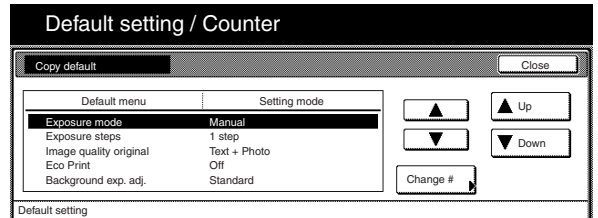

NOTES

- It is possible for you to change the 4-digit management code. (See “Changing the management code” on page 7-56.)
- Refer to the desired procedure(s) explained under “(6) Making copy default settings” and perform the corresponding setting(s).

(6) Making copy default settings

Perform the following procedure that corresponds to the desired setting.

● Exposure mode

Perform the following procedure to select between auto exposure and manual exposure as the default copy exposure mode in the initial mode.

- 1 Display the “Copy default” screen.
(See “(5) Accessing the copy default settings” on page 7-62.)

Inch specifications

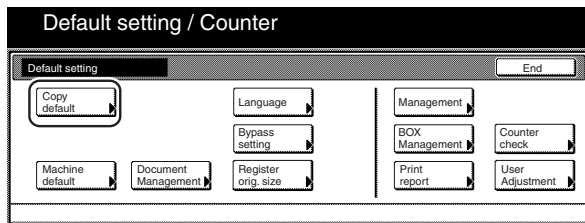

Metric specifications

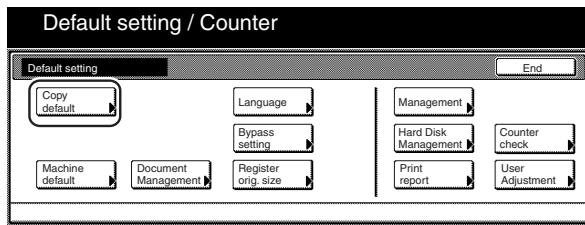

- 2 Select “Exposure mode” in the settings list on the left side of the touch panel and then touch the “Change #” key. The “Exposure mode” screen will be displayed.

Inch specifications

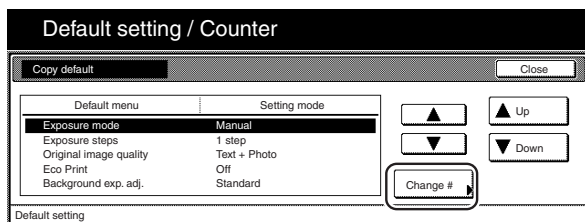

Metric specifications

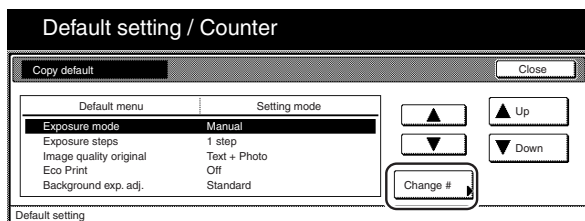

- 3 Touch the “Manual” key or the “Auto” key, as appropriate.

Inch specifications

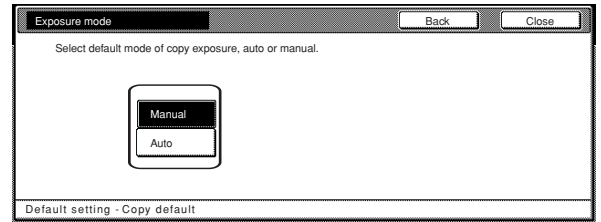

Metric specifications

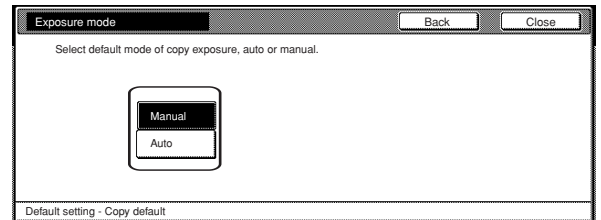

NOTE

If you want to quit the displayed setting without changing it, touch the “Back” key. The touch panel will return to the screen in step 2.

- 4 Touch the “Close” key. The touch panel will return to the screen in step 2.
- 5 Touch the “Close” key once again. The touch panel will return to the “Default setting” screen.
- 6 Touch the “End” key. The touch panel will return to the contents of the “Basic” tab.

Section 7 COPIER MANAGEMENT FUNCTIONS

● Exposure adjustment step

Perform the following procedure to change the incremental step to be used during adjustment of the copy exposure.

- 1 Display the "Copy default" screen.
(See "(5) Accessing the copy default settings" on page 7-62.)

Inch specifications

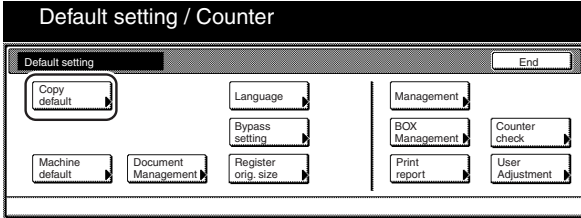

Metric specifications

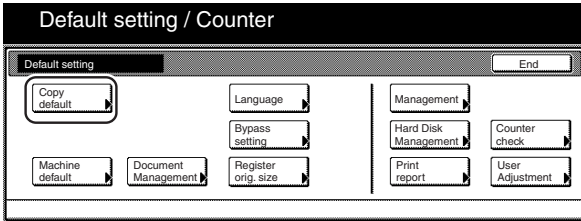

- 2 Select "Exposure steps" in the settings list on the left side of the touch panel and then touch the "Change #" key. The "Exposure steps" screen will be displayed.

Inch specifications

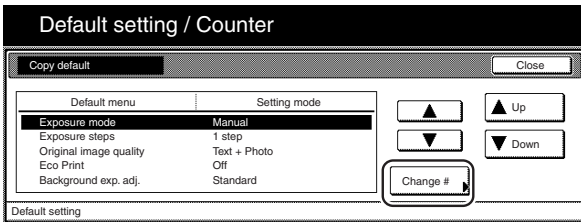

Metric specifications

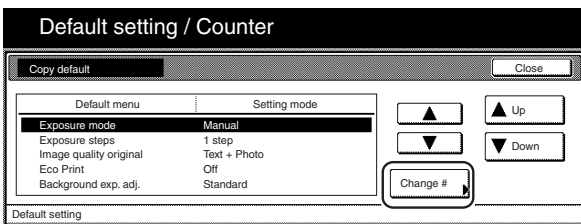

- 3 Touch the "1 step" key or the "0.5 step" key, as appropriate.
Inch specifications

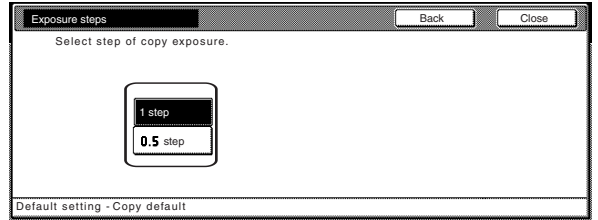

Metric specifications

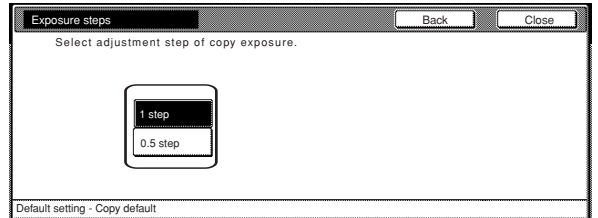

NOTE

If you want to quit the displayed setting without changing it, touch the "Back" key. The touch panel will return to the screen in step 2.

- 4 Touch the "Close" key. The touch panel will return to the screen in step 2.

- 5 Touch the "Close" key once again. The touch panel will return to the "Default setting" screen.

- 6 Touch the "End" key. The touch panel will return to the contents of the "Basic" tab.

● Original quality

Perform the following procedure to determine the default setting that will be used for the image quality in the initial mode.

- 1 Display the “Copy default” screen.
(See “(5) Accessing the copy default settings” on page 7-62.)

Inch specifications

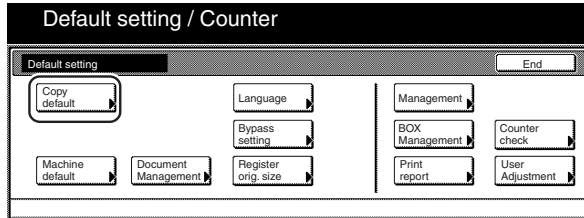

Metric specifications

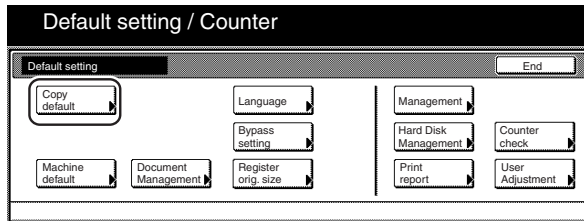

- 2 Select “Original image quality” [“Image quality Original”] in the settings list on the left side of the touch panel and then touch the “Change #” key.
The “Original image quality” [“Image quality Original”] screen will be displayed.

Inch specifications

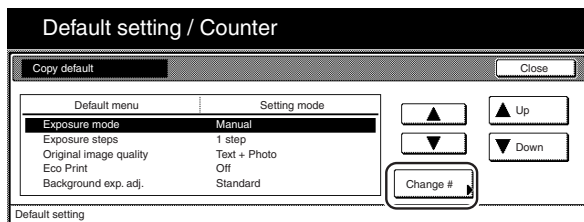

Metric specifications

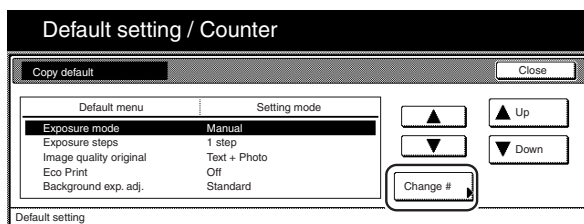

- 3 Touch the “Text+Photo” key, the “Photo” key or the “Text” key, as appropriate.

Inch specifications

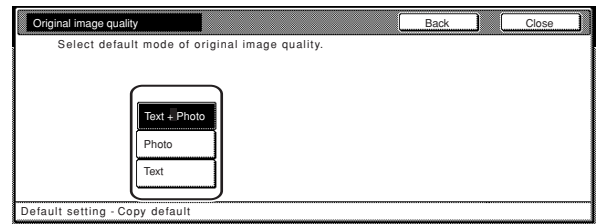

Metric specifications

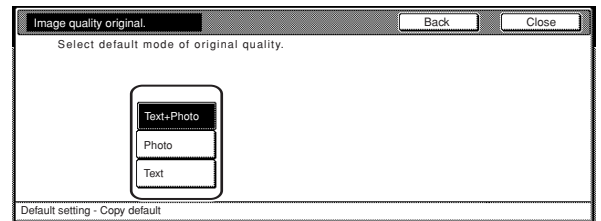

NOTE

If you want to quit the displayed setting without changing it, touch the “Back” key. The touch panel will return to the screen in step 2.

- 4 Touch the “Close” key. The touch panel will return to the screen in step 2.
- 5 Touch the “Close” key once again. The touch panel will return to the “Default setting” screen.
- 6 Touch the “End” key. The touch panel will return to the contents of the “Basic” tab.

Section 7 COPIER MANAGEMENT FUNCTIONS

● Eco print mode ON/OFF

Perform the following procedure to determine whether or not the eco print mode will be the default setting in the initial mode.

- 1 Display the "Copy default" screen.
(See "(5) Accessing the copy default settings" on page 7-62.)

Inch specifications

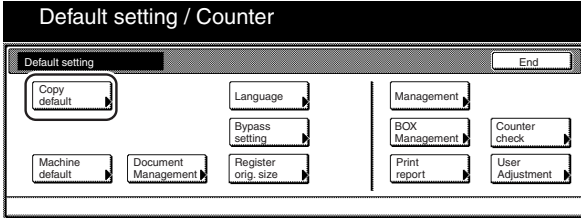

Metric specifications

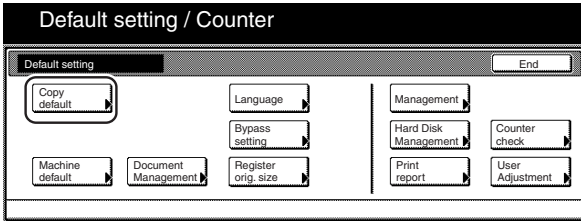

- 2 Select "Eco Print" in the settings list on the left side of the touch panel and then touch the "Change #" key. The "Eco Print" screen will be displayed.

Inch specifications

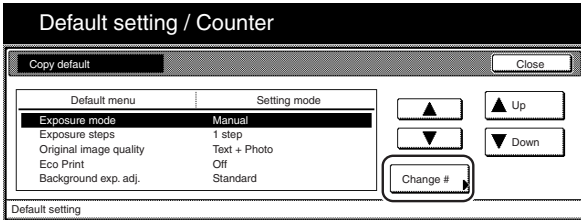

Metric specifications

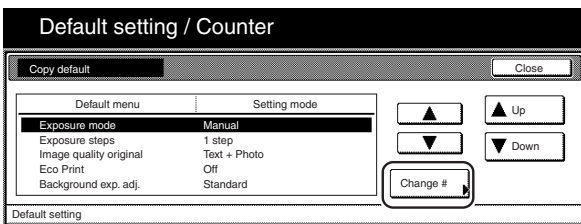

- 3 Touch the "On" key if you want to make the eco print mode the default setting in the initial mode.

Inch specifications

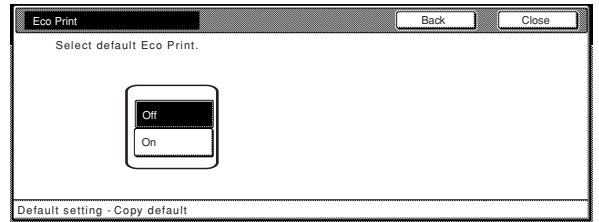

Metric specifications

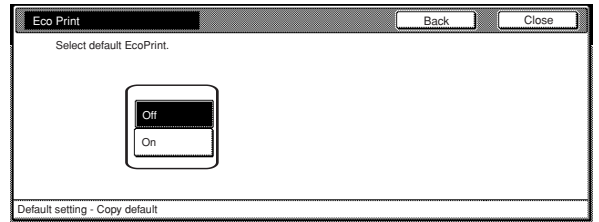

NOTE

If you want to quit the displayed setting without changing it, touch the "Back" key. The touch panel will return to the screen in step 2.

- 4 Touch the "Close" key. The touch panel will return to the screen in step 2.

- 5 Touch the "Close" key once again. The touch panel will return to the "Default setting" screen.

- 6 Touch the "End" key. The touch panel will return to the contents of the "Basic" tab.

● Background exposure adjustment

Perform the following procedure to adjust the ground color of the copied paper.

- 1 Display the "Copy default" screen.
(See "(5) Accessing the copy default settings" on page 7-62.)

Inch specifications

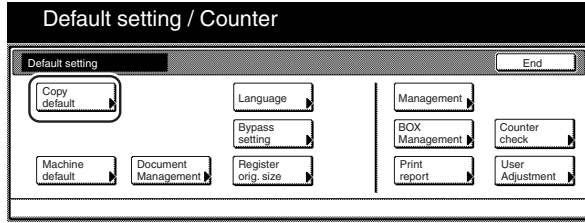

Metric specifications

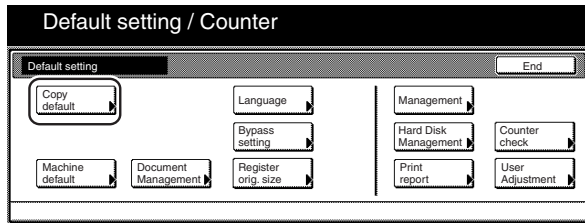

- 2 Select "Background exp. adj." in the settings list on the left side of the touch panel and then touch the "Change #" key. The "Background exp. adj." screen will be displayed.

Inch specifications

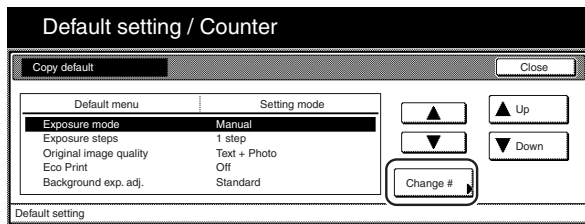

Metric specifications

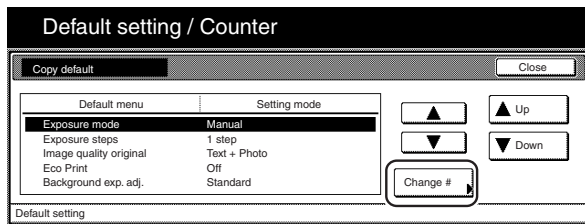

- 3 Touch the "Lighter" key or "Darker" key to adjust density.

Inch specifications

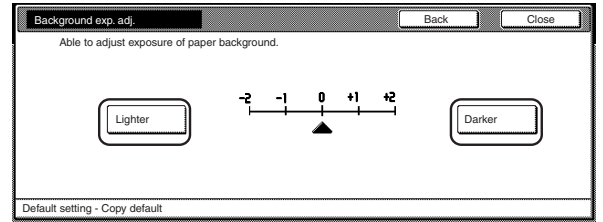

Metric specifications

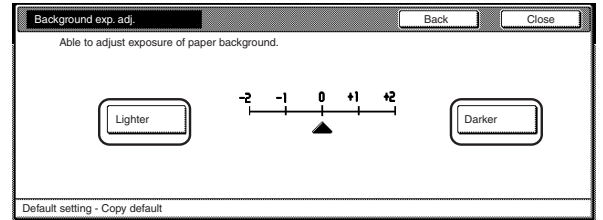

NOTE

If you want to quit the displayed setting without changing it, touch the "Back" key. The touch panel will return to the screen in step 2.

- 4 Touch the "Close" key. The touch panel will return to the screen in step 2.

- 5 Touch the "Close" key once again. The touch panel will return to the "Default setting" screen.

- 6 Touch the "End" key. The touch panel will return to the contents of the "Basic" tab.

Section 7 COPIER MANAGEMENT FUNCTIONS

● Paper selection

Perform the following procedure to set whether the copier will automatically select the same size of copy paper as the original once an original is set, or whether the designated default drawer[cassette] will be automatically selected.

- 1 Display the "Copy default" screen.
(See "(5) Accessing the copy default settings" on page 7-62.)

Inch specifications

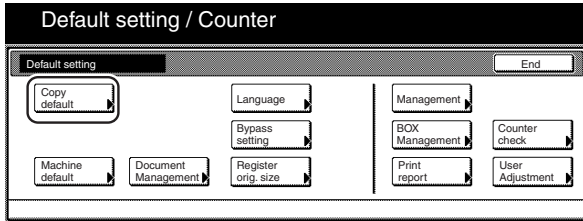

Metric specifications

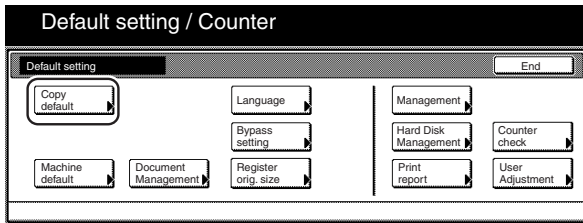

- 2 Select "Select paper" in the settings list on the left side of the touch panel and then touch the "Change #" key. The "Select paper" screen will be displayed.

Inch specifications

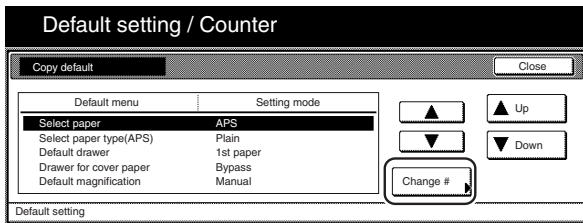

Metric specifications

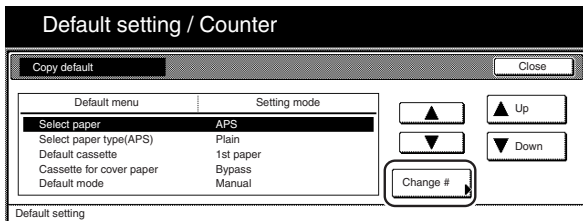

- 3 Touch the "APS" key to have the same size of copy paper as the original selected automatically, and the "Default drawer[cassette]" key to have paper fed from the designated default drawer[cassette].

Inch specifications

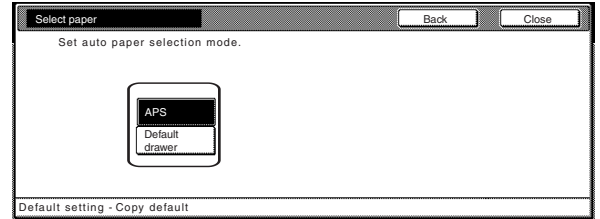

Metric specifications

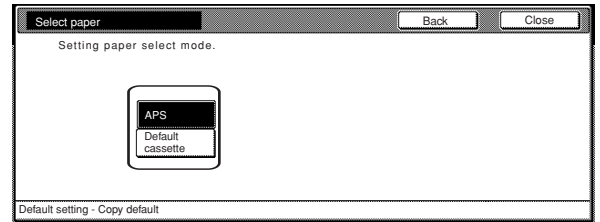

NOTE

If you want to quit the displayed setting without changing it, touch the "Back" key. The touch panel will return to the screen in step 2.

- 4 Touch the "Close" key. The touch panel will return to the screen in step 2.
- 5 Touch the "Close" key once again. The touch panel will return to the "Default setting" screen.
- 6 Touch the "End" key. The touch panel will return to the contents of the "Basic" tab.

● Paper type (auto paper selection mode)

Perform the following procedure to set which types of paper can be selected under the auto paper selection mode.

- 1 Display the "Copy default" screen. (See "(5) Accessing the copy default settings" on page 7-62.)

Inch specifications

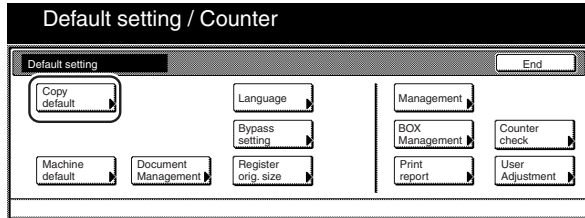

Metric specifications

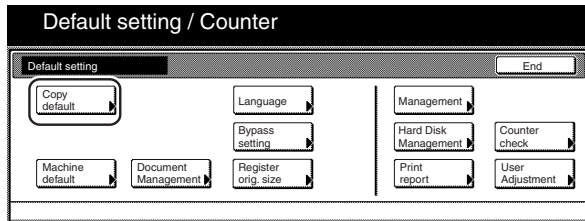

- 2 Select "Select paper type(APS)" in the settings list on the left side of the touch panel and then touch the "Change #" key. The "Select paper type(APS)" screen will be displayed.

Inch specifications

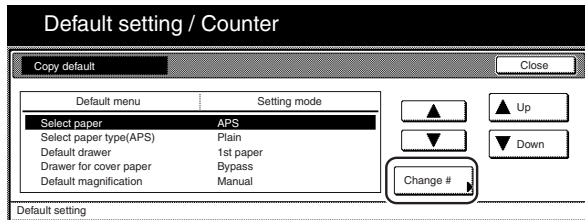

Metric specifications

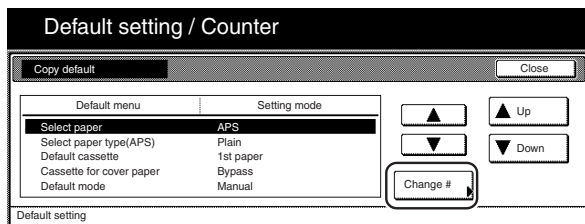

- 3 Touch the "On" key and then touch the key that corresponds to the types of paper you want to allow to be used under the auto paper selection mode. If you do NOT want to limit the types of paper that will be available for use in that mode, touch the "Off" key.

Inch specifications

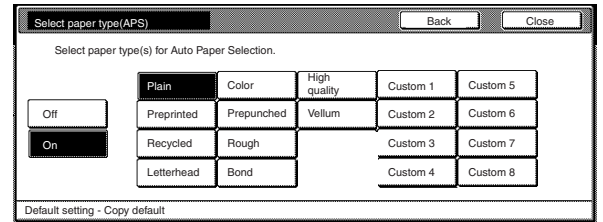

Metric specifications

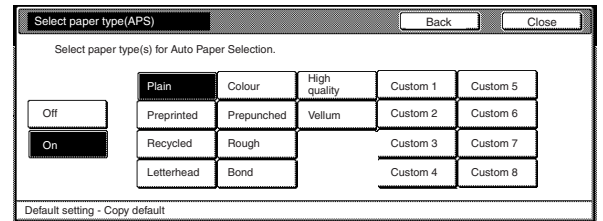

NOTES

- It is possible to select the type of paper that has been designated for the drawer[cassette] currently in use.
- If you want to quit the displayed setting without changing it, touch the "Back" key. The touch panel will return to the screen in step 2.

- 4 Touch the "Close" key. The touch panel will return to the screen in step 2.

- 5 Touch the "Close" key once again. The touch panel will return to the "Default setting" screen.

- 6 Touch the "End" key. The touch panel will return to the contents of the "Basic" tab.

Section 7 COPIER MANAGEMENT FUNCTIONS

● Default drawer[cassette]

Perform the following procedure to set one drawer[cassette] that will be selected automatically regardless of the size of paper loaded in that drawer[cassette].

* It is NOT possible to select the multi-bypass tray as the default drawer[cassette].

- 1 Display the "Copy default" screen.
(See "(5) Accessing the copy default settings" on page 7-62.)

Inch specifications

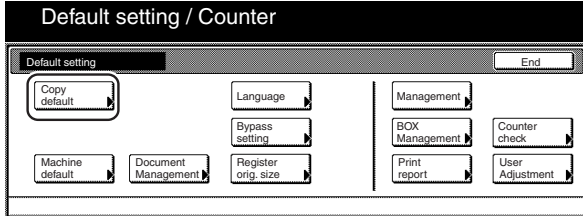

Metric specifications

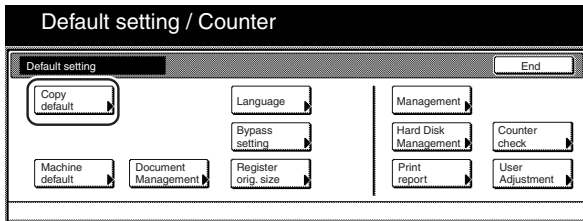

- 2 Select "Default drawer[cassette]" in the settings list on the left side of the touch panel and then touch the "Change #" key. The "Default drawer[cassette]" screen will be displayed.

Inch specifications

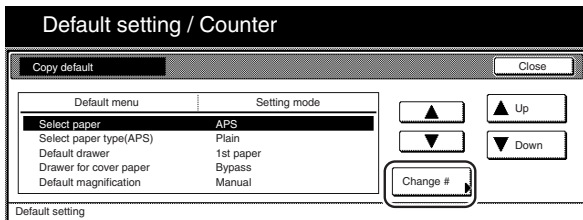

Metric specifications

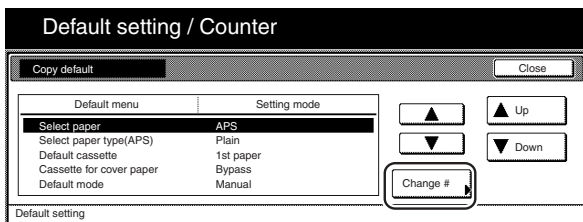

- 3 Touch the key that corresponds to the desired drawer[cassette].

Inch specifications

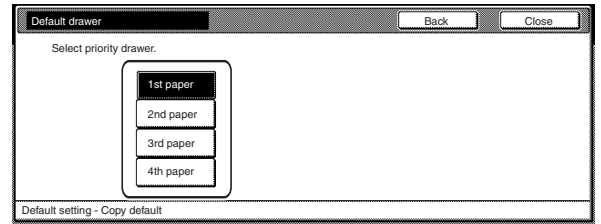

Metric specifications

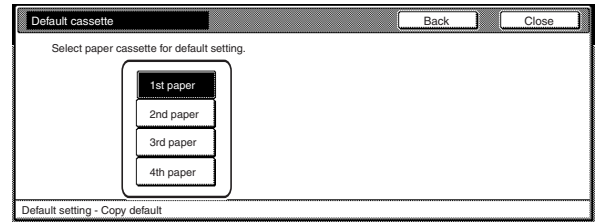

NOTES

- If you want to quit the displayed setting without changing it, touch the "Back" key. The touch panel will return to the screen in step 2.
- The setting for drawer[cassette] No.3 and No.4 will only be available when the optional Paper Feeder is installed on your copier.

- 4 Touch the "Close" key. The touch panel will return to the screen in step 2.

- 5 Touch the "Close" key once again. The touch panel will return to the "Default setting" screen.

- 6 Touch the "End" key. The touch panel will return to the contents of the "Basic" tab.

● Cover drawer[cassette]

Perform the following procedure to set which drawer[cassette] will be used to feed the cover sheets in the cover mode, the booklet/stitching mode and the book to booklet mode.

- 1 Display the “Copy default” screen.
(See “(5) Accessing the copy default settings” on page 7-62.)

Inch specifications

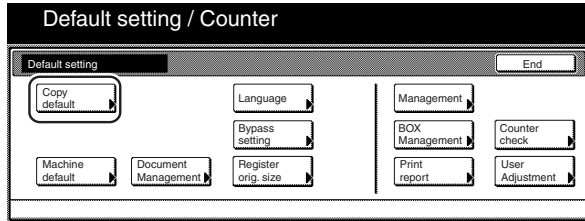

Metric specifications

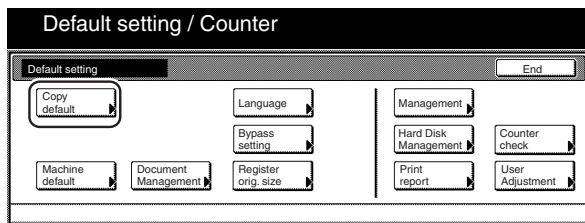

- 2 Select “Drawer for cover paper” [“Cassette for cover paper”] in the settings list on the left side of the touch panel and then touch the “Change #” key.
The “Drawer for cover paper” [“Cassette for cover paper”] screen will be displayed.

Inch specifications

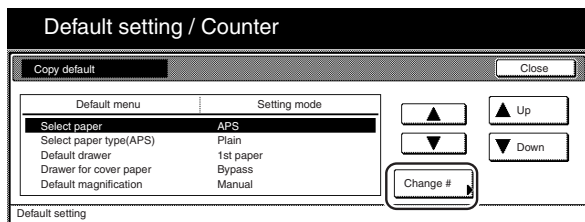

Metric specifications

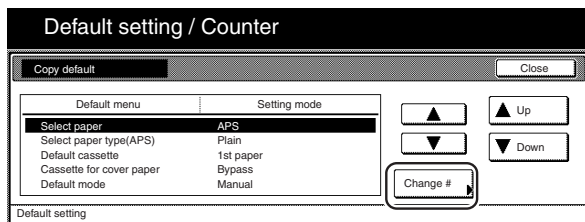

- 3 Touch the key that corresponds to the desired drawer[cassette].

Inch specifications

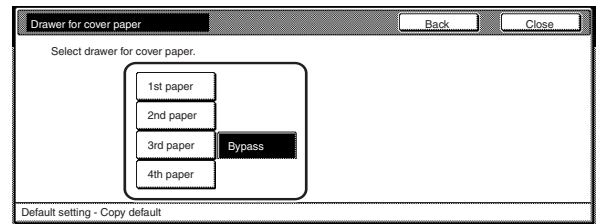

Metric specifications

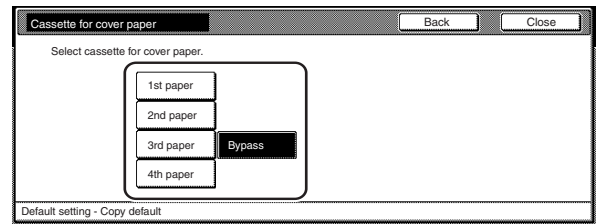

NOTES

- If you want to quit the displayed setting without changing it, touch the “Back” key. The touch panel will return to the screen in step 2.
- The setting for drawer[cassette] No.3 and No.4 will only be available when the optional Paper Feeder is installed on your copier.

- 4 Touch the “Close” key. The touch panel will return to the screen in step 2.

- 5 Touch the “Close” key once again. The touch panel will return to the “Default setting” screen.

- 6 Touch the “End” key. The touch panel will return to the contents of the “Basic” tab.

Section 7 COPIER MANAGEMENT FUNCTIONS

● Default magnification ratio

Perform the following procedure to set whether or not the appropriate magnification ratio to be calculated automatically when you select the size of copy paper.

- 1 Display the "Copy default" screen.
(See "(5) Accessing the copy default settings" on page 7-62.)

Inch specifications

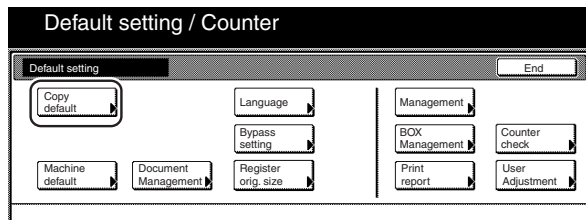

Metric specifications

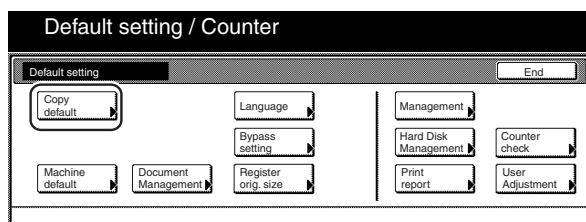

- 2 Select "Default magnification" ["Default mode"] in the settings list on the left side of the touch panel and then touch the "Change #" key.
The "Default magnification" ["Default mode"] screen will be displayed.

Inch specifications

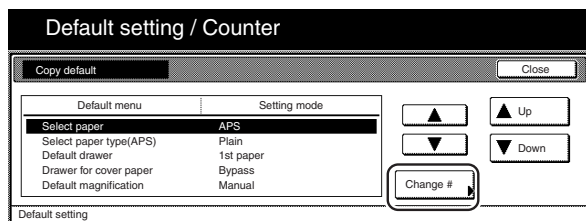

Metric specifications

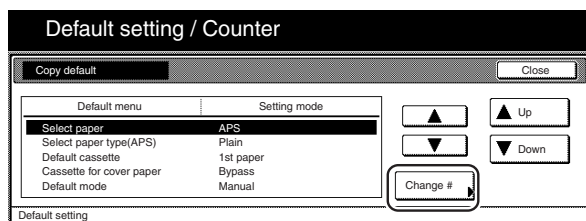

- 3 Touch the "Manual" key or the "AMS" key, as appropriate.

Inch specifications

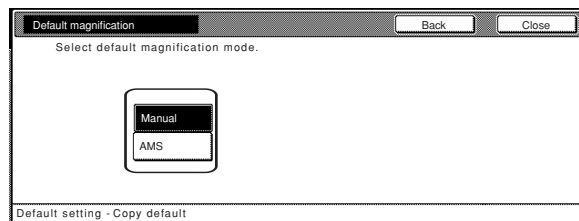

Metric specifications

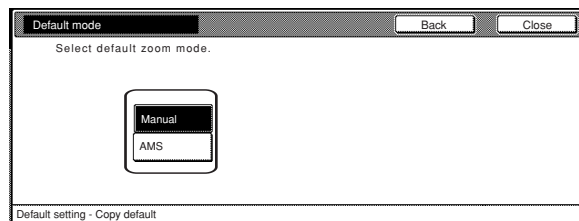

NOTE

If you want to quit the displayed setting without changing it, touch the "Back" key. The touch panel will return to the screen in step 2.

- 4 Touch the "Close" key. The touch panel will return to the screen in step 2.
- 5 Touch the "Close" key once again. The touch panel will return to the "Default setting" screen.
- 6 Touch the "End" key. The touch panel will return to the contents of the "Basic" tab.

● Auto exposure adjustment

Perform the following procedure to adjust the overall exposure level for the auto exposure mode.

- 1 Display the "Copy default" screen. (See "(5) Accessing the copy default settings" on page 7-62.)

Inch specifications

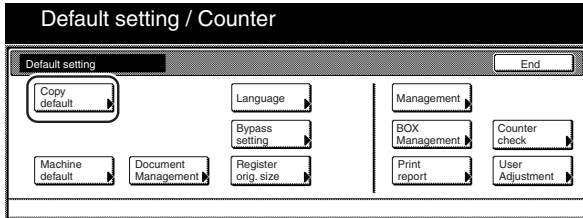

Metric specifications

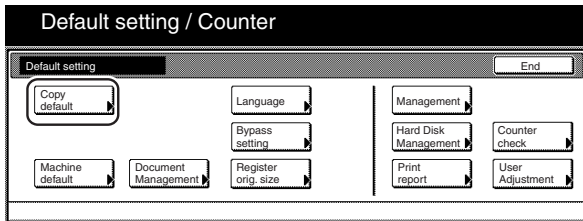

- 2 Select "Adjust auto exposure." in the settings list on the left side of the touch panel and then touch the "Change #" key. The "Adjust auto exposure." screen will be displayed.

Inch specifications

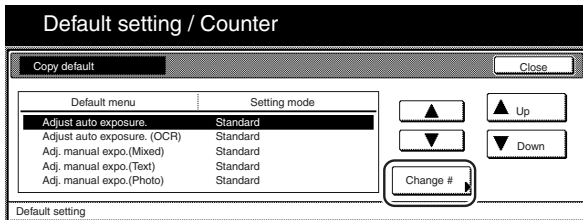

Metric specifications

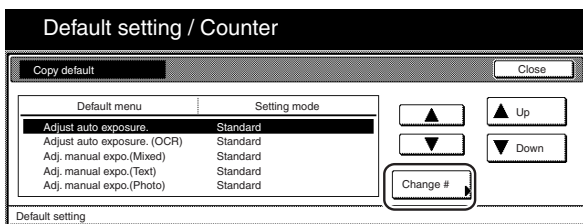

- 3 Touch the "Lighter" key or the "Darker" key, as appropriate, to move the cursor on the exposure scale and adjust the exposure as desired.

Inch specifications

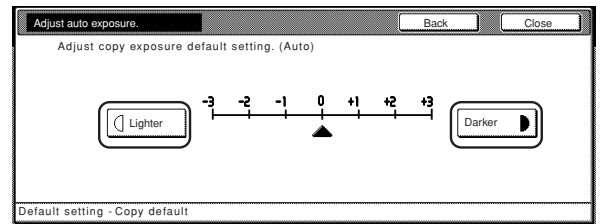

Metric specifications

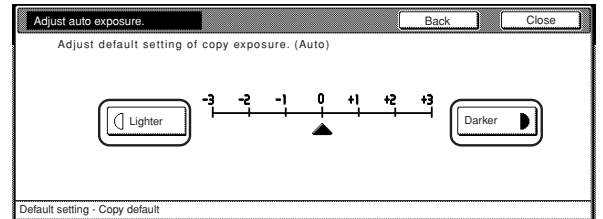

NOTE

If you want to quit the displayed setting without changing it, touch the "Back" key. The touch panel will return to the screen in step 2.

- 4 Touch the "Close" key. The touch panel will return to the screen in step 2.
- 5 Touch the "Close" key once again. The touch panel will return to the "Default setting" screen.
- 6 Touch the "End" key. The touch panel will return to the contents of the "Basic" tab.

Section 7 COPIER MANAGEMENT FUNCTIONS

● Auto exposure adjustment (OCR)

Perform the following procedure to adjust the overall exposure level for scanning with OCR (Optical Character Recognition) software when using the optional scanner functions of this copier.

- 1 Display the "Copy default" screen.
(See "(5) Accessing the copy default settings" on page 7-62.)

Inch specifications

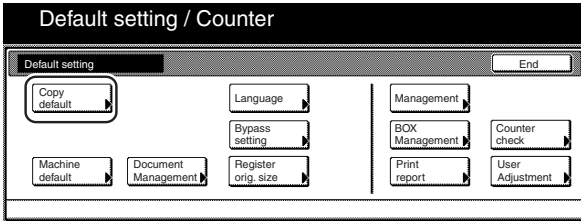

Metric specifications

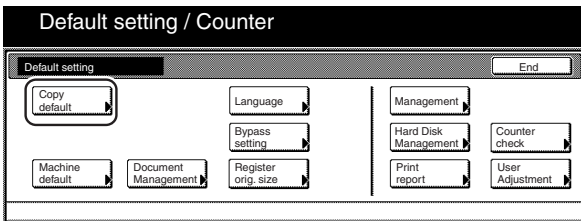

- 2 Select "Adjust auto exposure (OCR)" in the settings list on the left side of the touch panel and then touch the "Change #" key.
The "Adjust auto exposure (OCR)" screen will be displayed.

Inch specifications

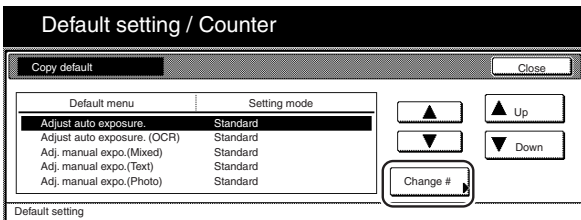

Metric specifications

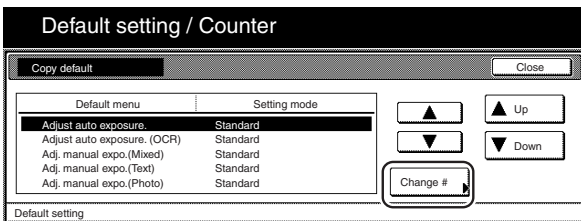

- 3 Touch the "Lighter" key or the "Darker" key, as appropriate, to move the cursor on the exposure scale and adjust the exposure as desired.

Inch specifications

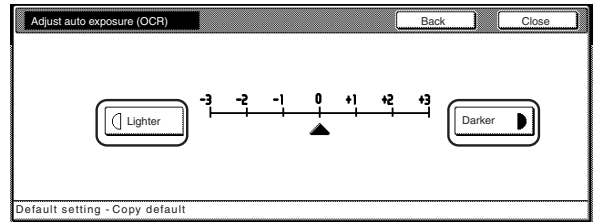

Metric specifications

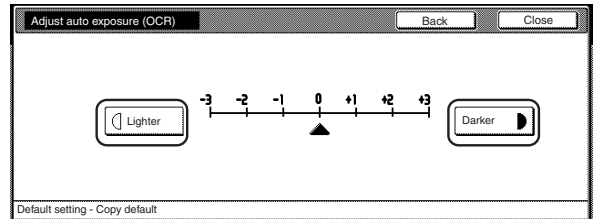

NOTE

If you want to quit the displayed setting without changing it, touch the "Back" key. The touch panel will return to the screen in step 2.

- 4 Touch the "Close" key. The touch panel will return to the screen in step 2.
- 5 Touch the "Close" key once again. The touch panel will return to the "Default setting" screen.
- 6 Touch the "End" key. The touch panel will return to the contents of the "Basic" tab.

● **Manual exposure adjustment (text+photo mode)**

Perform the following procedure to adjust the median exposure value when the text+photo mode is selected for the image quality.

- 1 Display the "Copy default" screen.
(See "(5) Accessing the copy default settings" on page 7-62.)

Inch specifications

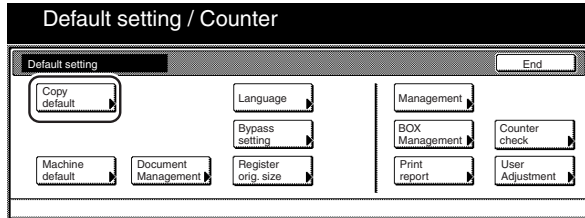

Metric specifications

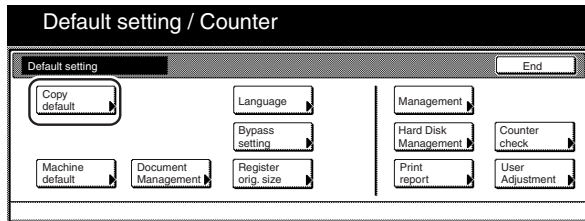

- 2 Select "Adj. Manual expo. (Mixed)" in the settings list on the left side of the touch panel and then touch the "Change #" key.

The "Adj. Manual expo. (Mixed)" screen will be displayed.

Inch specifications

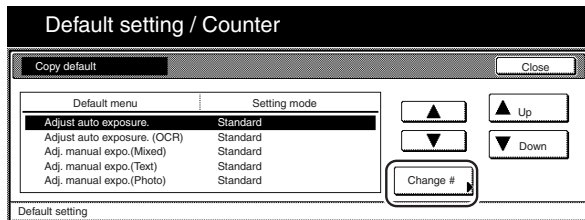

Metric specifications

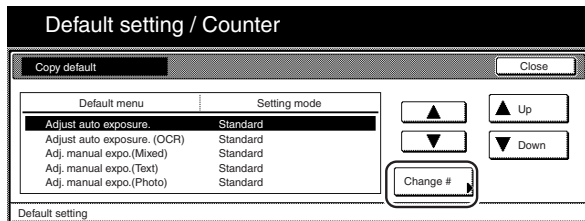

- 3 Touch the "Lighter" key or the "Darker" key, as appropriate, to move the cursor on the exposure scale and adjust the exposure as desired.

Inch specifications

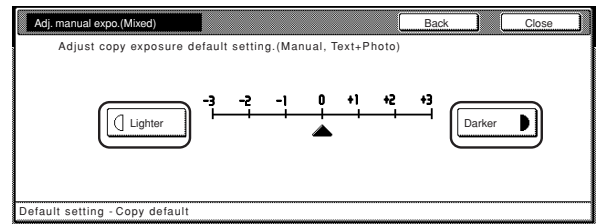

Metric specifications

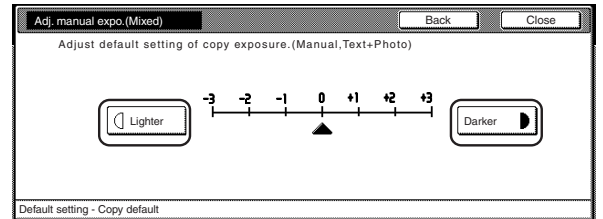

NOTE

If you want to quit the displayed setting without changing it, touch the "Back" key. The touch panel will return to the screen in step 2.

- 4 Touch the "Close" key. The touch panel will return to the screen in step 2.
- 5 Touch the "Close" key once again. The touch panel will return to the "Default setting" screen.
- 6 Touch the "End" key. The touch panel will return to the contents of the "Basic" tab.

Section 7 COPIER MANAGEMENT FUNCTIONS

● Manual exposure adjustment (text mode)

Perform the following procedure to adjust the median exposure value when the text mode is selected for the image quality.

- 1 Display the “Copy default” screen.
(See “(5) Accessing the copy default settings” on page 7-62.)

Inch specifications

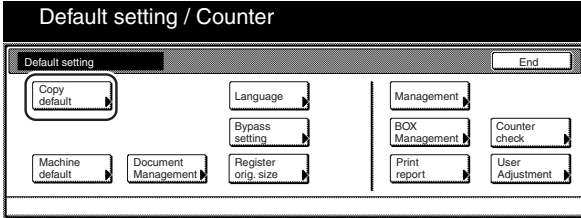

Metric specifications

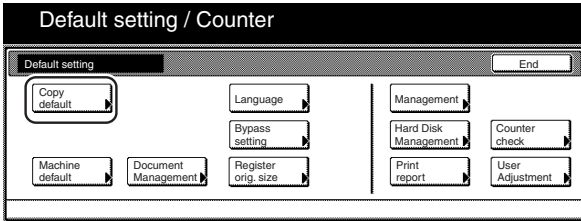

- 2 Select “Adj. manual expo. (Text)” in the settings list on the left side of the touch panel and then touch the “Change #” key.

The “Adj. manual expo. (Text)” screen will be displayed.

Inch specifications

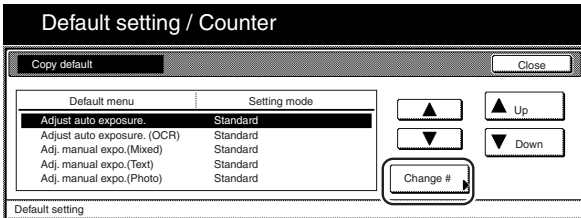

Metric specifications

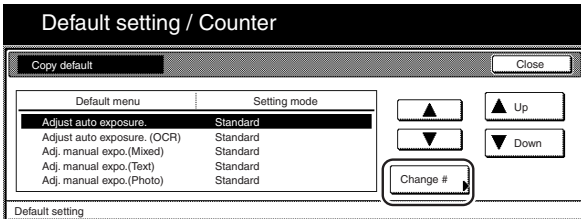

- 3 Touch the “Lighter” key or the “Darker” key, as appropriate, to move the cursor on the exposure scale and adjust the exposure as desired.

Inch specifications

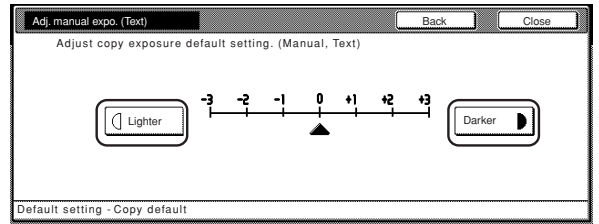

Metric specifications

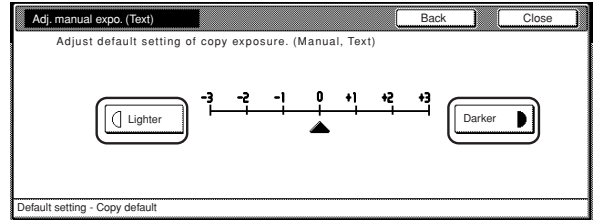

NOTE

If you want to quit the displayed setting without changing it, touch the “Back” key. The touch panel will return to the screen in step 2.

- 4 Touch the “Close” key. The touch panel will return to the screen in step 2.
- 5 Touch the “Close” key once again. The touch panel will return to the “Default setting” screen.
- 6 Touch the “End” key. The touch panel will return to the contents of the “Basic” tab.

● Manual exposure adjustment (photo mode)

Perform the following procedure to adjust the median exposure value when the photo mode is selected for the image quality.

- 1 Display the "Copy default" screen.
(See "(5) Accessing the copy default settings" on page 7-62.)

Inch specifications

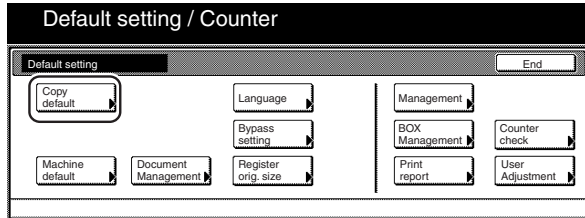

Metric specifications

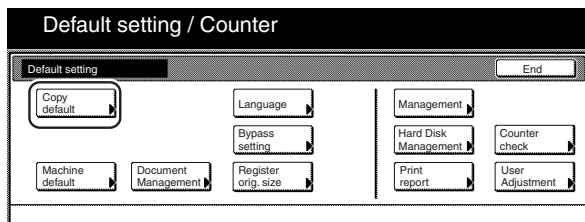

- 2 Select "Adj. manual expo. (Photo)" in the settings list on the left side of the touch panel and then touch the "Change #" key.

The "Adj. manual expo. (Photo)" screen will be displayed.

Inch specifications

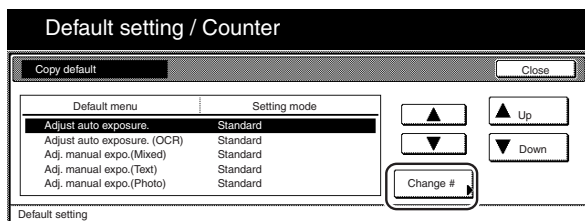

Metric specifications

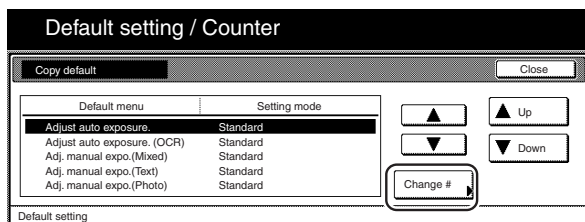

- 3 Touch the "Lighter" key or the "Darker" key, as appropriate, to move the cursor on the exposure scale and adjust the exposure as desired.

Inch specifications

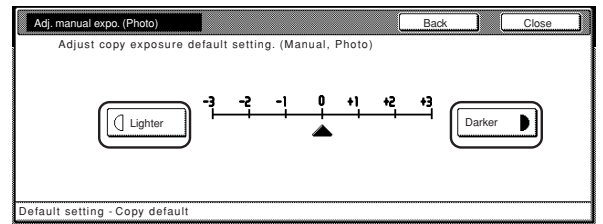

Metric specifications

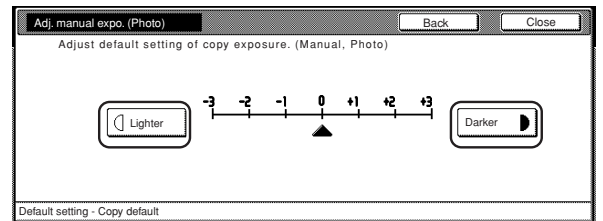

NOTE

If you want to quit the displayed setting without changing it, touch the "Back" key. The touch panel will return to the screen in step 2.

- 4 Touch the "Close" key. The touch panel will return to the screen in step 2.
- 5 Touch the "Close" key once again. The touch panel will return to the "Default setting" screen.
- 6 Touch the "End" key. The touch panel will return to the contents of the "Basic" tab.

Section 7 COPIER MANAGEMENT FUNCTIONS

● Sort/Finished mode ON/OFF

Perform the following procedure to determine whether or not the Sort and/or the Finished modes will be the default setting in the initial mode.

- 1 Display the "Copy default" screen.
(See "(5) Accessing the copy default settings" on page 7-62.)

Inch specifications

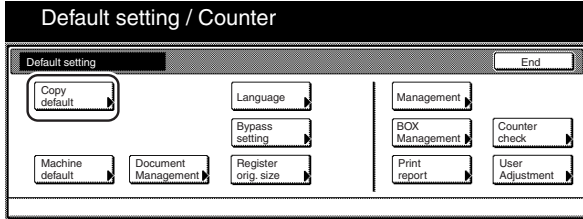

Metric specifications

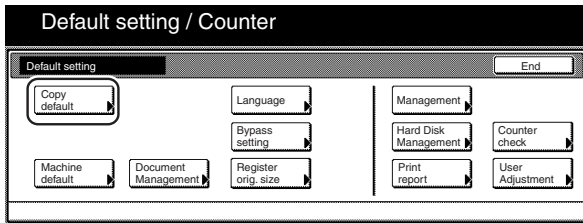

- 2 Select "Sort" in the settings list on the left side of the touch panel and then touch the "Change #" key. The "Sort" screen will be displayed.

Inch specifications

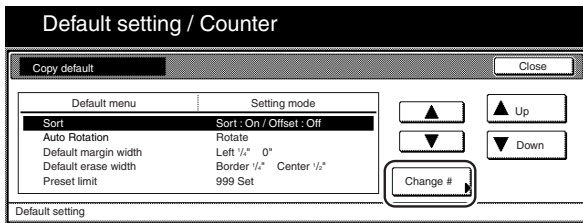

Metric specifications

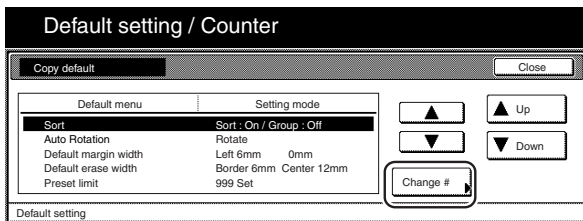

- 3 Touch the "Sort:On" key under "Sort" if you want to make the Sort mode the default setting in the initial mode.

Inch specifications

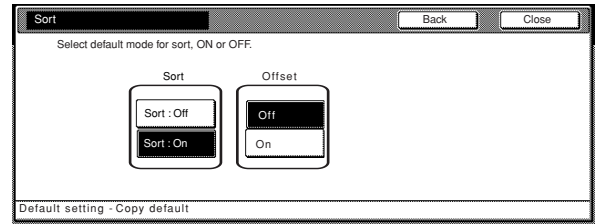

Metric specifications

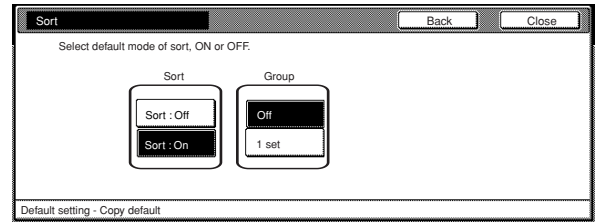

- 4 Touch the "On" ["1 set"] key under "Offset" ["Group"] if you want to make the Finished mode the default setting in the initial mode.
 - In metric specification copiers, if you select "Sort:Off" under "Sort", the "1 set" key that appears under "Group" will change to the "Output each page" key.

NOTE

If you want to quit the displayed setting without changing it, touch the "Back" key. The touch panel will return to the screen in step 2.

- 5 Touch the "Close" key. The touch panel will return to the screen in step 2.

- 6 Touch the "Close" key once again. The touch panel will return to the "Default setting" screen.

- 7 Touch the "End" key. The touch panel will return to the contents of the "Basic" tab.

● Auto Rotation mode ON/OFF

Perform the following procedure to determine whether or not the Auto Rotation mode will be the default setting in the initial mode.

- 1 Display the "Copy default" screen.
(See "(5) Accessing the copy default settings" on page 7-62.)

Inch specifications

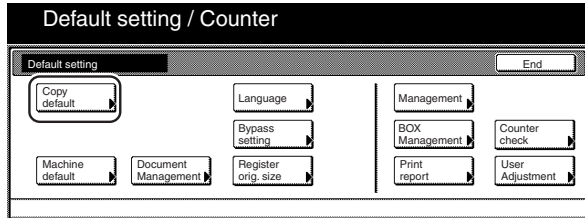

Metric specifications

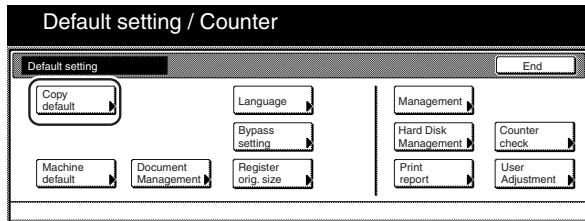

- 2 Select "Auto Rotation" in the settings list on the left side of the touch panel and then touch the "Change #" key. The "Auto Rotation" screen will be displayed.

Inch specifications

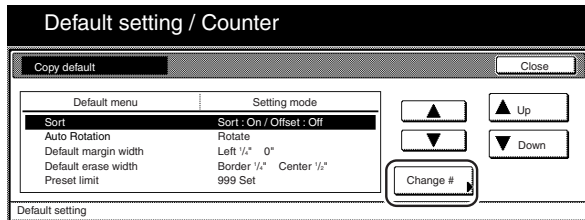

Metric specifications

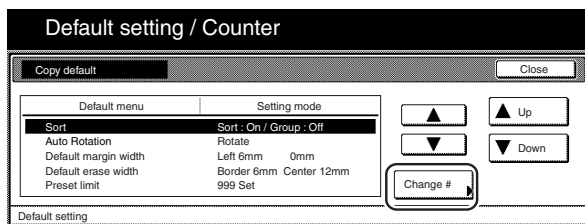

- 3 Touch the "Rotate" key if you want to make the Auto Rotation mode the default setting in the initial mode.

Inch specifications

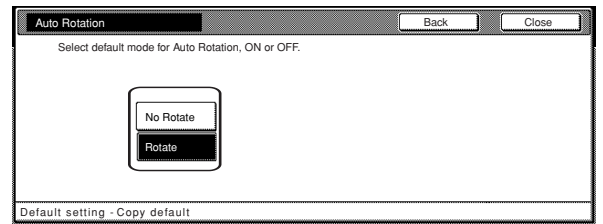

Metric specifications

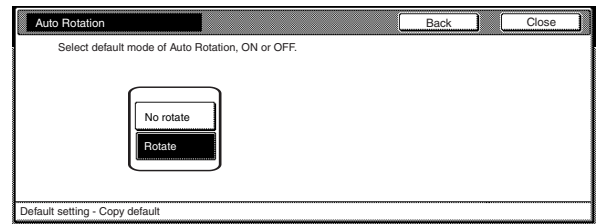

NOTE

If you want to quit the displayed setting without changing it, touch the "Back" key. The touch panel will return to the screen in step 2.

- 4 Touch the "Close" key. The touch panel will return to the screen in step 2.
- 5 Touch the "Close" key once again. The touch panel will return to the "Default setting" screen.
- 6 Touch the "End" key. The touch panel will return to the contents of the "Basic" tab.

Section 7 COPIER MANAGEMENT FUNCTIONS

● Margin width

Perform the following procedure to determine the default value of the location and width of the margins in the margin mode.

- 1 Display the "Copy default" screen.
(See "(5) Accessing the copy default settings" on page 7-62.)

Inch specifications

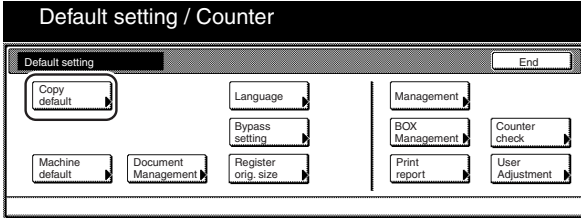

Metric specifications

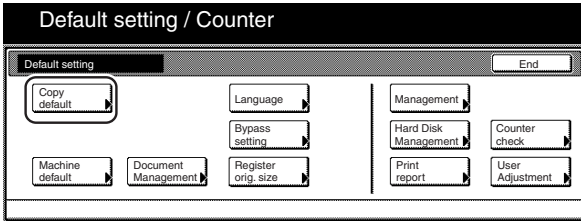

- 2 Select "Default margin width" in the settings list on the left side of the touch panel and then touch the "Change #" key. The "Default margin width" screen will be displayed.

Inch specifications

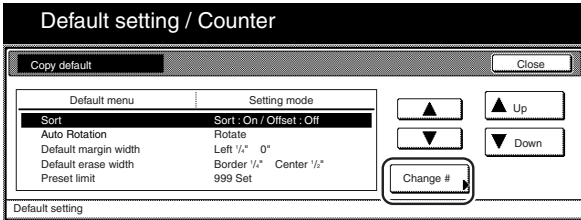

Metric specifications

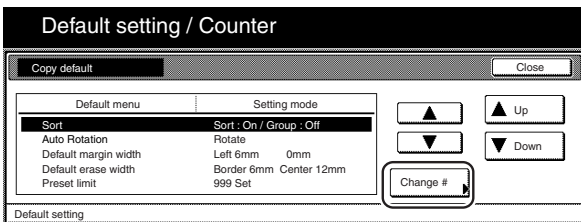

- 3 Touch the "◀" key or the "▶" key, and the "▲" key or the "▼" key, as desired, to change the default margins and margin widths to the desired setting.

Inch specifications

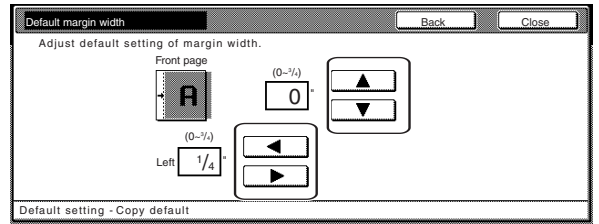

Metric specifications

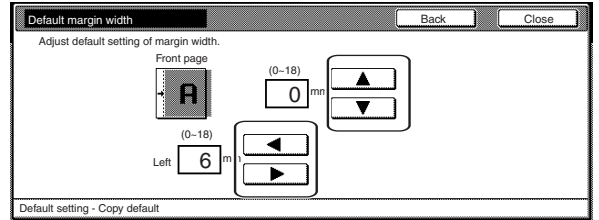

NOTE

If you want to quit the displayed setting without changing it, touch the "Back" key. The touch panel will return to the screen in step 2.

- 4 Touch the "Close" key. The touch panel will return to the screen in step 2.
- 5 Touch the "Close" key once again. The touch panel will return to the "Default setting" screen.
- 6 Touch the "End" key. The touch panel will return to the contents of the "Basic" tab.

● Erased border width

Perform the following procedure to determine the default value for the width of the border to be erased in the two border erase modes.

- 1 Display the "Copy default" screen. (See "(5) Accessing the copy default settings" on page 7-62.)

Inch specifications

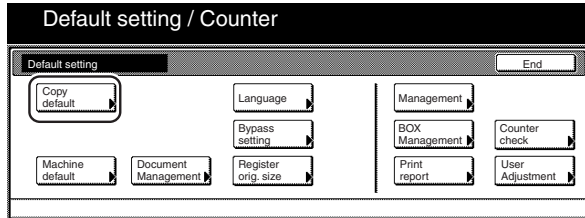

Metric specifications

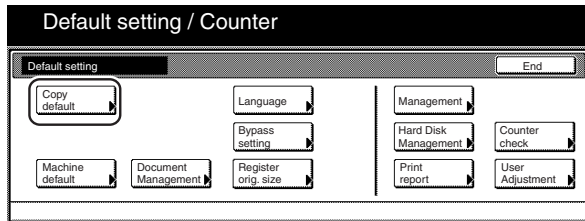

- 2 Select "Default erase width" in the settings list on the left side of the touch panel and then touch the "Change #" key. The "Default erase width" screen will be displayed.

Inch specifications

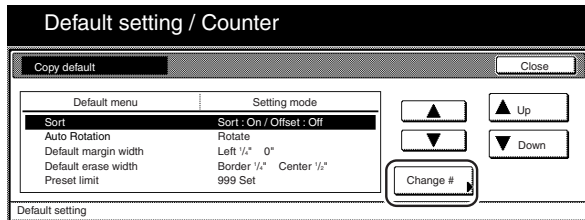

Metric specifications

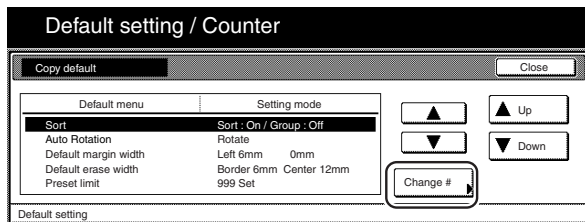

- 3 Touch the "+" key or the "-" key under the "Border" and "Center" fields to change the displayed widths to those desired.

Inch specifications

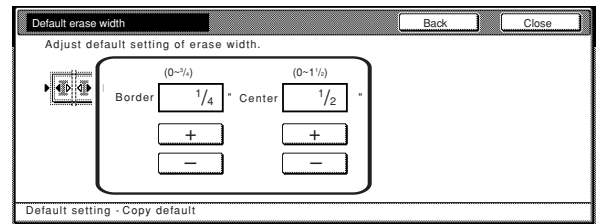

Metric specifications

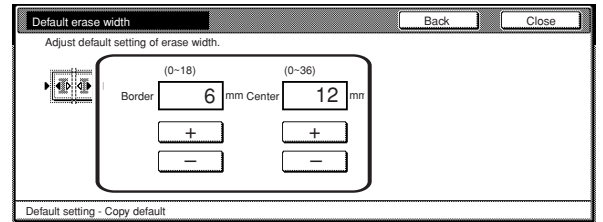

NOTE

If you want to quit the displayed setting without changing it, touch the "Back" key. The touch panel will return to the screen in step 2.

- 4 Touch the "Close" key. The touch panel will return to the screen in step 2.
- 5 Touch the "Close" key once again. The touch panel will return to the "Default setting" screen.
- 6 Touch the "End" key. The touch panel will return to the contents of the "Basic" tab.

Section 7 COPIER MANAGEMENT FUNCTIONS

● Copy limit

Perform the following procedure to set the limit for the number of copies (or copy sets) that can be made at a time.

- 1 Display the "Copy default" screen.
(See "(5) Accessing the copy default settings" on page 7-62.)

Inch specifications

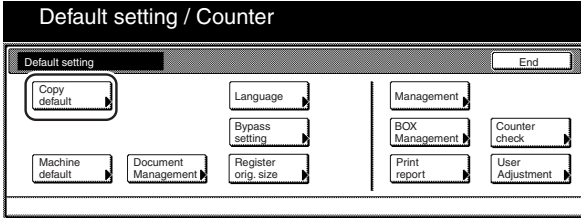

Metric specifications

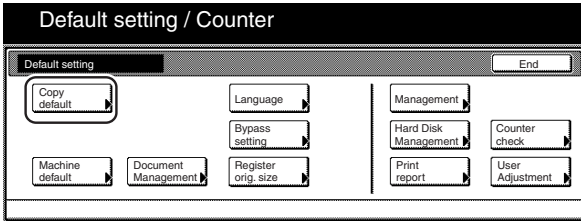

- 2 Select "Preset limit" in the settings list on the left side of the touch panel and then touch the "Change #" key. The "Preset limit" screen will be displayed.

Inch specifications

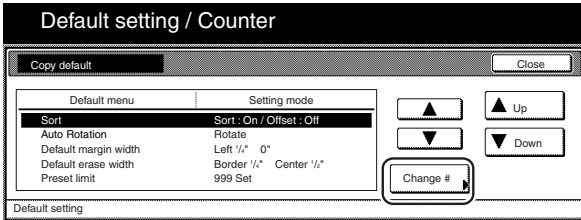

Metric specifications

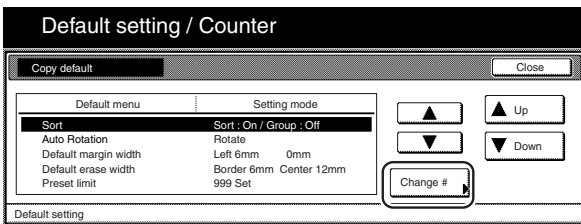

- 3 Touch the "+" key or the "-" key to change the copy limit to the desired setting.

Inch specifications

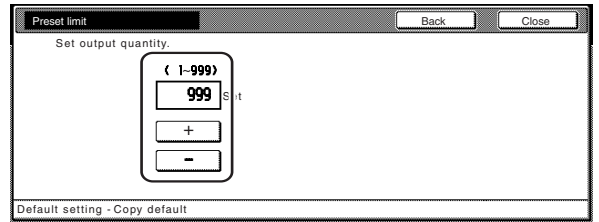

Metric specifications

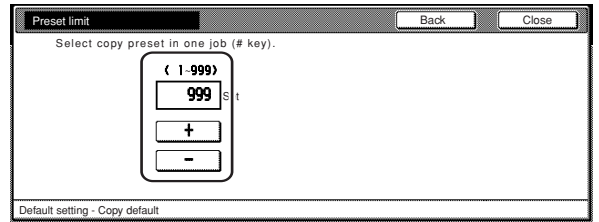

NOTE

If you want to quit the displayed setting without changing it, touch the "Back" key. The touch panel will return to the screen in step 2.

- 4 Touch the "Close" key. The touch panel will return to the screen in step 2.

- 5 Touch the "Close" key once again. The touch panel will return to the "Default setting" screen.

- 6 Touch the "End" key. The touch panel will return to the contents of the "Basic" tab.

● Repeat copying ON/OFF

Perform the following procedure to set whether or not to prohibit repeat copying, as well as whether or not to make repeat copying the default setting in the initial mode.

NOTE

This setting is displayed when the optional Hard Disk is installed.

- 1 Display the "Copy default" screen. (See "(5) Accessing the copy default settings" on page 7-62.)

Inch specifications

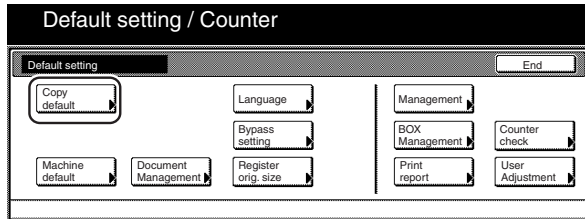

Metric specifications

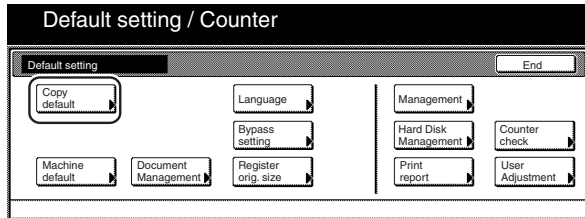

- 2 Select "Modify Copy" in the settings list on the left side of the touch panel and then touch the "Change #" key. The "Modify Copy" screen will be displayed.

Inch specifications

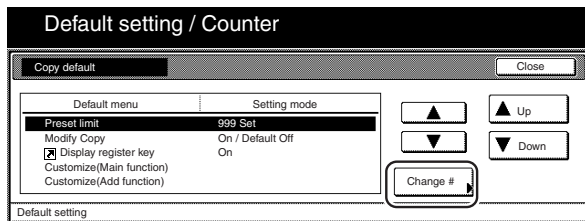

Metric specifications

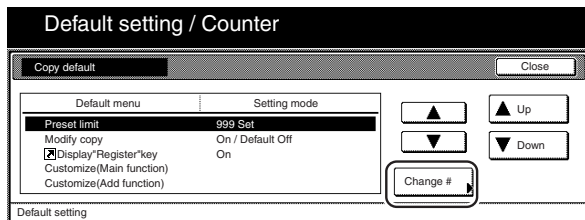

- 3 If you want to prohibit repeat copying, touch the "Off" key. If you want to make repeat copying the default setting in the initial mode, touch the "On" key.

Inch specifications

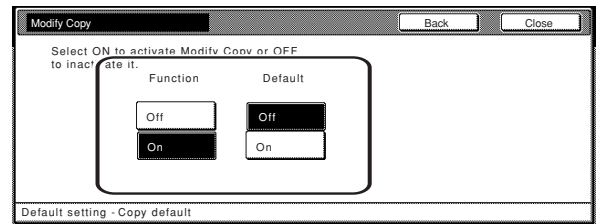

Metric specifications

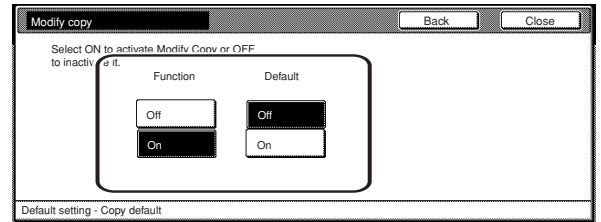

NOTE

If you want to quit the displayed setting without changing it, touch the "Back" key. The touch panel will return to the screen in step 2.

- 4 Touch the "Close" key. The touch panel will return to the screen in step 2.
- 5 Touch the "Close" key once again. The touch panel will return to the "Default setting" screen.
- 6 Touch the "End" key. The touch panel will return to the contents of the "Basic" tab.

Section 7 COPIER MANAGEMENT FUNCTIONS

● Registration keys ON/OFF

Perform the following procedure to set whether or not to allow a “Register” key to be displayed in the screen for those function and modes which can be registered under the registration keys. Functions and/or modes can only be registered under registration keys through the “Register” key.

- 1 Display the “Copy default” screen.
(See “(5) Accessing the copy default settings” on page 7-62.)

Inch specifications

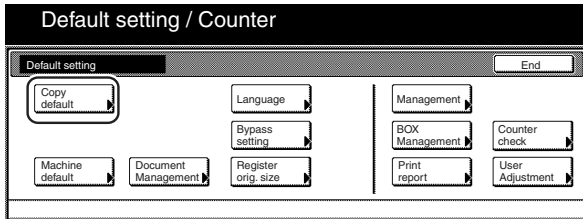

Metric specifications

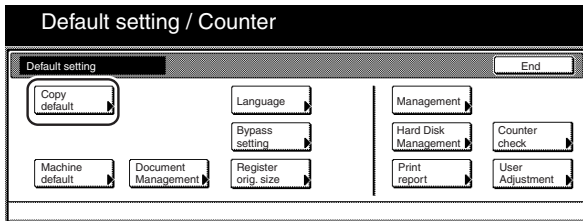

- 2 Select “Display register key” [“Display “Register” key”] in the settings list on the left side of the touch panel and then touch the “Change #” key.
The “Display register key” [“Display “Register” key”] screen will be displayed.

Inch specifications

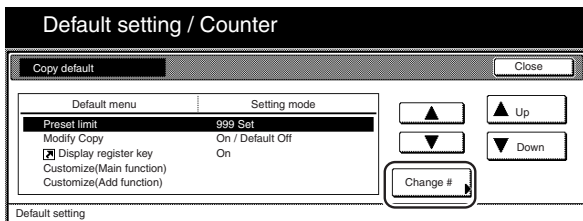

Metric specifications

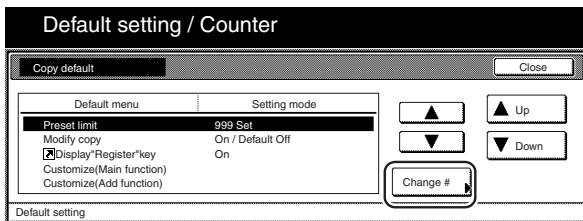

- 3 If you want the “Register” key to be displayed, touch the “On” key. If you do NOT want it to be displayed, touch the “Off” key.

Inch specifications

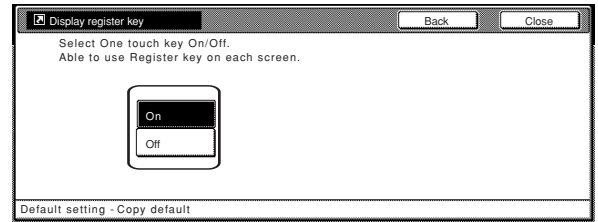

Metric specifications

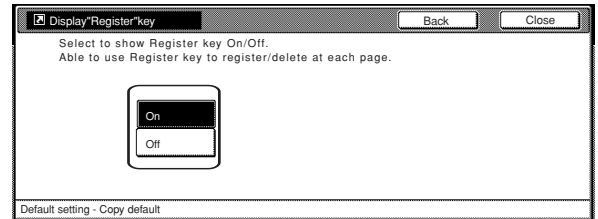

NOTE

If you want to quit the displayed setting without changing it, touch the “Back” key. The touch panel will return to the screen in step 2.

- 4 Touch the “Close” key. The touch panel will return to the screen in step 2.
- 5 Touch the “Close” key once again. The touch panel will return to the “Default setting” screen.
- 6 Touch the “End” key. The touch panel will return to the contents of the “Basic” tab.

● **Customize screen layout (Main functions)**

Perform the following procedure to change the order of the main functions and modes that are displayed in the “Basic” and the “User choice” tabs in order to make the display more appropriate to the way you use the copier.

- 1 Display the “Copy default” screen. (See “(5) Accessing the copy default settings” on page 7-62.)

Inch specifications

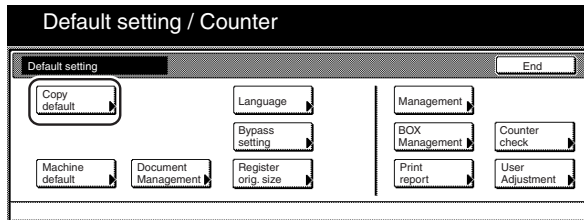

Metric specifications

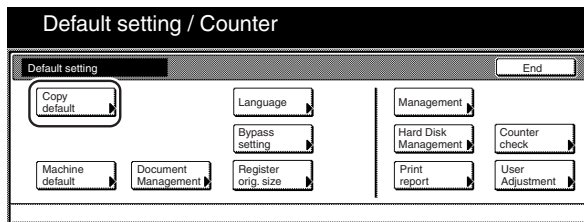

- 2 Select “Customize(Main function)” in the settings list on the left side of the touch panel and then touch the “Change #” key.

The “Customize(Main function)” screen will be displayed.

Inch specifications

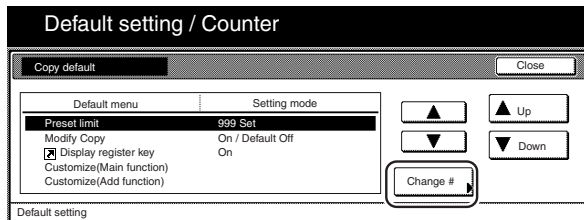

Metric specifications

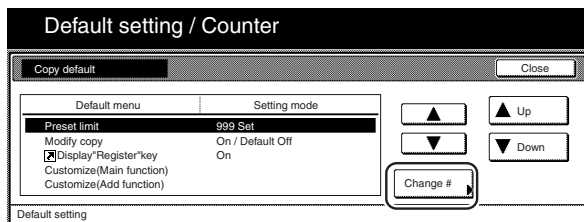

- 3 If you want to change the order of the basic functions and modes, touch the “▲” or the “▼” cursor key to select the item you want to move. Then touch the “Move ahead” key or the “Move behind” [“Move backward”] key to move that item and change the order of display. The final display of the basic functions and modes will be in accordance with the numbers in the list and those shown in the tabs to the left of that list.

Inch specifications

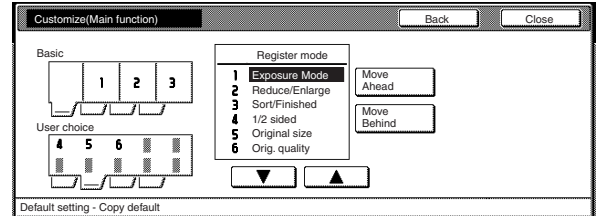

Metric specifications

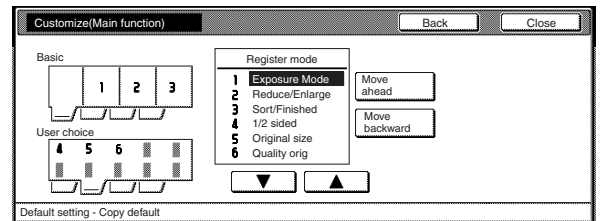

NOTE

If you want to quit the displayed setting without changing it, touch the “Back” key. The touch panel will return to the screen in step 2.

- 4 Touch the “Close” key. The touch panel will return to the screen in step 2.
- 5 Touch the “Close” key once again. The touch panel will return to the “Default setting” screen.
- 6 Touch the “End” key. The touch panel will return to the contents of the “Basic” tab.

Section 7 COPIER MANAGEMENT FUNCTIONS

● Customize screen layout (Add functions)

Perform the following procedure to add often-used functions and/or modes, or to change the order of their layout, in order to make the display more appropriate to the way you use the copier.

- 1 Display the "Copy default" screen.
(See "(5) Accessing the copy default settings" on page 7-62.)

Inch specifications

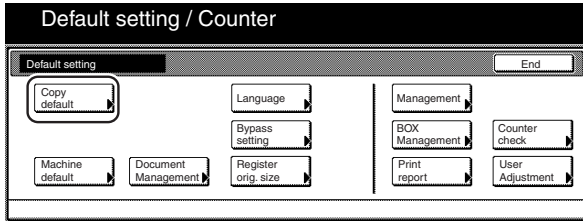

Metric specifications

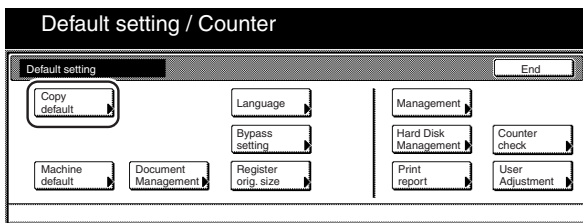

- 2 Select "Customize(Add function)" in the settings list on the left side of the touch panel and then touch the "Change #" key.

The "Customize(Add function)" screen will be displayed.

Inch specifications

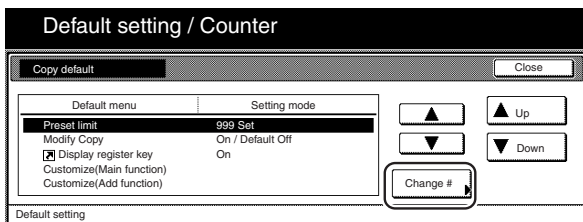

Metric specifications

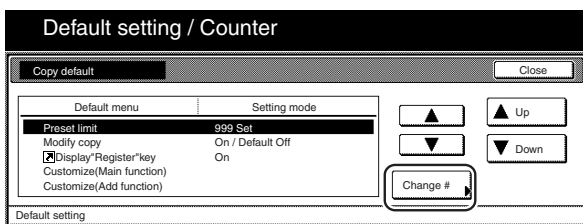

- 3 If you want to add functions and/or modes to the "User choice" tab, touch the "▲" or the "▼" cursor key under the list on the right to select the item you want to add. Then touch the "▲" or the "▼" cursor key under the list on the left to select in what order you want it to be added in that tab. Finally, touch the "←" key to add the selected item to the "User choice" tab.

Inch specifications

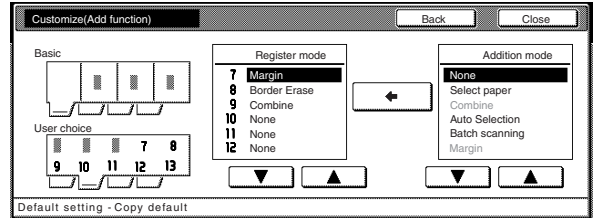

Metric specifications

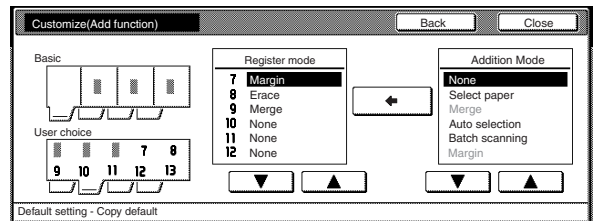

NOTE

If you want to quit the displayed setting without changing it, touch the "Back" key. The touch panel will return to the screen in step 2.

- 4 Touch the "Close" key. The touch panel will return to the screen in step 2.
- 5 Touch the "Close" key once again. The touch panel will return to the "Default setting" screen.
- 6 Touch the "End" key. The touch panel will return to the contents of the "Basic" tab.

3. Multi-bypass tray paper settings

(1) Paper size and type

Perform the following procedure in order to use the multi-bypass tray to feed copy paper.

- With the content of the "Basic" tab displayed, press the [Default Setting/Counter] key. The "Default setting" screen will be displayed.

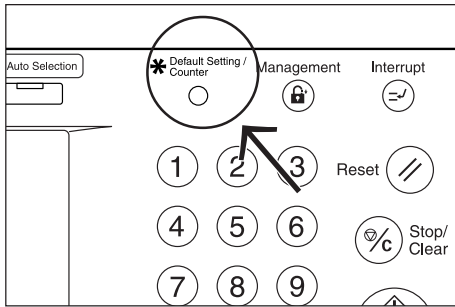

- Touch the "Bypass setting" key. The "Bypass setting" screen will be displayed.

Inch specifications

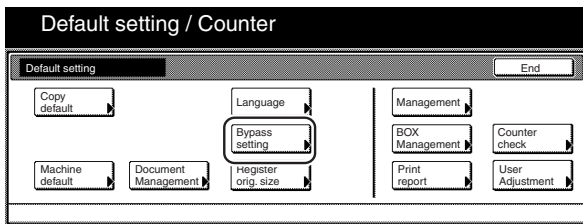

Metric specifications

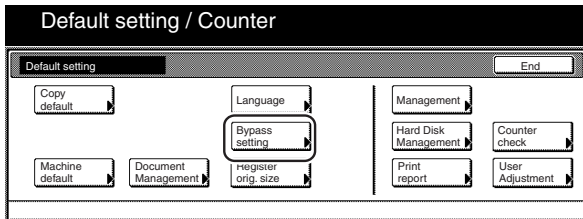

- Specify the desired method of selecting the paper size. If you select "Auto Detection" here, select the desired unit of measure ("Centimeter" or "Inch") as well, and then go directly to step 5. If you want to select a custom paper size, touch the "Input size" and then go to the next step.

Inch specifications

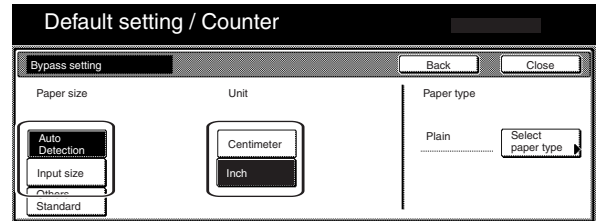

Metric specifications

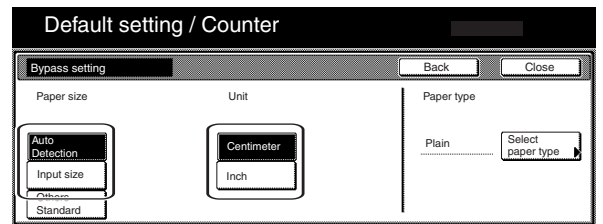

- Touch the "+" key or the "-" key to change each of the displayed sizes (length and width) to the desired settings.
 - * In metric specification copiers, the desired sizes can also be entered directly by touching the corresponding "#-Keys" key and then using the keypad.

Inch specifications

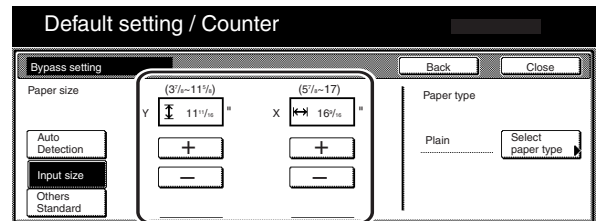

Metric specifications

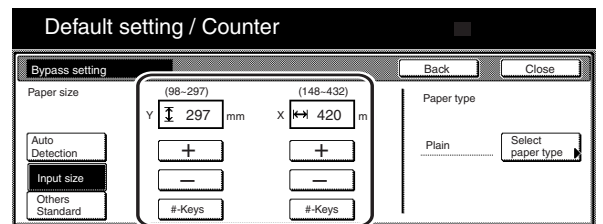

Section 7 COPIER MANAGEMENT FUNCTIONS

- 5 Touch the "Select paper type" key.
The "Select paper type" screen will be displayed.

- 6 Touch the key that corresponds to the type of paper to be used, and then touch the "Close" key. The touch panel will return to the screen in step 4.

Inch specifications

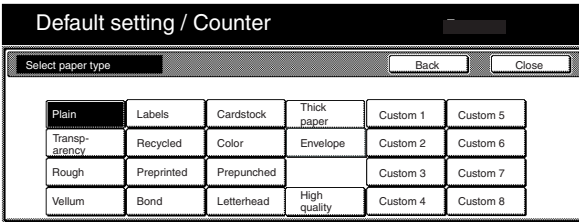

Metric specifications

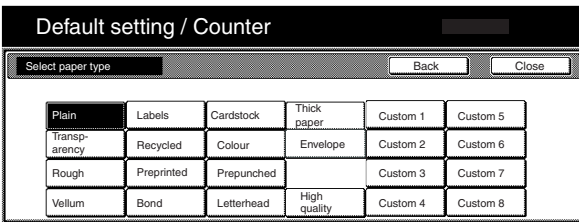

- 7 Touch the "Close" key once again. The touch panel will return to the screen in step 2. Touch the "End" key. The touch panel will return to the contents of the "Basic" tab.

(2) Selecting other standard sizes

Perform the following procedure when you want to print out onto other standard sizes of special paper.

- 1 With the content of the "Basic" tab displayed, press the [Default setting/Counter] key.
The "Default setting" screen will be displayed.

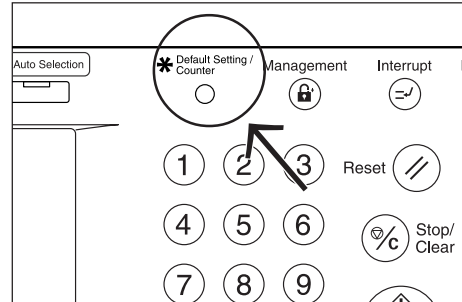

- 2 Touch the "Bypass setting" key.
The "Bypass setting" screen will be displayed.

Inch specifications

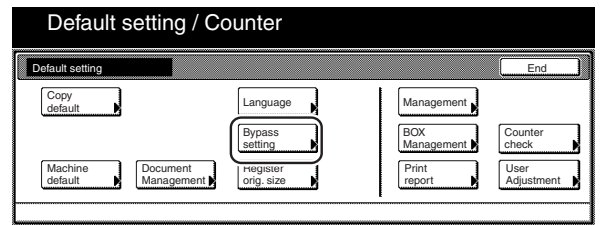

Metric specifications

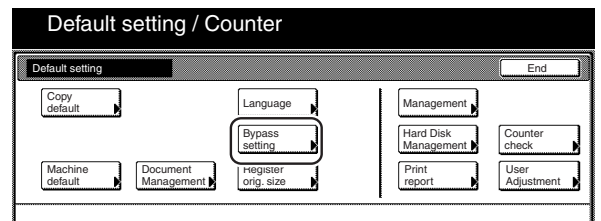

- 3 Touch the "Others Standard" key.

Inch specifications

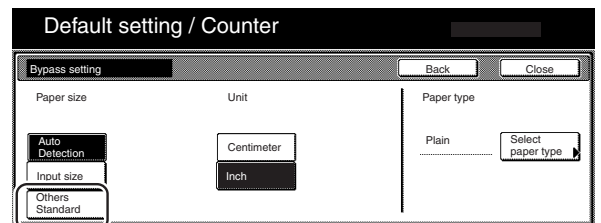

Metric specifications

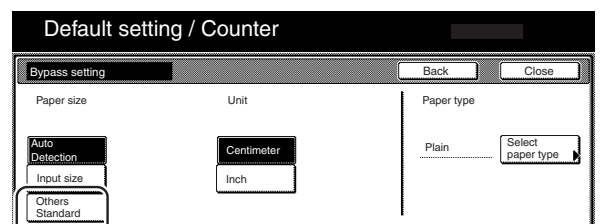

- 4** Touch the “Select size” key. The “Select size” screen will be displayed.

Inch specifications

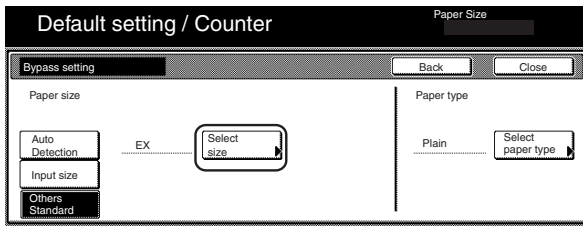

Metric specifications

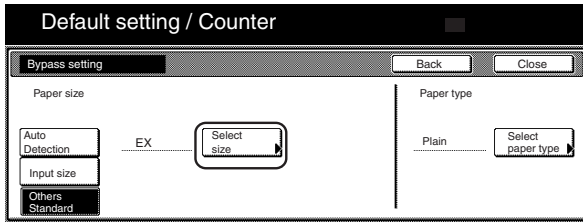

- 5** Touch the key that corresponds to the size of paper you want to use, and then touch the “Close” key. The touch panel will return to the screen in step 4.

Inch specifications

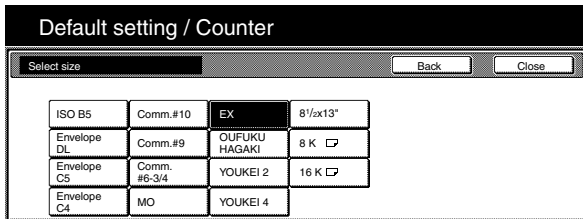

Metric specifications

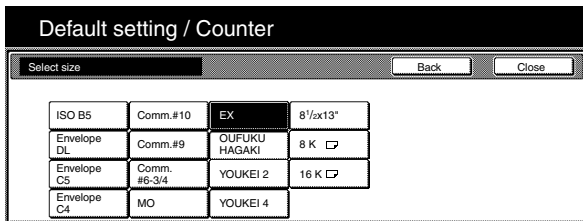

- 6** Touch the “Select paper type” key. The “Select paper type” screen will be displayed. Touch the key that corresponds to the type of paper you want to use, and then touch the “Close” key. The touch panel will return to the screen in step 4.

Inch specifications

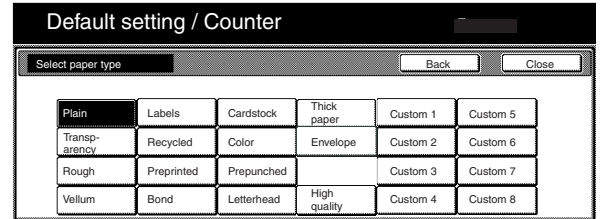

Metric specifications

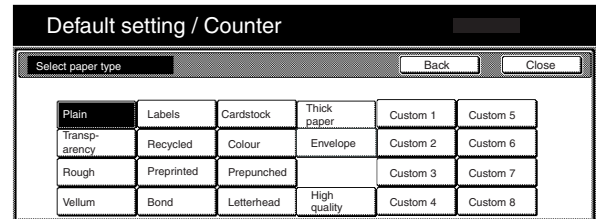

- 7** Touch the “Close” key. The touch panel will return to the screen in step 2. Touch the “End” key. The touch panel will return to the contents of the “Basic” tab.

4. Original size registration

Perform the following procedure in order to register a custom original size that can be used under the “Original size selection” procedure.

- 1 With the content of the “Basic” tab displayed, press the [Default Setting/Counter] key. The “Default setting” screen will be displayed.

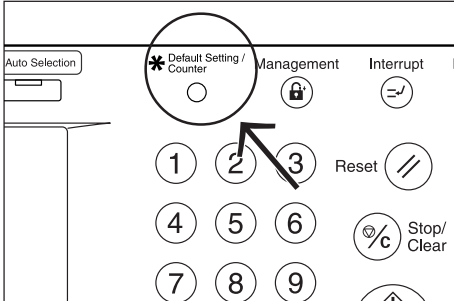

- 2 Touch the “Register orig. size” key. The “Register orig. size” screen will be displayed.

Inch specifications

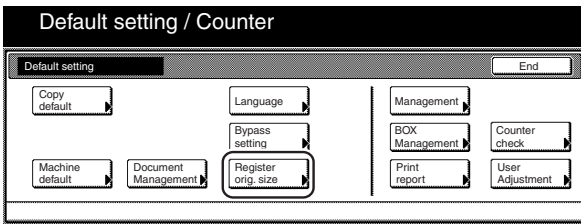

Metric specifications

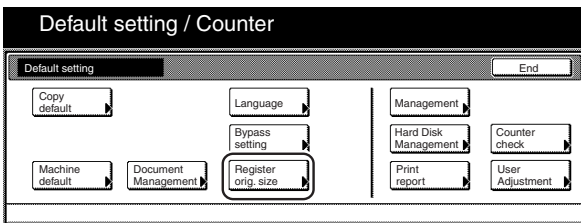

- 3 Select of the “Original size (custom 1)” to “Original size (custom 4)” settings under the “Default menu” column on the left side of the touch panel and then touch the “Change #” key.

The corresponding setting screen will be displayed.

Inch specifications

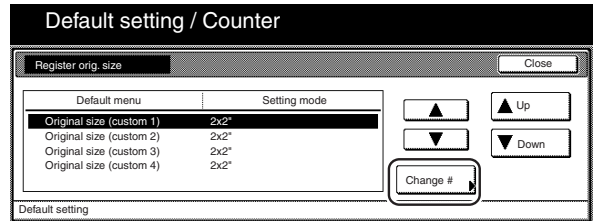

Metric specifications

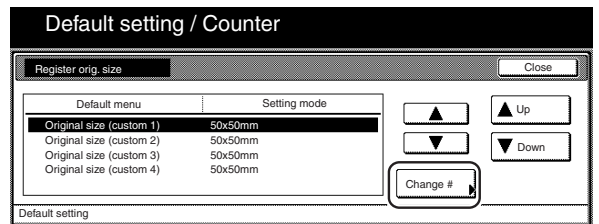

- 4 Touch the “+” key or the “-” key to change each of the displayed sizes (Y = width and X = length) to the desired settings.

If you do not want to register a custom original size, touch the “Off” key.

Inch specifications

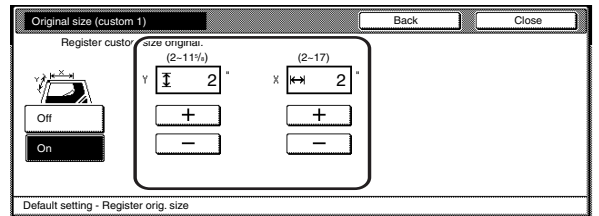

Metric specifications

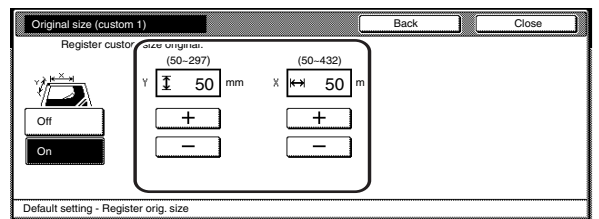

- 5 Touch the “Close” key. The touch panel will return to the screen in step 3.

- 6 Touch the “Close” key. The touch panel will return to the screen in step 2. Touch the “End” key. The touch panel will return to the contents of the “Basic” tab.

5. Drum refresh

Perform the following procedure if the copy image becomes blurred or if white spots which are not on the originals appear on the copies. The drum refreshing operation will take approximately 5 minutes.

- 1 Set 11" x 8 1/2", 11" x 17", A4 or A3 size paper on the multi-bypass tray.
- 2 With the content of the "Basic" tab displayed, press the [Default Setting/Counter] key. The "Default setting" screen will be displayed.

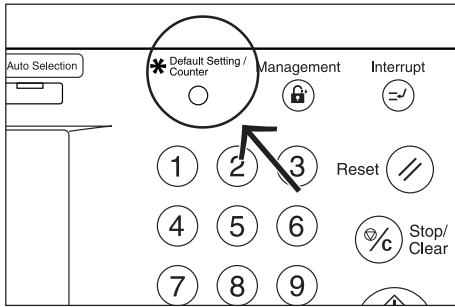

- 3 Touch the "User adjustment" key.
Inch specifications

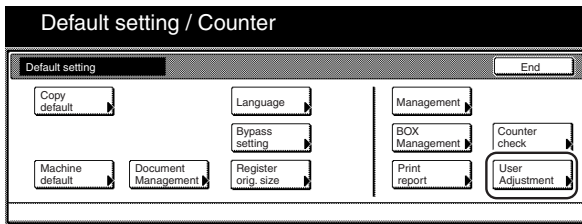

Metric specifications

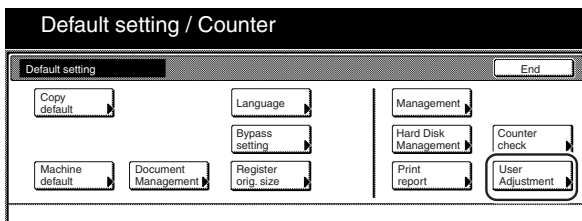

- 4 Touch the "Drum refresh" key. The "Drum refresh" screen will be displayed.

Inch specifications

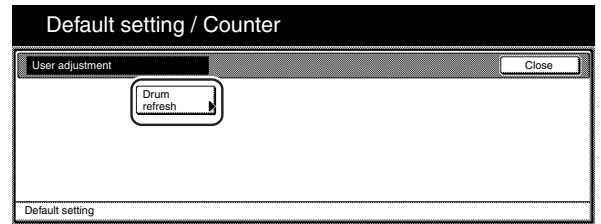

Metric specifications

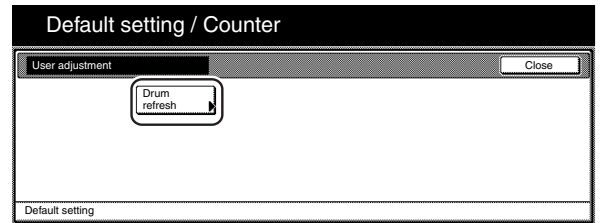

Section 7 COPIER MANAGEMENT FUNCTIONS

- 5** Touch the “On” key. The drum refreshing process will begin.

Inch specifications

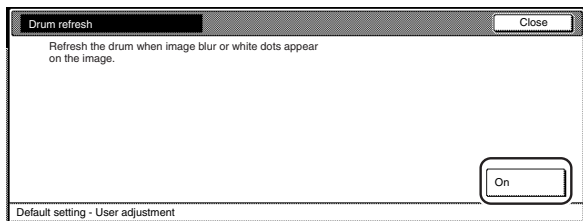

Metric specifications

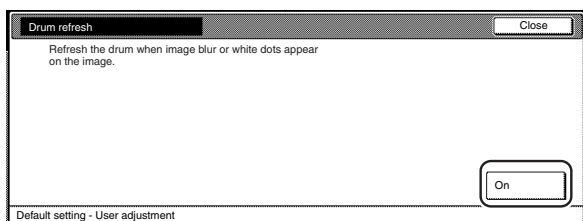

The “Now drum refreshing.” message will appear and the paper is fed from the multi-bypass tray to execute drum refreshing.

Inch specifications

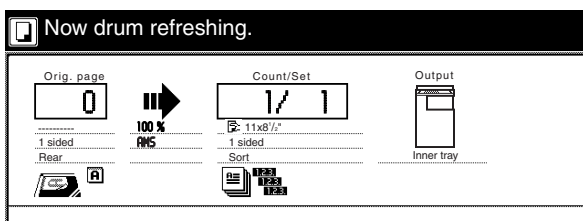

Metric specifications

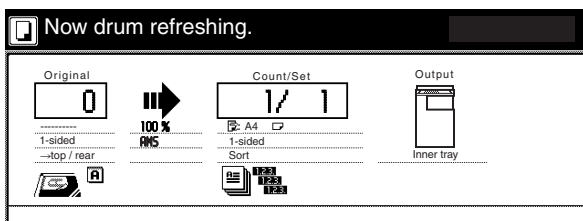

NOTE

To cancel drum refreshing, press the [Stop/Clear] key.

When drum refreshing completes after ejecting the paper, the touch panel will return to the “Drum refresh” screen.

- 6** Touch the “Close” key.
The touch panel will return to the screen in step 4.
- 7** Touch the “Close” key.
The touch panel will return to the screen in step 3.
- 8** Touch the “End” key.
The touch panel will return to the contents of the “Basic” tab.

6. Checking the total counter and printing out the counter report

Perform this procedure when you want to check, on the touch panel, the total count of copies, etc., made on this machine as a whole. You can also print out the information as a counter report.

NOTES

- You can also check the total number of printouts made under each of the optional printer, scanner a fax functions.
- You can additionally check the number of originals scanned on this machine.

- 1 With the content of the “Basic” tab displayed, press the [Default Setting/Counter] key. The “Default setting” screen will be displayed.

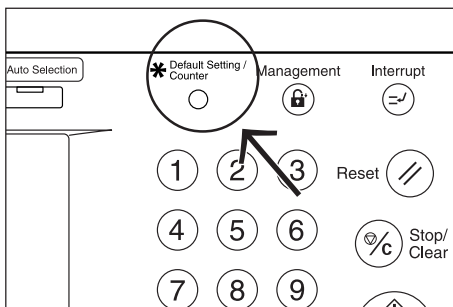

- 2 Touch the “Counter check” key. The “Counter check” screen will be displayed.

Inch specifications

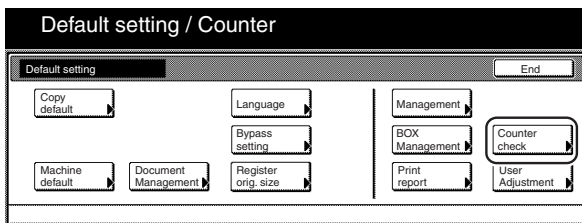

Metric specifications

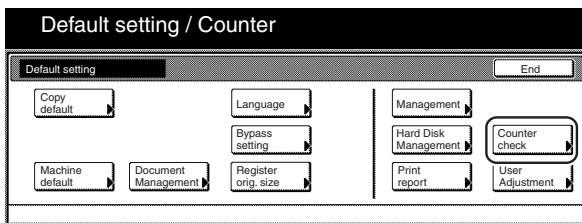

- 3 The total number of copies and printouts made will be displayed. If you want to print out a counter report, touch the “Print report” key.

Inch specifications

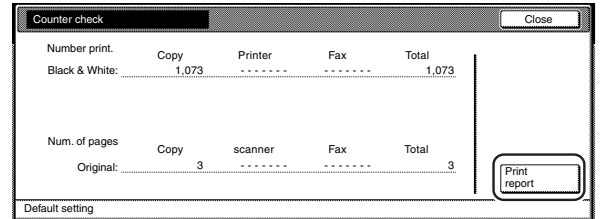

Metric specifications

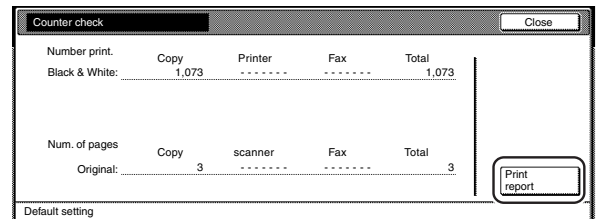

NOTE

Make sure there is 11" x 8 1/2" [A4] size paper loaded in one of the drawers[cassettes] when you print out the counter report.

- 4 Once you are finished checking the counts, touch the “Close” key. The touch panel will return to the screen in step 2.

Inch specifications

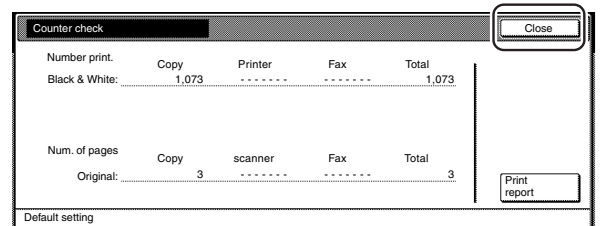

Metric specifications

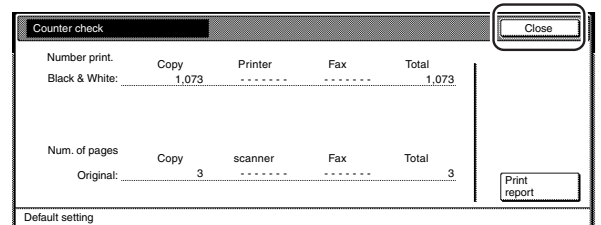

- 5 Touch the “End” key. The touch panel will return to the contents of the “Basic” tab.

7. Box management default settings

Perform the following settings in order to manage the “boxes” that are used under the document management functions.

NOTE

This setting is displayed when the optional Hard Disk is installed.

(1) Box settings

| Setting | Description | Reference page |
|---|---|----------------|
| ● Document list print out | This procedure will allow you to print out a list of all of the images stored in the box for the form overlay mode, of the documents stored in the shared data box or of the documents stored in the synergy print boxes. | 7-95 |
| ● Reset box | This procedure will delete all of the image data that is stored in the “Form” box, as well as the documents stored in the shared data box and the synergy print boxes. Make absolutely certain that you do not need the corresponding data before you attempt to delete it. | 7-96 |
| ● Box name & password / Clear data in box | This procedure will allow you to change the name and password for any one of the synergy print boxes as well as delete at one time all of the data registered in any one box. If you register a password for any of these boxes, you will need to enter the registered password in order to print out or delete any documents that are stored win that box. | 7-97 |
| ● Document save time | This procedure will allow you to select the length of time that will elapse before each job in a synergy print box is automatically deleted. Set this time to any number of days between 1 and 7. * This setting cannot be made independently for each box. | 7-98 |

(2) Accessing the box management default settings

Perform the following procedure when you want to access the “Document Management” screen for each of the various box management default settings.

- With the content of the “Basic” tab displayed, press the [Default Setting/Counter] key. The “Default setting/Counter” screen will be displayed.

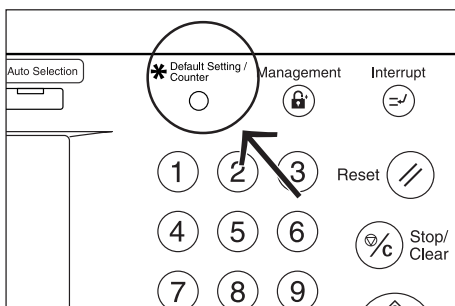

- Touch the “Document Management” key.

Inch specifications

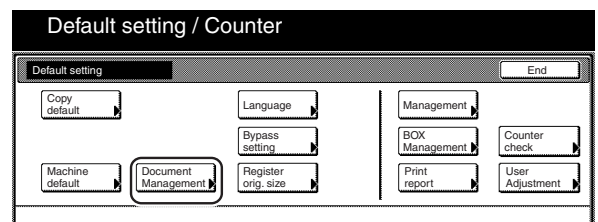

Metric specifications

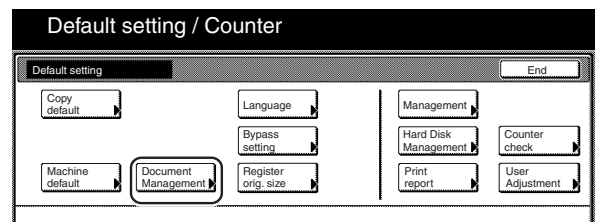

- Use the keypad to enter the 4-digit management code. The factory default setting for 30 cpm copiers is "3000", for 40 cpm copiers is "4000" and for 50 cpm copiers is "5000". If the entered code matched the registered one, the "Document Management" screen will be displayed.

Inch specifications

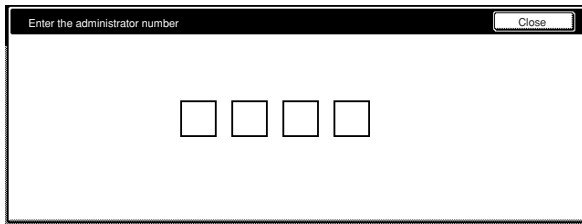

Metric specifications

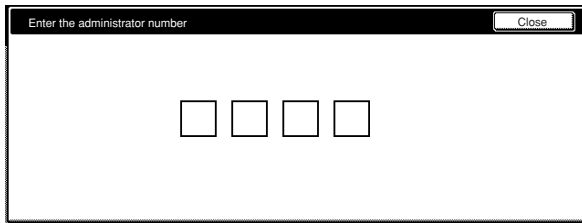

- Touch the key that corresponds to the desired box management default setting.

Inch specifications

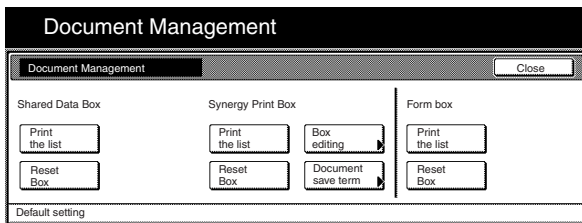

Metric specifications

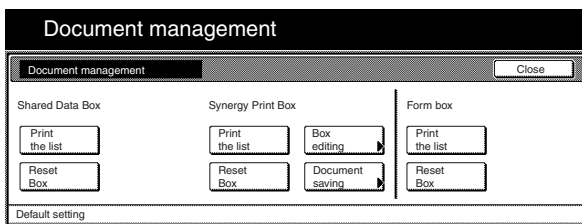

(3) Making box management default settings

Perform the following procedure that corresponds to the desired setting.

● Document list print out

- Touch the "Print the list" key under the box ("Form Box", "Shared Data Box" or "Synergy Print Box") for which you want to print out the document list.

Inch specifications

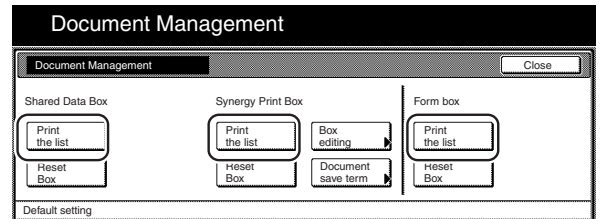

Metric specifications

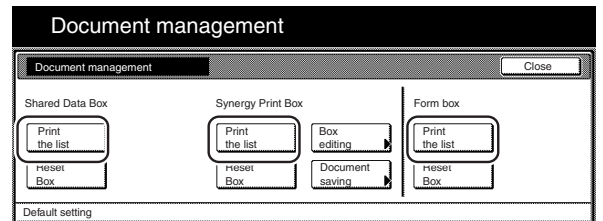

- A document list will be printed out for that box. once print out is completed, the touch panel will return to the screen in step 1.

- Touch the "Close" key. The touch panel will return to the "Default setting" screen. Touch the "End" key. The touch panel will return to the contents of the "Basic" tab.

NOTES

- It is possible for you to change the 4-digit management code. (See "Changing the management code" on page 7-56.)
- Refer to the desired procedure(s) explained under "(3) Making box management default settings" and perform the corresponding setting(s).

Section 7 COPIER MANAGEMENT FUNCTIONS

● Reset box

- 1 Touch the "Reset Box" key under the box ("Form Box", "Shared Data Box" or "Synergy Print Box") that you want to delete all data for.
A verification screen will be displayed.

Inch specifications

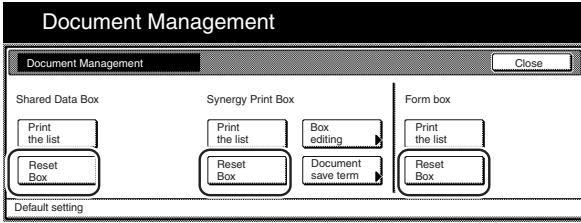

Metric specifications

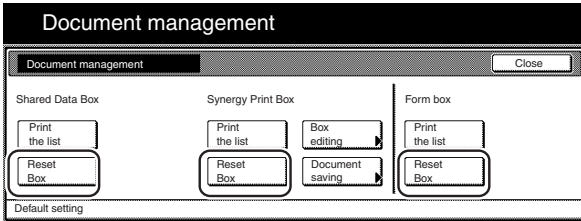

- 2 Touch the "Yes" key or the "No" key, as appropriate.

Inch specifications

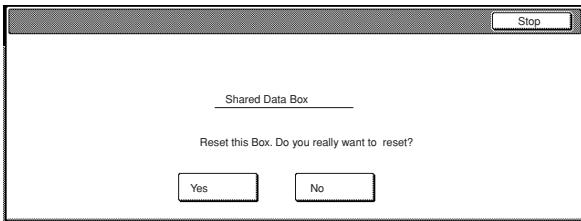

Metric specifications

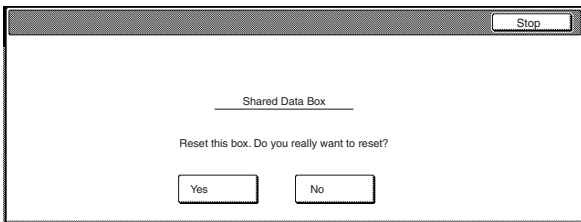

If you selected "Yes", all the data in the selected box will be deleted and the touch panel will return to the screen in step 1. If you selected "No", the touch panel will return to the screen in step 1 without deleting any data.

- 3 Touch the "Close" key. The touch panel will return to the "Default setting" screen. Touch the "End" key. The touch panel will return to the contents of the "Basic" tab.

● Box name & password / Clear data in box

- 1 Touch the "Box editing" key under "Synergy Print Box". The "Box editing" screen will be displayed.

Inch specifications

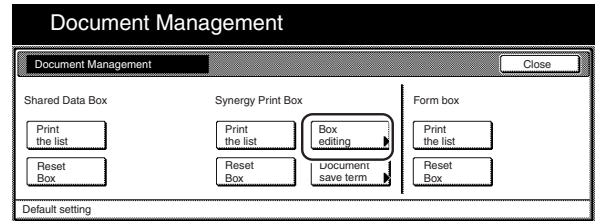

Metric specifications

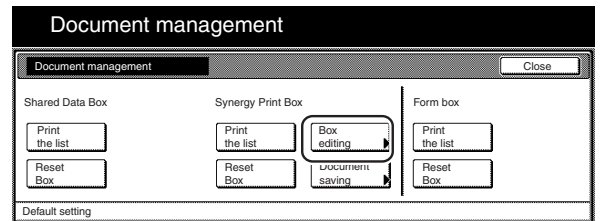

- 2 Either touch the synergy print box that contains the information to be modified, or enter its number using the keypad. Then touch the "Enter" key.

Inch specifications

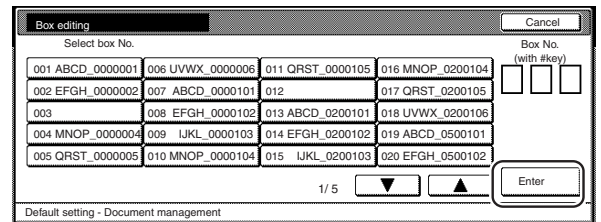

Metric specifications

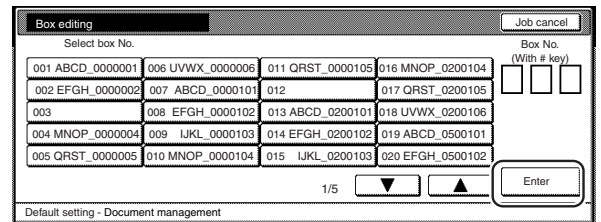

- If you want to change the name of that box, first select “Box name” and then touch the “Change #” key. Enter the new name as desired.

Inch specifications

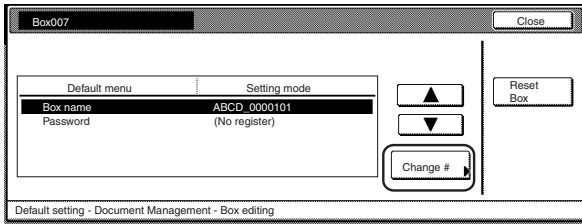

Metric specifications

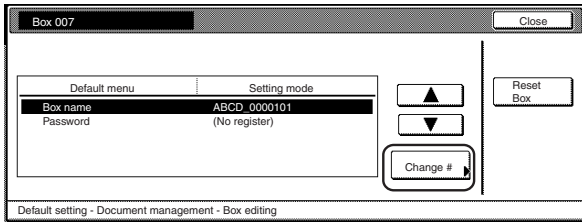

NOTE

Refer to “11. Entering characters” on page 7-104 for information on entering characters.

- If you want to change the name of that box, first select “Password” and then touch the “Change #” key. The “Password” screen will be displayed.
- Use the keypad to enter the new password for that box and then touch the “Close” key. The new password will be registered and the touch panel will return to the screen in step 3.

Inch specifications

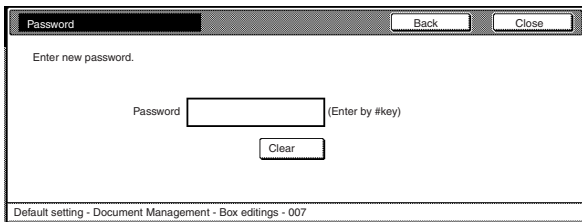

Metric specifications

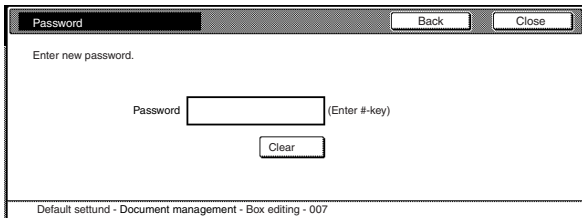

NOTES

- The password can be between 1 and 8 digits long.
- If you decide not to register a password for that box, touch the “Clear” key and then, with nothing entered in the password field, touch the “Close” key.

- If you want to delete all of the data in that box, select “Reset Box”. A verification screen will be displayed.
- Touch the “Yes” key or the “No” key, as appropriate.

Inch specifications

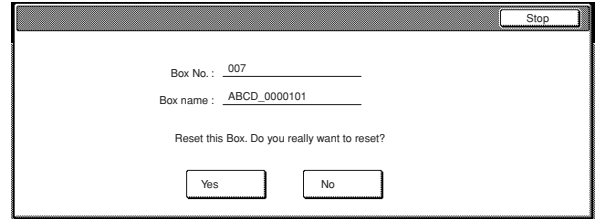

Metric specifications

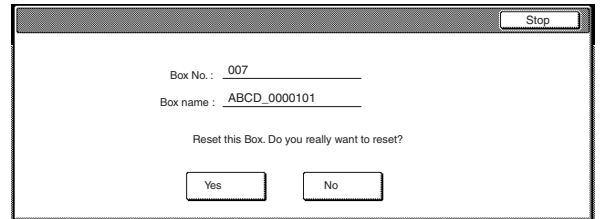

If you selected “Yes”, all the data in the selected box will be deleted and the touch panel will return to the screen in step 3.

If you selected “No”, the touch panel will return to the screen in step 3 without deleting any data.

- Touch the “Close” key. The touch panel will return to the screen in step 2.
- Touch the “Close” key. The touch panel will return to the screen in step 1. Touch the “Close” key. The touch panel will return to the “Default setting” screen. Touch the “End” key. The touch panel will return to the contents of the “Basic” tab.

Section 7 COPIER MANAGEMENT FUNCTIONS

● Document save time

- 1 Touch the “Document save term” [“Document saving”] key under “Synergy Print Box”. The “Document data saving term” [“Document data save period”] screen will be displayed.

Inch specifications

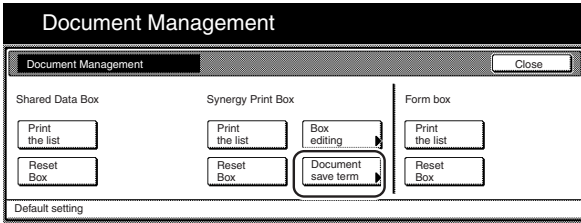

Metric specifications

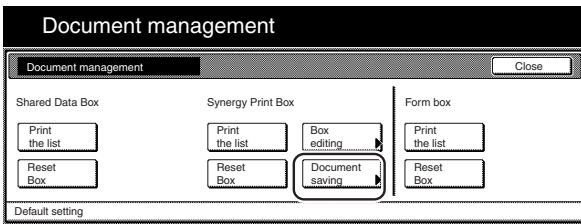

- 2 Touch the “Set save term” [“Set save period”] key and then touch “+” key or the “-” key to change the displayed save time to the desired setting.

Inch specifications

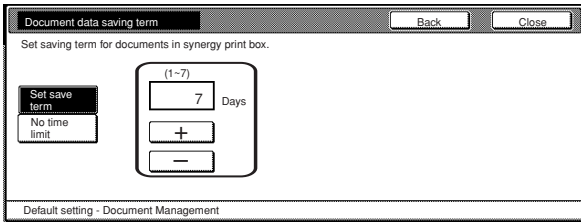

Metric specifications

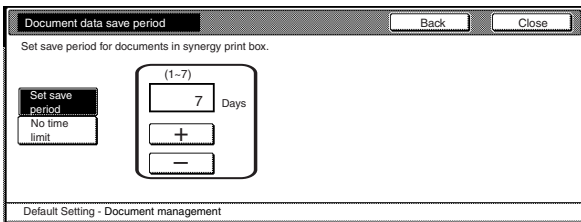

NOTES

- The save time can be set to any number of days between 1 and 7. The factory default setting is for “7 Days”.
- If you want the data to be saved indefinitely, touch the “No time limit” key to highlight it.

- 3 Touch the “Close” key. The touch panel will return to the screen in step 1.

- 4 Touch the “Close” key once again. The touch panel will return to the “Default setting” screen. Touch the “End” key. The touch panel will return to the contents of the “Basic” tab.

8. Hard disk management

Perform the following procedure to access the “HDD management mode” screen and check available space and/or delete any invalid data on the optional Hard Disk.

- 1 With the content of the “Basic” tab displayed, press the [Default setting/Counter] key.
The “Default setting” screen will be displayed.

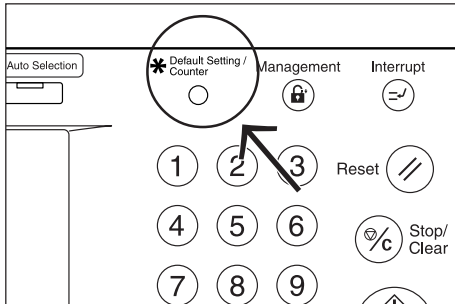

- 2 Touch the “BOX Management” [“Hard Disk Management”] key.

Inch specifications

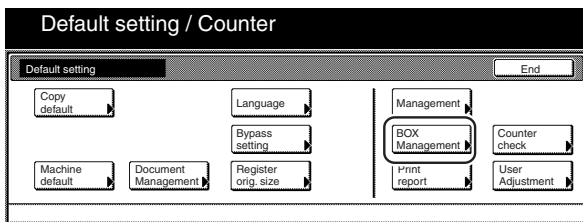

Metric specifications

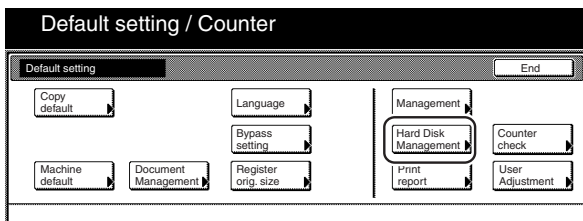

- 3 Use the keypad to enter the 4-digit management code.
The factory default setting for 30 cpm copiers is “3000”, for 40 cpm copiers is “4000” and for 50 cpm copiers is “5000”.
If the entered code matched the registered one, the “HDD Management mode” [“HDD Management”] screen will be displayed.

Inch specifications

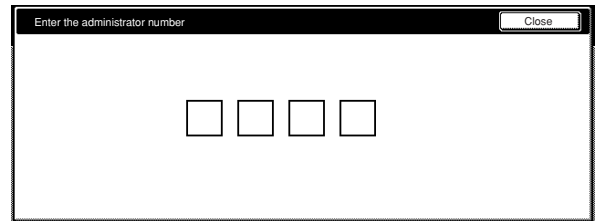

Metric specifications

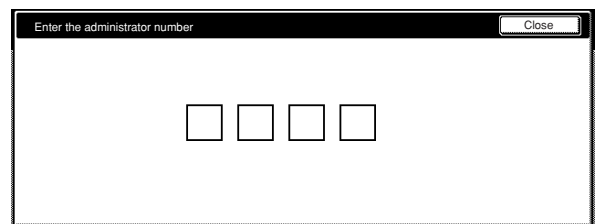

- 4 Touch the “On” key under “Check HDD capacity” (left side of the touch panel). The overall size of the hard disk, as well as the currently available space, will be displayed. If you want to delete any invalid data, go to the next step. If you are finished with this procedure, go directly to step 6.

Inch specifications

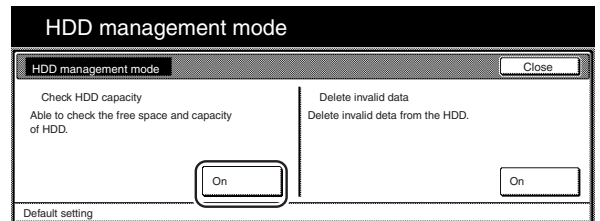

Metric specifications

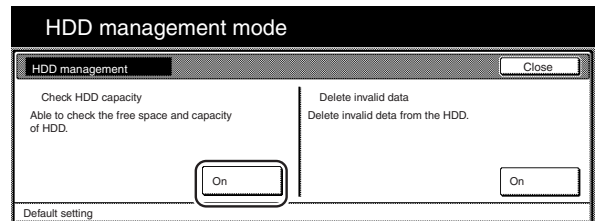

Section 7 COPIER MANAGEMENT FUNCTIONS

- 5 Touch the “On” key under “Delete invalid data” (right side of the touch panel). The operation to delete invalid data will start.

Inch specifications

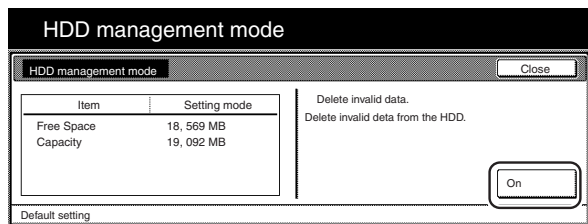

Metric specifications

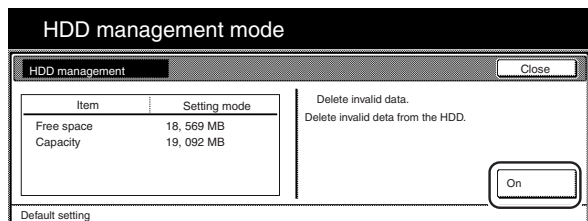

- 6 Touch the “Close” key. The touch panel will return to the screen in step 2. Touch the “End” key. The touch panel will return to the contents of the “Basic” tab.

9. Report print out

Perform the following procedure to print out one of the following reports.

< Copy report >

Lists all of the values for the copy default settings.

< Machine report >

Lists all of the values for the machine default settings.

< Toner coverage report >

Lists the average toner density (black ratio) for each size of copy paper used under each of the copy, printer and fax functions of this machine.

NOTE

Make sure that 11" x 8 1/2" [A4] size paper is loaded in one of the drawers[cassettes].

- 1 With the content of the "Basic" tab displayed, press the [Default Setting/Counter] key. The "Default setting" screen will be displayed.

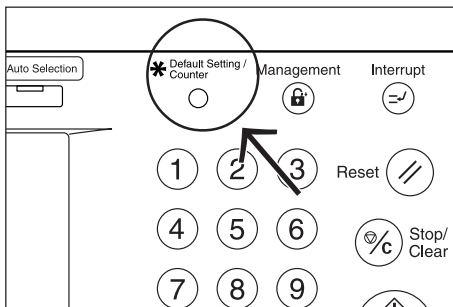

- 2 Touch the "Print report" key.

Inch specifications

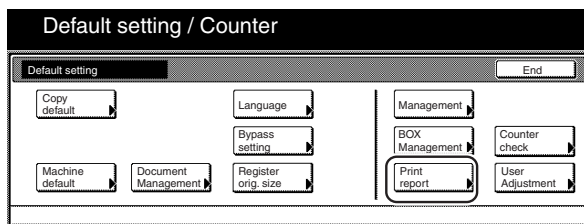

Metric specifications

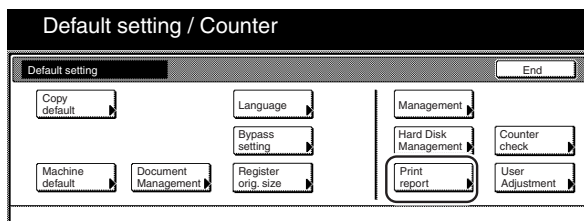

- 3 Use the keypad to enter the 4-digit management code. The factory default setting for 30 cpm copiers is "3000", for 40 cpm copiers is "4000" and for 50 cpm copiers is "5000".

Inch specifications

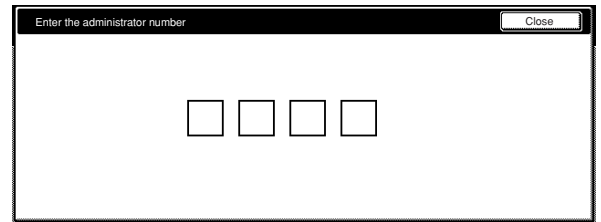

Metric specifications

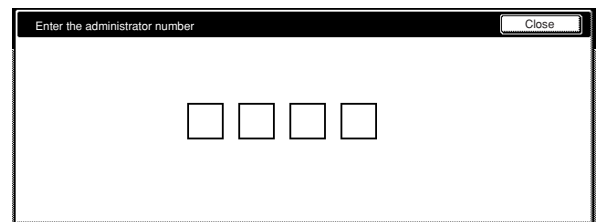

NOTE

It is possible for you to change the 4-digit management code. (See "Changing the management code" on page 7-56.)

- 4 Once the "Print report menu" screen is displayed, touch the "Copy report" key, the "Machine report" key or the "Toner coverage" key, as appropriate.

Inch specifications

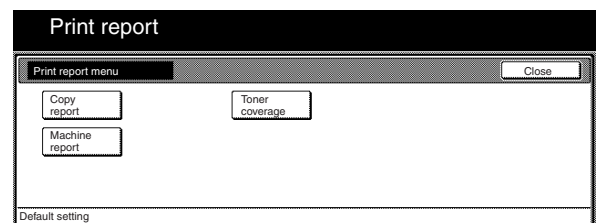

Metric specifications

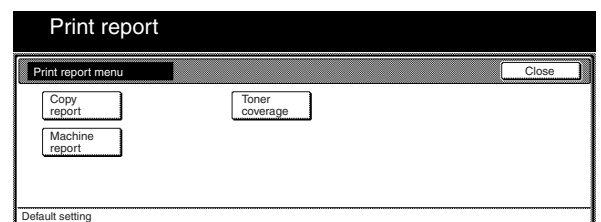

Section 7 COPIER MANAGEMENT FUNCTIONS

- 5 The "Printing report" screen will be displayed and printing of the corresponding report will start.

Inch specifications

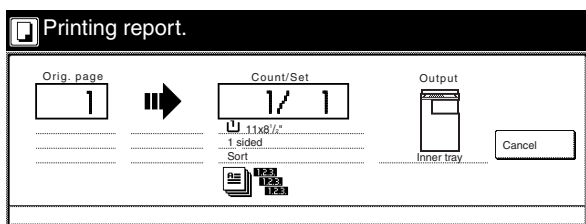

Metric specifications

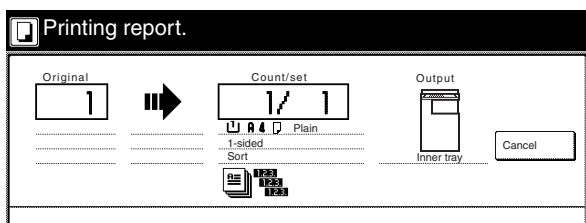

NOTE

If you want to cancel print out of the corresponding report, touch the "Cancel" key.

When the report is complete, the touch panel will return to the screen in step 4.

- 6 Touch the "Close" key. The touch panel will return to the screen in step 2.

- 7 Touch the "End" key. The touch panel will return to the contents of the "Basic" tab.

10. Changing the language used for messages

You can select the language that will be used on the touch panel.

The available languages are as follows:

Inch specification copiers:

English, French (“Français”), Spanish (“Español”) and Japanese (“日本語”)

Metric specification copiers:

English, German (“DEUTSCH”), French (“FRANÇAIS”), Italian (“ITALIANO”) and Spanish (“ESPAÑOL”)

- 1 With the content of the “Basic” tab displayed, press the [Default Setting/Counter] key. The “Default setting/Counter” screen will be displayed.

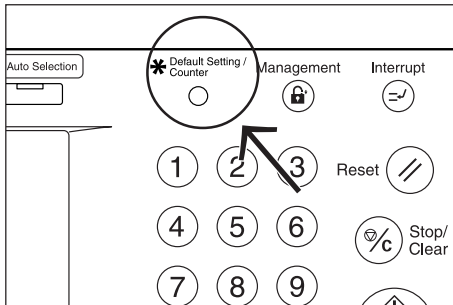

- 2 Touch the “Language” key. The “Language” screen will be displayed.

Inch specifications

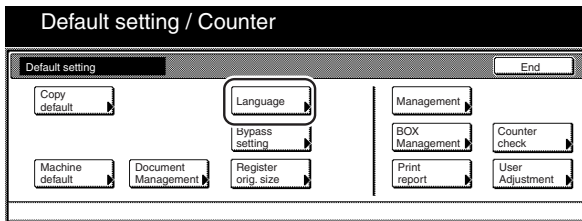

Metric specifications

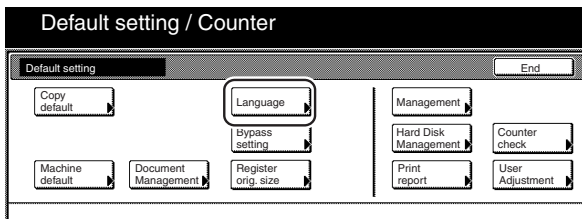

- 3 Touch the key that corresponds to the language that you want to use.

The language used on the touch panel will change to that selected.

Inch specifications

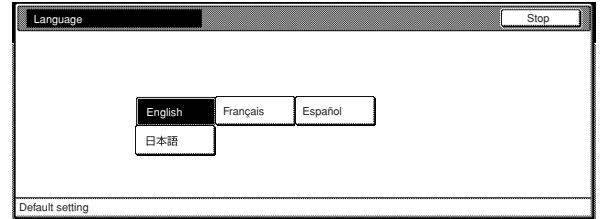

Metric specifications

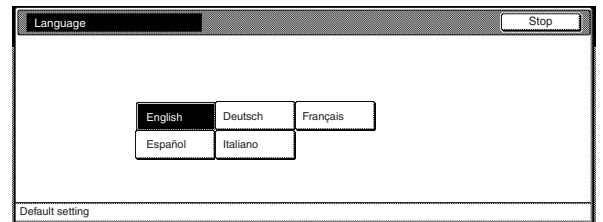

11. Entering characters

Use the following screens to enter characters when registering names for programs and for departments, etc.

(1) Character input screens

Inch specifications

Letter keyboard

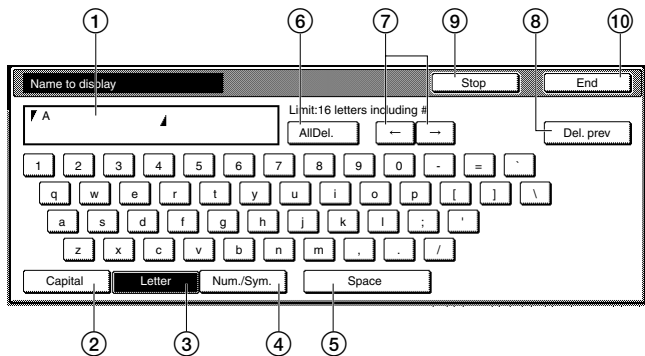

- ① Entry field
Displays entered information.
- ② “Capital” key
Touch this key when you want to enter uppercase letters.
- ③ “Letter” key
Touch this key when you want to enter lowercase letters.
- ④ “Num. /Sym.” key
Touch this key when you want to enter numerals and symbols.
- ⑤ “Space” key
Touch this key when you want to enter a space.
- ⑥ “AllDel.” key
Touch this key when you want to delete all characters that have been entered to this point.
- ⑦ “←” and “→” keys
Touch these keys when you want to move the cursor.
- ⑧ “Del. prev” key
Touch this key when you want to delete the character to the left of the cursor.
- ⑨ “Stop” key
Touch this key when you want to cancel character input and return to the previous screen.
- ⑩ “End” key
Touch this key when you want to register the entered information.

Capital keyboard

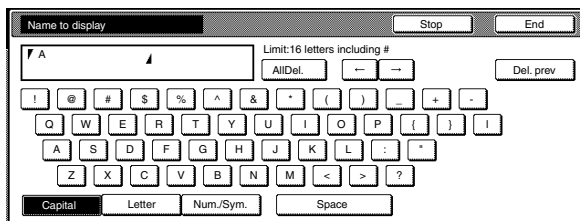

Numeral/Symbol keyboard

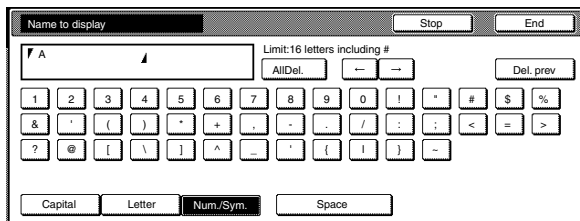

Section 7 COPIER MANAGEMENT FUNCTIONS

Metric specifications

Letter keyboard

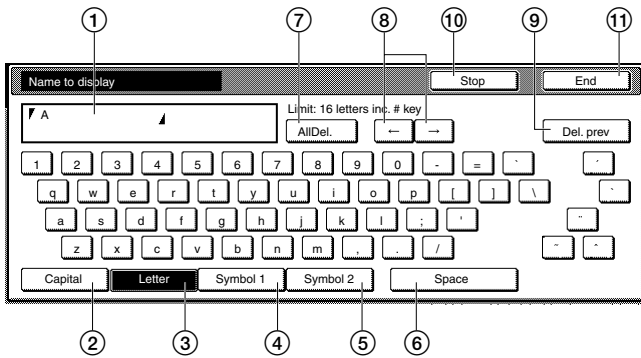

- ① Entry field
Displays entered information.
- ② "Capital" key
Touch this key when you want to enter uppercase letters.
- ③ "Letter" key
Touch this key when you want to enter lowercase letters.
- ④ "Symbol 1" key
Touch this key when you want to enter certain symbols.
- ⑤ "Symbol 2" key
Touch this key when you want to enter certain symbols.
- ⑥ "Space" key
Touch this key when you want to enter a space.
- ⑦ "AllDel." key
Touch this key when you want to delete all characters that have been entered to this point.
- ⑧ "←" and "→" keys
Touch these keys when you want to move the cursor.
- ⑨ "Del. prev" key
Touch this key when you want to delete the character to the left of the cursor.
- ⑩ "Stop" key
Touch this key when you want to cancel character input and return to the previous screen.
- ⑪ "End" key
Touch this key when you want to register the entered information.

Capital keyboard

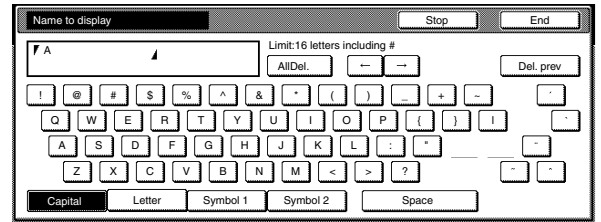

Symbol 1 keyboard

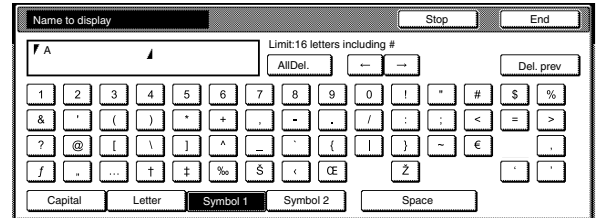

Symbol 2 keyboard

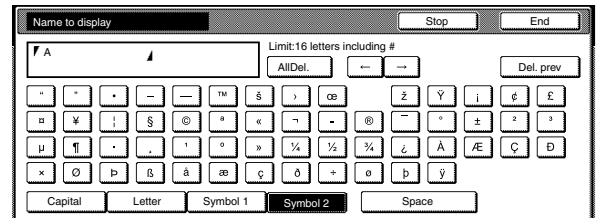

Section 7 COPIER MANAGEMENT FUNCTIONS

(2) Character input procedure

[Example] "Abcde"

- 1 Touch the "Capital" key. The "Capital" will be displayed. Touch the "A" key on the keyboard.

Inch specifications

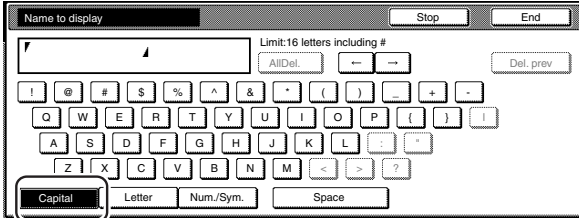

Metric specifications

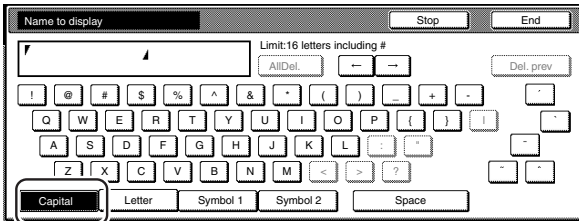

- 2 Touch the "Letter" key.

Inch specifications

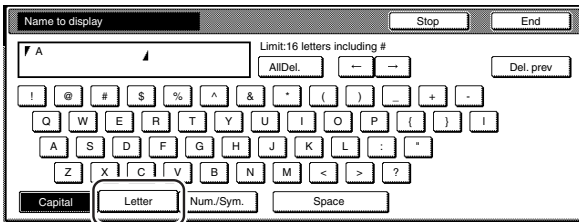

Metric specifications

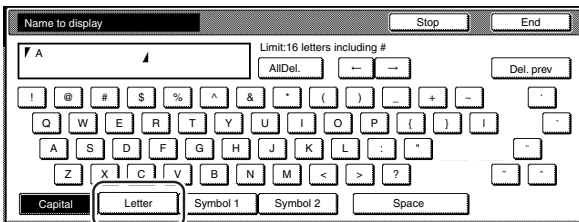

- 3 Touch the "b", "c", "d" and "e" keys, in that order, on the keyboard.

Inch specifications

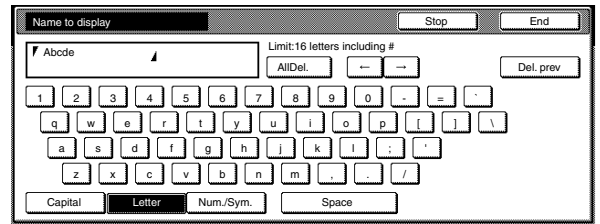

Metric specifications

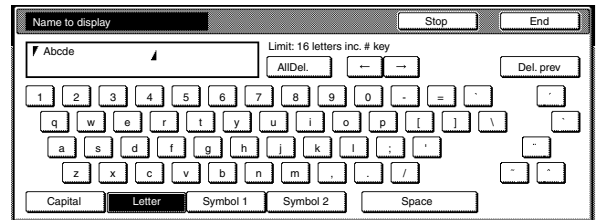

- 4 Once you have finished entering the information, touch the "End" key.

Inch specifications

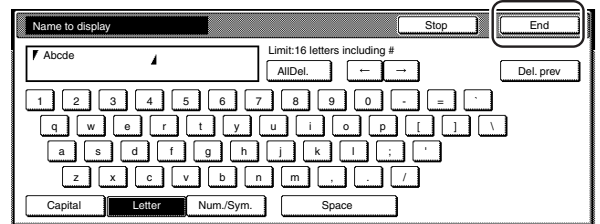

Metric specifications

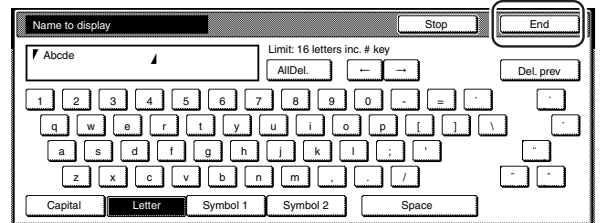

Section 8 OPTIONAL EQUIPMENT

(1) Document Processor

The Document Processor automatically feeds one-sided originals one by one for scanning. It also reverses two-sided originals automatically for duplex copying and page separation copying.

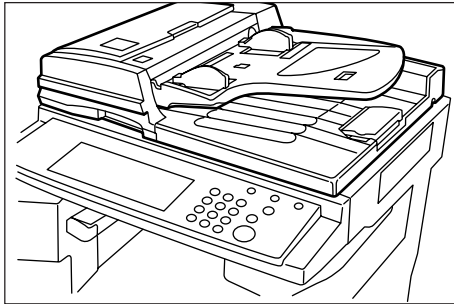

① Originals that can be used with the Document Processor

- Sheet originals only
- Original weights: Single-sided original of 35 g/m² to 160 g/m² two-sided original of 50 g/m² to 120g g/m²
- Original sizes: 11" x 17"/A3 (maximum) to 5 1/2" x 8 1/2"/A5R (minimum)
- Capacity:
 - 100 sheets (8 1/2" x 11"/A4 and smaller, 75 g/m² or 80 g/m²)
 - 70 sheets (8 1/2" x 14"/Folio and larger, 75 g/m² or 80 g/m²)
 - 30 sheets in auto selection mode

② Precautions for the use of Document Processor

Do not use any of the originals given below with the Document Processor. Also do not set originals with punch holes or tear-off strips positioned at the leading edge.

- Transparency films
- Carbon paper and extremely creased or folded originals, originals of sort material such as vinyl
- Non-square originals, wet originals, originals with adhesive tape or glue
- Originals bundled with a paper clip or staple (if inevitable, remove the paper clip or staple and straighten out the creases and folds before setting the originals)
- Clipped out originals, originals with slippery surface
- Originals with still-wet whiteout
- Originals with creases (if inevitable, straighten out the creases before setting the originals)

③ Document Processor part names

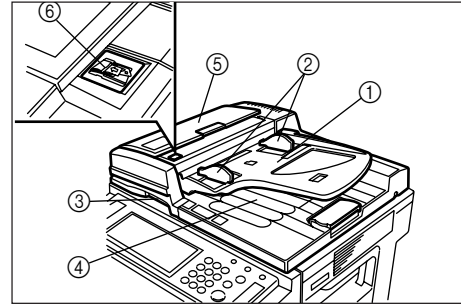

- ① Original table
(Place the originals here.)
- ② Original insertion guides
(Adjust the guides to the width of the originals.)
- ③ Document Processor open/close handle
(Hold this handle when opening and closing the Document Processor.)
- ④ Original eject cover
(Copied originals are stored here.)
- ⑤ Document Processor original cover
(Open this cover to remove an original misfed in the Document Processor.)
- ⑥ Original set indicator
(Lights green when the originals are set.)

Section 8 OPTIONAL EQUIPMENT

④ How to set originals in the Document Processor

- 1 Adjust the original insertion guides to the original size.

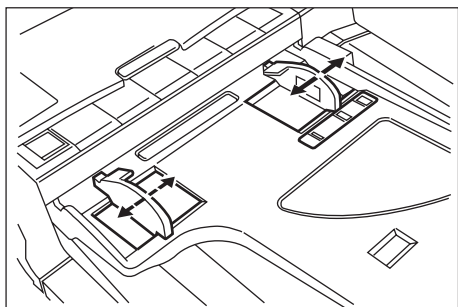

NOTE

Before setting the originals in the Document Processor, check that no original from the previous operation is remaining on the original eject cover. Originals remaining on the original eject cover may cause original misfeed.

- 2 Set the originals on the original table in correct sequence with the side to be copied facing upward. Securely insert the leading edge of the originals into the Document Processor as far as they will go.

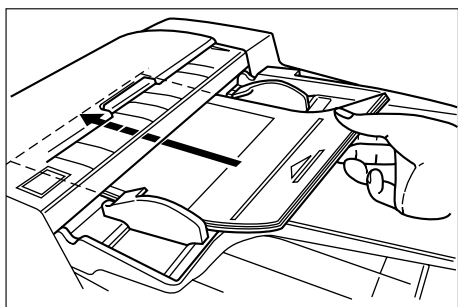

* When setting large size paper such as 8 1/2" x 11", A4R or larger, pull out the support extension.

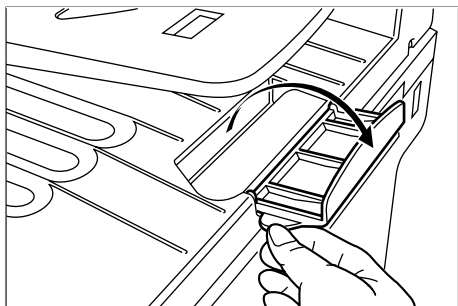

IMPORTANT!

Do not set originals exceeding the limit indicated on the sticker attached on the rear original insertion guide. Setting more originals than specified may cause original misfeed.

⑤ How to set originals on the platen

When using an original that cannot be set in the Document Processor, such as a book or magazine, open the Document Processor and place it on the platen.

- 1 Hold the Document Processor open/close handle and open the Document Processor.
 - * Before opening the Document Processor, check that no original is present on the original table or original eject cover. If present, the original may fall off when the Document Processor is opened.

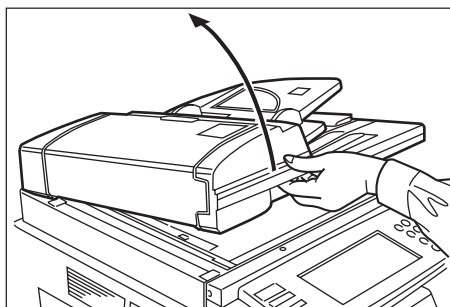

- 2 Set the original with the side to be copied facing downward. Be sure to align the original with the original size scales.

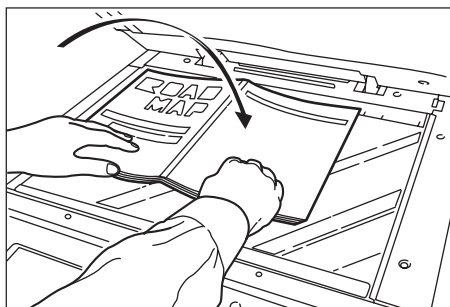

- 3 Hold the Document Processor open/close handle and close the Document Processor.

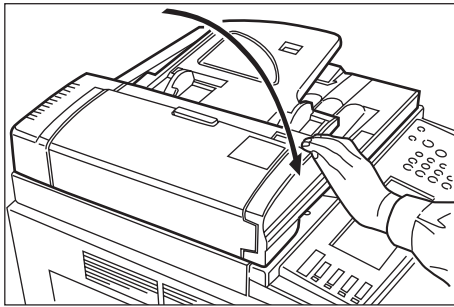

IMPORTANT!

Do not press the Document Processor against the platen with force. Doing so may cause damage to the glass material.



CAUTION

DO NOT leave the Document Processor open as there is a danger of personal injury.

⑥ Auto selection/Filing mode

With this mode, when you are using the Document Processor without pressing one of the paper size keys, and thereby, specifying a desired paper size, originals will be checked one by one for their size, and you can select to either have paper of the same size as each original selected automatically (auto selection) or to have the originals all copied onto one single size of copy paper (filing).

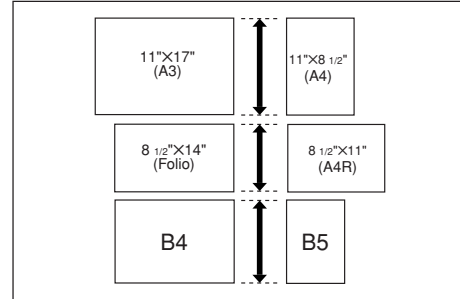

IMPORTANT!

- You can set up to 30 originals in the Document Processor in this mode.
- Inch specifications
- Only 11" x 8 1/2" and 11" x 17", or 8 1/2" x 14" and 8 1/2" x 11", size originals can be used together in this mode, and the originals must be arranged together so that their widths coincide.
- Metric specifications
- Only A4 and A3, B5 and B4, or A4R and Folio, size originals can be used together in this mode, and the originals must be arranged together so that their widths coincide.
- Metric specifications (Asia Pacific)
- Only A4 and A3, B5 and B4, size originals can be used together in this mode, and the originals must be arranged together so that their widths coincide.

● **Differing finished sizes (Auto selection)**

Each original will be copied onto the same size copy paper as that original.

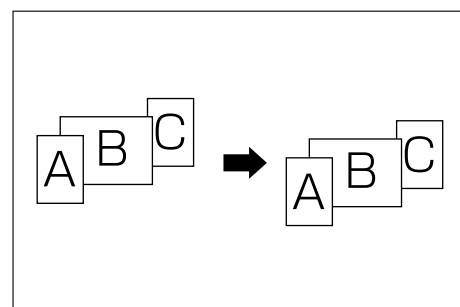

Section 8 OPTIONAL EQUIPMENT

● Matching finished sizes (Filing)

All originals will be copied onto the same size copy paper.

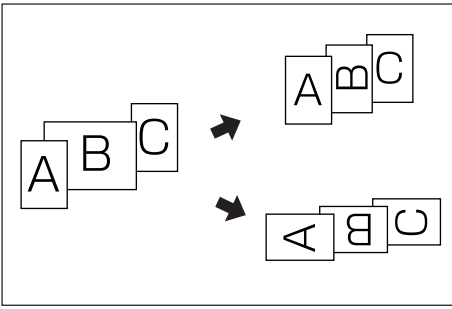

1 Set the originals to be copied in the Document Processor.

2 Press the [Auto Selection] key. The lamp in the [Auto Selection] key will light and the auto selection/filing mode screen will be displayed.

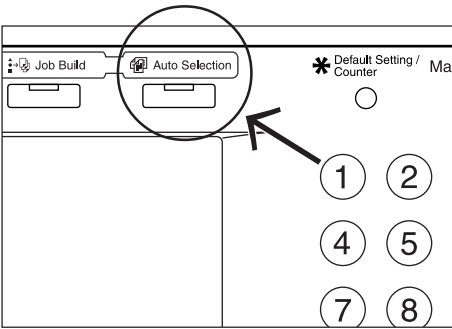

3 Touch the "Auto selection" key or the "Electronic Filing" key, as appropriate.

If you selected "Auto selection", go directly to step 6.

If you selected "Electronic Filing", go to the next step.

Inch specifications

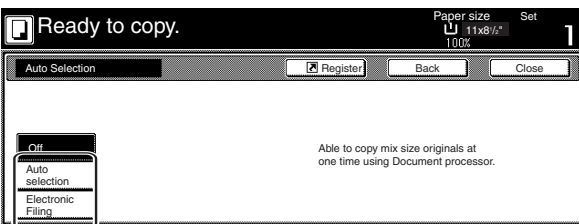

Metric specifications

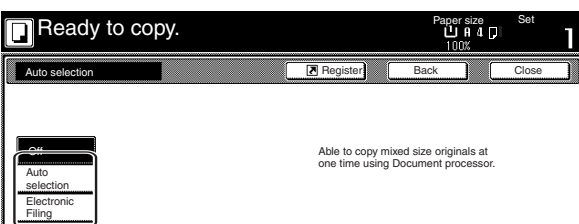

4 Specify the size of the very first original to be copied and then touch the "Close" key. The touch panel will return to the contents of the "Basic" tab.

Inch specifications

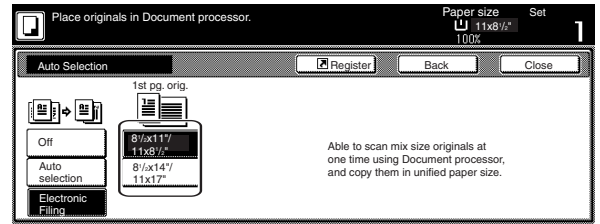

Metric specifications

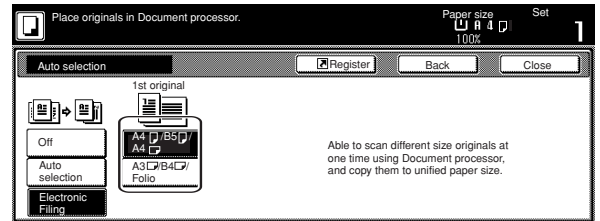

NOTE

In order to have the binding direction set properly for stapling or hole punching, etc., finished copies, be sure to specify the size of the very first original being copied.

5 Select the desired drawer[cassette].

Inch specifications

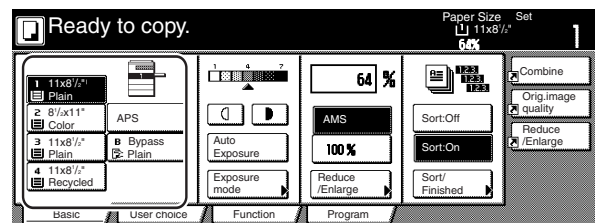

Metric specifications

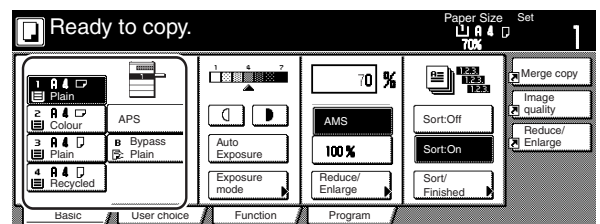

6 Press the [Start] key. Copying will start.

(2) Paper Feeder

Two Paper Feeders of the same type as drawer[cassette] in the main body can be added.

Capacity and the paper loading method is the same as those for the standard drawer[cassette] in the main unit.

* Paper misfed in the optional Paper Feeder can be removed by opening its left cover.

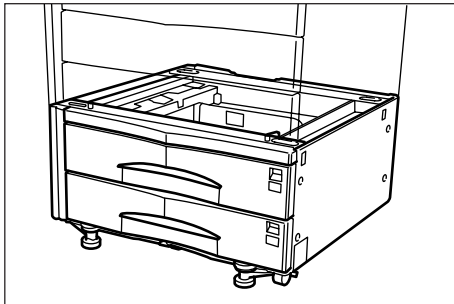

(3) Paper Feeder

The Paper Feeder holds up to 3,000 sheets of 11" x 8 1/2" [A4 or B5 (B5 is for Asia-Pacific specification copiers only)] size standard paper. Pull the Paper Feeder out towards you as far as it will go, and then load up to 1,500 sheets of paper in each rows.

* The cover on the left side of the Paper Feeder is prepared to remove misfed paper.

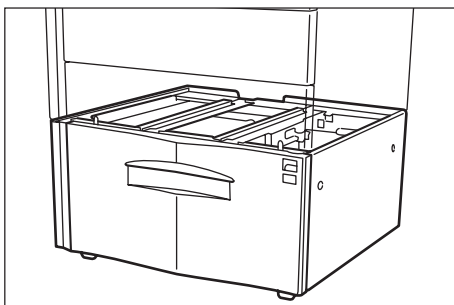

(4) Document Finisher

This unit lets you store a large volume of copies and shifts the position of each copy set for ease of sorting. It can staple finished copy sets and bind them. It is also possible to use the Document Finisher to punch holes in them for filling purposes (optional). For more detailed information, refer to the Operation Guide for the Document Finisher.

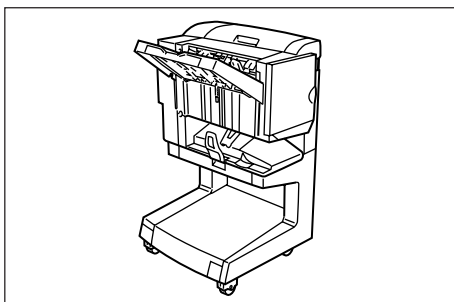

IMPORTANT!

- If copies come out curled or are tacked unevenly, turn the paper in the drawer[cassette] over.
- When copying onto special paper such as OHP film and other transparencies, use Non-sort mode.

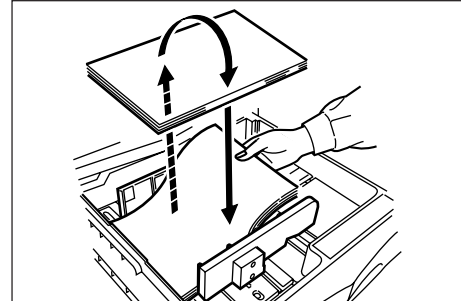

① Copying in the Sort:ON mode

This mode automatically sorts copies made from multiple originals into sets identical to the originals.

- 1 Touch the "Sort/Finished" key. The "Sort/Finished" screen will appear.

Inch specifications

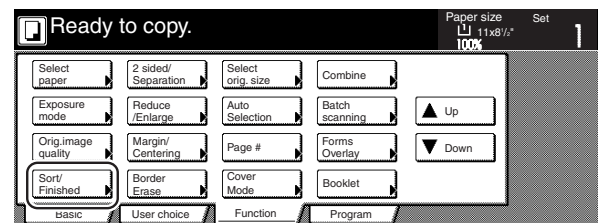

Metric specifications

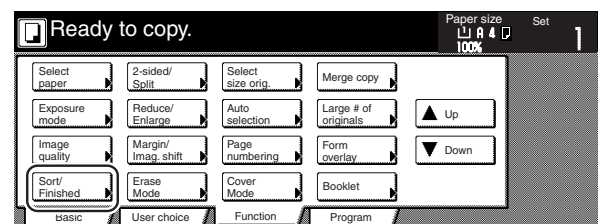

Section 8 OPTIONAL EQUIPMENT

- Touch the "Sort:On" key.
(Only for metric specification copiers produced)
The "Output each page" key will be changed to the "1 set" key.

Inch specifications

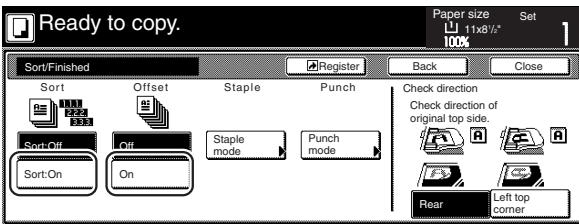

Metric specifications

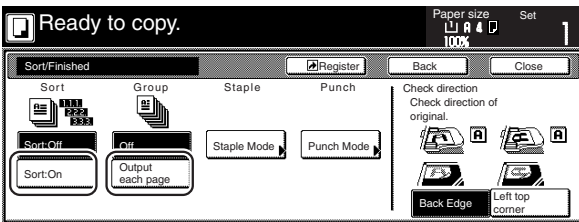

- Touch the "On" ["1 set"] key.
- Touch the "Close" key. The message display returns to the Function screen.
- Set the originals to be copied.
- Press the [Start] key. Scanning of the originals will start. The number of scanned originals will be displayed.

NOTE

Repeat this operation for all originals when using the platen. After all the originals have been scanned, touch the "Scanning finished" key.

- Copying will begin and finished copies will be ejected face down onto the tray with each full set shifted slightly from the previous one.
- Remove all of the finished copies from the tray.

② Copying in the Sort:OFF mode

This mode automatically groups copies made from multiple originals, with all the copies produced from an individual original stacked together in one set.

- Touch the "Sort/Finished" key.
The "Sort/Finished" screen will appear.

Inch specifications

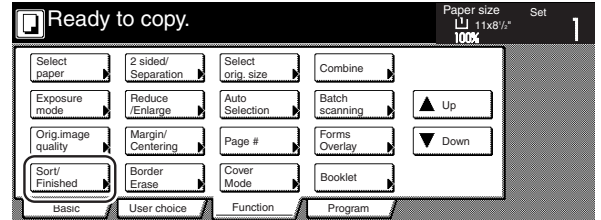

Metric specifications

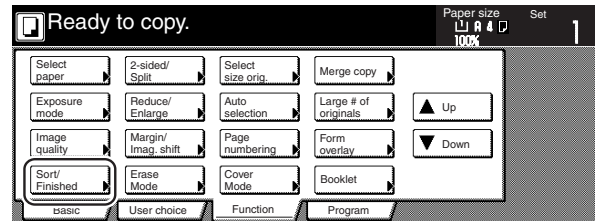

- Touch the "Sort:Off" key.

Inch specifications

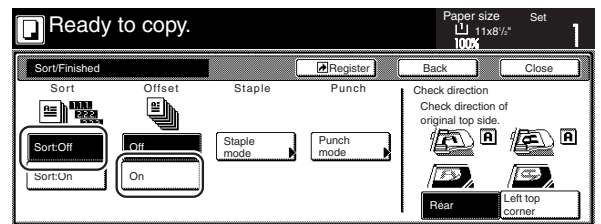

Metric specifications

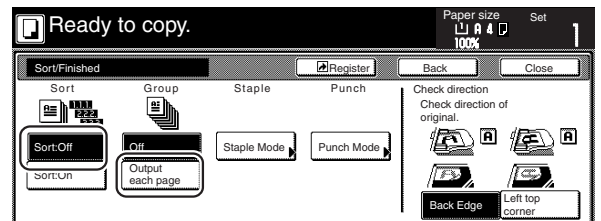

- Touch the "On" ["Output each page"] key.
- Touch the "Close" key. The message display returns to the Function screen.
- Set the originals to be copied.
- Press the [Start] key. Scanning of the originals will start. The number of scanned originals will be displayed.

NOTE

Repeat this operation for all originals when using the platen. After all the originals have been scanned, press the “Scanning finished” key.

7 Copying will begin and finished copies will be ejected face down onto the tray with each full set shifted slightly from the previous one.

8 Remove all of the finished copies from the tray.

③ Copying in the Staple mode

This mode automatically staples each copy set.

1 Touch the “Sort/Finished” key. The “Sort/Finished” screen will appear.

Inch specifications

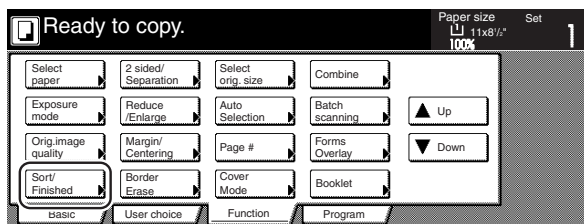

Metric specifications

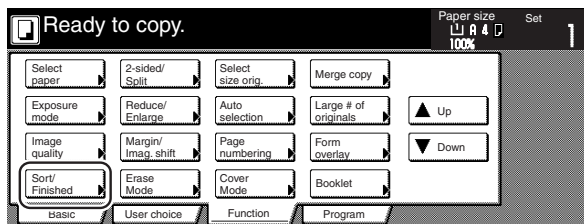

2 Touch the “Staple mode” key. The staple mode set-up screen will appear.

Inch specifications

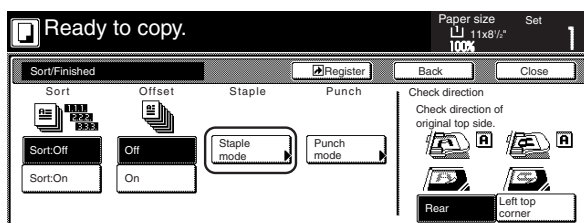

Metric specifications

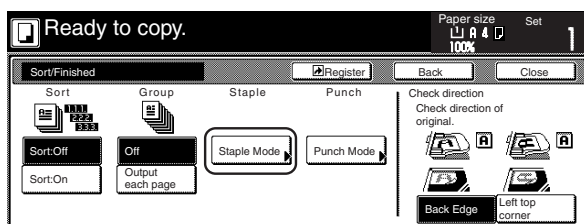

3 Touch the key that corresponds to the desired stapling style.

Inch specifications

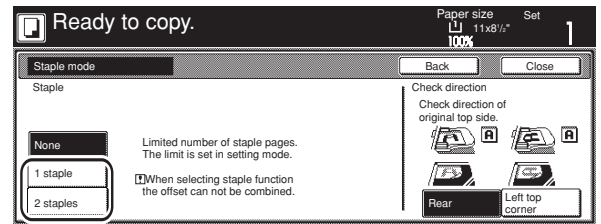

Metric specifications

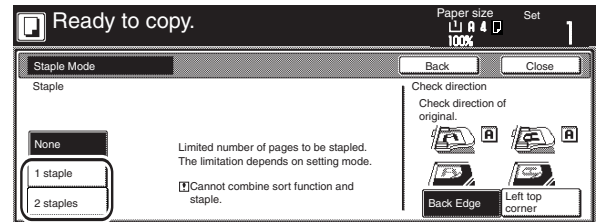

* Stapling will be accomplished as shown in the illustration (as viewed from the front of the copies).

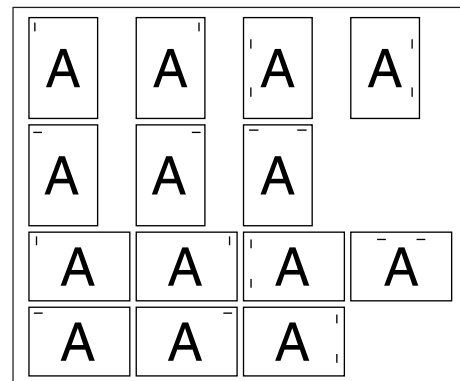

4 Set the originals to be copied. Check the direction of the original top side.

5 Press the [Start] key. Scanning of the originals will start. The number of scanned originals will be displayed.

NOTE

Repeat this operation for all originals when using the platen. After all the originals have been scanned, touch the “Scanning finished” key.

6 Copying will begin and the copies will be automatically stapled and ejected face down onto the tray.

7 Remove all of the finished copies from the tray.

Section 8 OPTIONAL EQUIPMENT

④ Copying in the Hole Punch mode (optional)

Copies can be automatically hole punched.

- 1 Touch the "Sort/Finished" key.
The "Sort/Finished" screen will appear.

Inch specifications

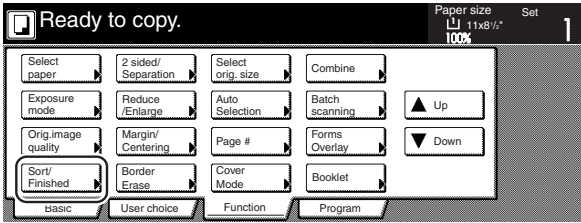

Metric specifications

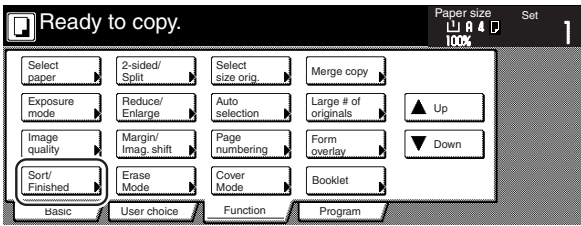

- 2 Touch the "Punch mode" key.
The hole "Punch" screen will appear.

Inch specifications

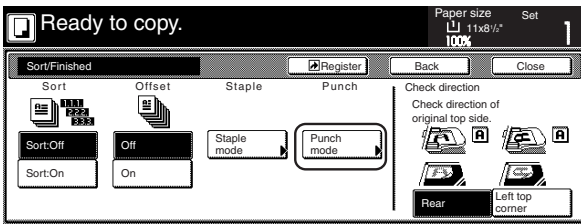

Metric specifications

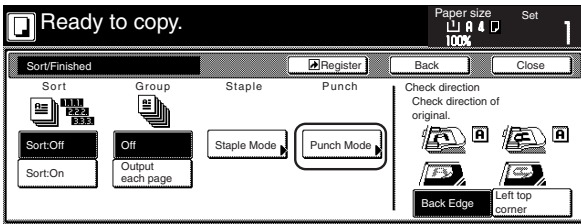

- 3 <Inch specification copiers>
Touch the "2 holes" key or the "3 holes" key, as appropriate.
The screen to select the hole positioning will appear.
<Metric specification copiers>
Touch the "4 holes" key. The screen to select the hole positioning will appear.

* If your copier has been set for 2-hole punching, you can have the "4 holes" key changed in order to display it as a "2 holes" key.

Inch specifications

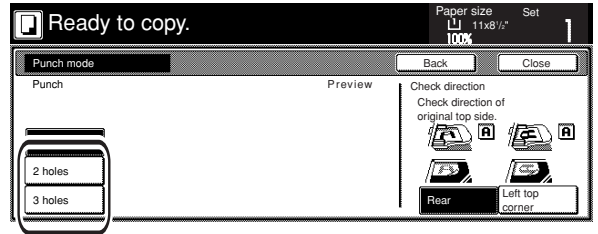

Metric specifications

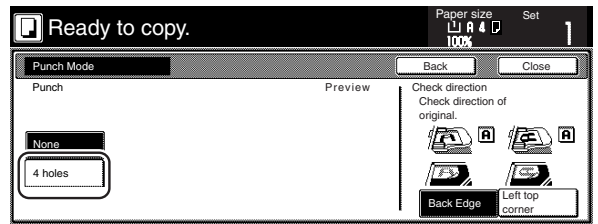

- 4 Touch the key that corresponds to the desired position of holes.
Inch specifications

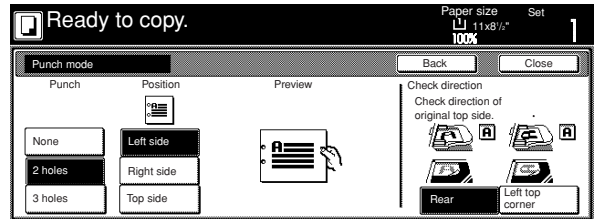

Metric specifications

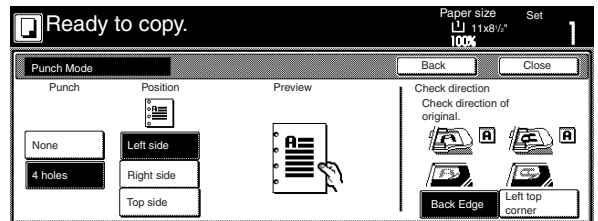

* Hole punching will be accomplished as shown in the illustration (as viewed from the front of the copies).

Inch specifications

Metric specifications

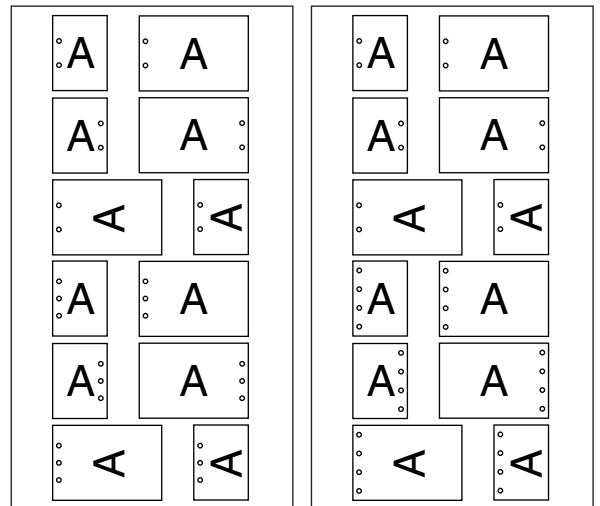

IMPORTANT!

When the optional punch unit is not installed, the "Punch mode" key will not appear.

IMPORTANT!

The position of the holes on each page may differ very slightly due to the fact that holes are punched in one sheet at a time.

- 5** Set the originals to be copied.
- 6** Press the [Start] key. Scanning of the originals will start. The number of scanned originals will be displayed.

NOTE

Repeat this operation for all originals when using the platen. After all the originals have been scanned, touch the "Scanning finished" key.

- 7** Copying will begin and the copies will be automatically punched and ejected face down onto the tray.
- 8** Remove all of the finished copies from the tray.

(5) Document Finisher

The Document Finisher stores a large quantity copies, and sorts multiple sets by shifting the position that each one is ejected. It is also possible to use the Document Finisher to staple the copy sets or punch holes in them for filling purposes. For detailed information on the sort mode, refer to the Operation Guide for the Document Finisher. For more information on the corresponding procedures, refer to "(4) Document Finisher" on page 8-5 of this guide.

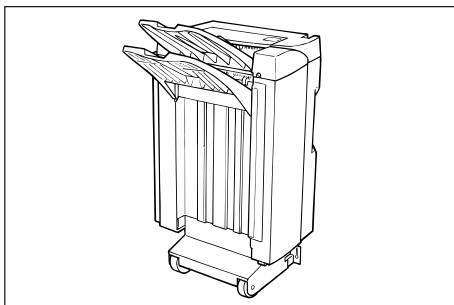

*** Stacking mode**

If the number of copies to be made in the Non-sort mode is set to a number greater than the acceptable limit (250 sheets), the finished copies will be ejected onto the Sort tray.

(6) Document Finisher

The Document Finisher stores a large quantity copies, and sorts multiple sets (Sort: ON) or groups copies made from multiple originals, with all the copies produced from an individual original grouped together in one set (Sort: OFF). It is also possible to use the Document Finisher to staple sorted copy sets. For detailed information on the sort mode, refer to the Operation Guide for the Document Finisher. For more information on the corresponding procedures, refer to "(4) Document Finisher" on page 8-5 of this guide.

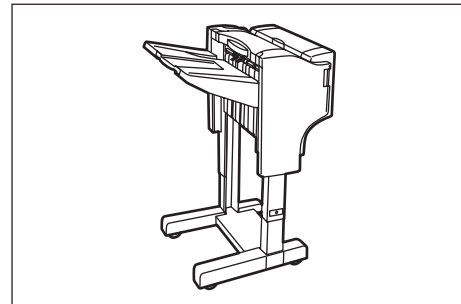

* Stapling will be accomplished as shown in the illustration (at the top and from the front of the copies).

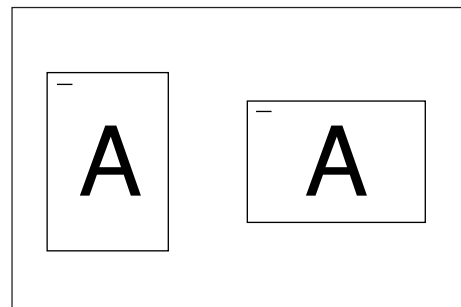

(7) Built-in Finisher

The finisher stores a large quantity of copies. It can also sorts multiple copies into sets by shifting the eject position. Paginated copies can be stapled, too.

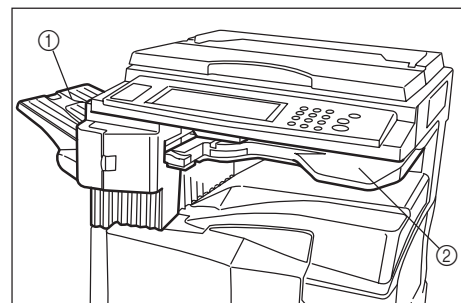

- ① Sort tray
- ② Finisher tray

Section 8 OPTIONAL EQUIPMENT

* Sorted copies are ejected to the Sort tray.

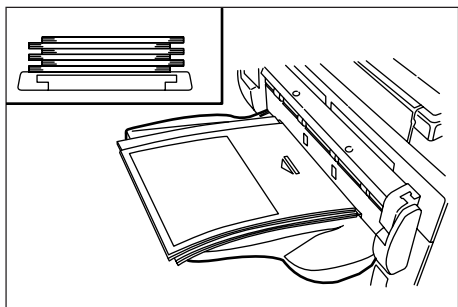

* When setting large size paper such as 8 1/2" x 11", A4R or larger, pull out the support extension.

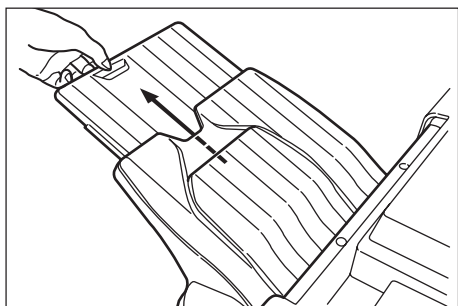

① Refilling the Stapling Unit

1 Open the stapler front cover towards you.

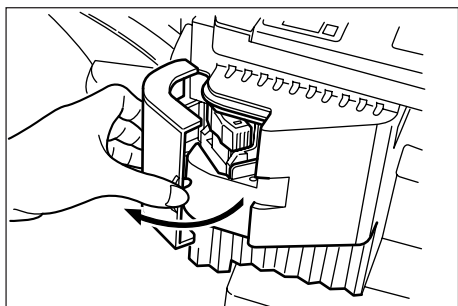

2 Pull out the staple holder.

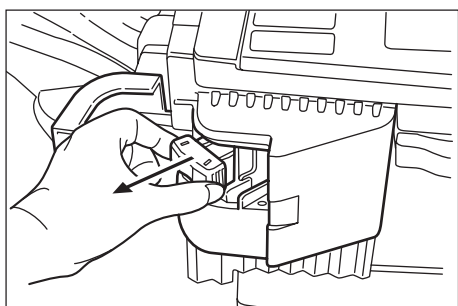

3 Remove the empty staple cartridge from the staple holder.

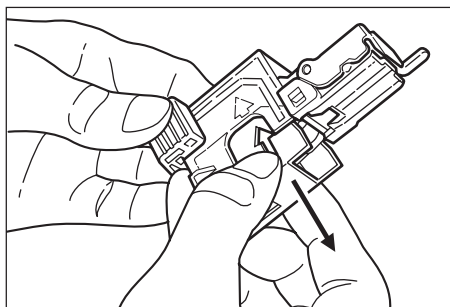

4 Hold the staple holder in one hand and the new staple cartridge in the other and insert the new staple cartridge making sure the direction of insertion is correct.

* The arrow on the staple cartridge indicates the correct direction of insertion.

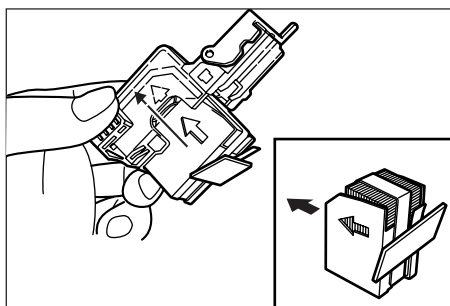

5 Make sure the new staple cartridge is completely inserted all the way into the staple holder and then remove the paper tape covering the staple cartridge.

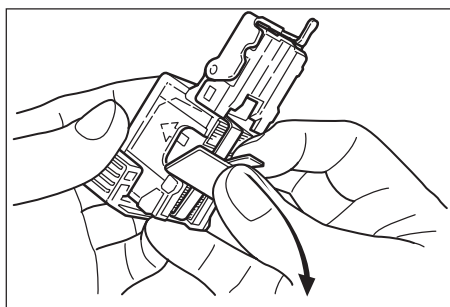

6 Replace the staple holder back in its original position in the Stapling Unit. Once it has been fully inserted, it will click into place.

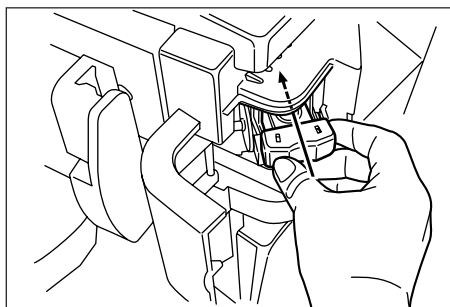

② Clearing a staple jam

- 1 Remove the staple cartridge referring to the “① Refilling the Stapling Unit”. Push up on the tab “A” on the protective faceplate in order to raise the faceplate.

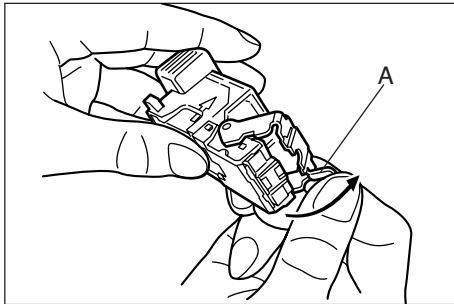

- 2 Remove the jammed staple from the tip of the staple cartridge (the end where staples are set).

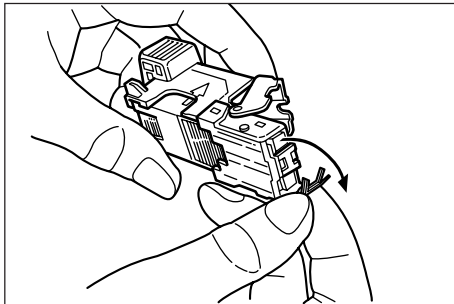

- 3 Lower the protective faceplate back into its original position.

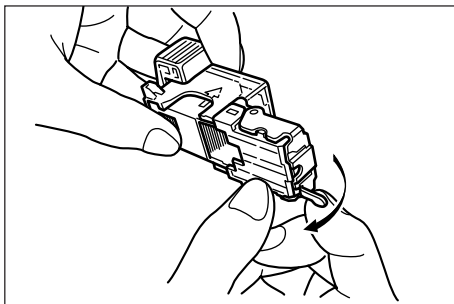

- 4 Replace the staple holder back in its original position in the Stapling Unit. Once it has been fully inserted, it will click into place.

- 5 Lift up the Stapling Unit slightly and then lower it into its original position.

- 6 Close the stapler front cover securely.

(8) Job Separator

When using the optional printer function, the paper eject point can be changed according to the used function, making it easier to sort paper.

Copied paper can be ejected to the Job Separator (upper section). See “Copy eject location” in Machine default setting on page 7-49.

* The Job Separator can store up to 100 copies. When making 101 or more copies, copying will stop when 100 copies are made. Copying will resume automatically when the copied sheets are removed.

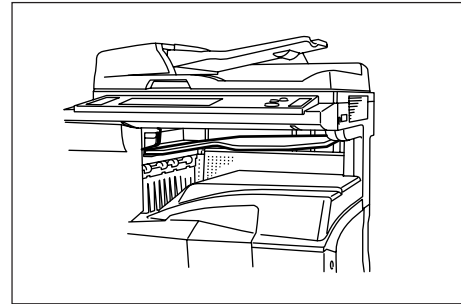

(9) Hard Disk

The Hard Disk is required in order to use the following modes and functions of your copier.

- Job reservation during copying
- Form overlay of registered forms
- Repeat copying
- Document management functions
- Using the output management functions to change the job printing order, cancel and delete print jobs, and verify content

It is also possible to register up to 1000 department ID-codes under document management.

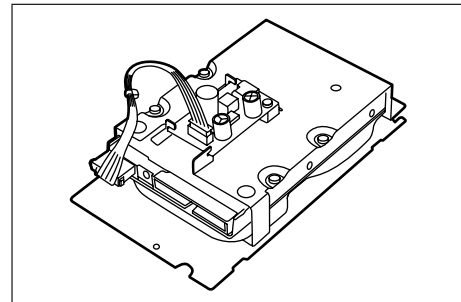

(10) Key Counter

The Key Counter determines the number of copies that have been made. It is useful for copier centralized management on a department or even company level.

* The Key Counter may count up when either data from a computer is printed out or fax pages are printed out.

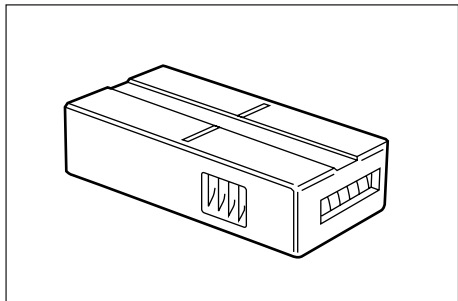

• Setting the Key Counter

Insert the Key Counter securely into the Key Counter opening.

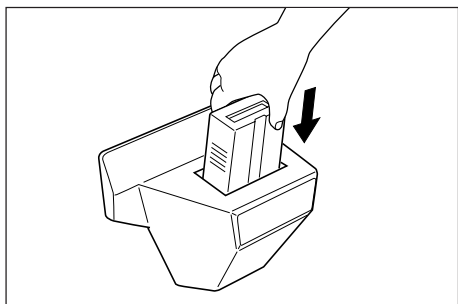

NOTE

When the Key Counter function is used, copies cannot be made unless the Key Counter is inserted into the copier. If the Key Counter is not inserted securely, "Insert key counter." appears on the message display.

(11) Document Tray

The Document Tray lets you place originals and other documents next to the machine before using them, etc. It also contains space for storing paper clips, etc.

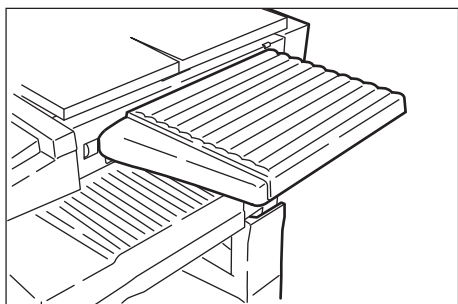

(12) Printer Kit

If the Printer Kit is installed, this copier can be used as a printer. For more detailed information, see the printer's Operation Guide. Since the network board is equipped, this copier can also be used as a network printer, allowing access from multiple computers. The optional printer network kit and hard disk are also available.

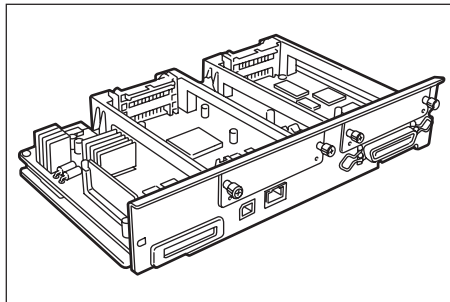

(13) Printer/Scanner Kit

If the Printer/Scanner Kit is installed, this copier can be used as a printer or a network scanner. For more detailed information, see the Operation Guide for the Printer/Scanner Kit. Since the network board is equipped, this copier can also be used as a network printer, allowing access from multiple computers. The optional printer network kit and hard disk are also available.

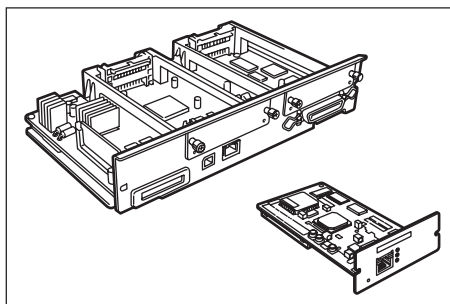

(14) Fax Kit

If the Fax Kit is installed, this copier can be used as a fax. Also if the Fax Kit is used together with the optional Printer/Scanner Kit, this copier can be used as a network fax, allowing transmission and reception by a computer. For details, see the Operation Guide for the fax.

* In some cases, this function may not be used.

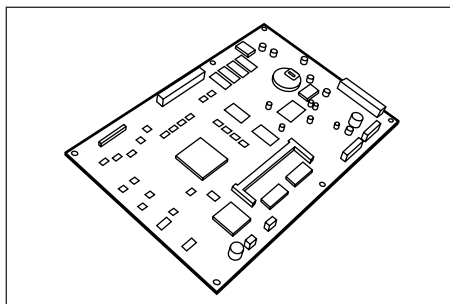

Section 9 TROUBLESHOOTING

1. If one of the following messages is displayed

When any of the following messages appears on the message display, take the indicated action.

| Message | Procedure | Reference page |
|---|---|----------------|
| "Close xxx cover x." | The cover indicated is open. Close the cover securely. | — |
| "Add paper in drawer." ["Add paper in cassette."] | There is no paper in the drawer[cassette] indicated. Load paper. | 3-1 |
| "Set drawer." ["Close paper cassette."] | One of the drawers[cassettes] is not closed properly. Pull it out and push it back in all the way. | — |
| "Paper drawer is out of order. Select another paper drawer." ["Paper cassette is out of order. Select other paper cassette. "] | The drawer[cassette] currently in use is out of order and cannot be used. Contact your service representative immediately. Continue copying using another drawer[cassette]. | — |
| "Check paper size." | No paper that can be used in the selected mode is loaded. Check the paper. | — |
| "Reposition original." | The orientation of the original and the selected paper are different. Change the orientation of the original. If the [Start] key is pressed, same-size copying will be performed. | — |
| "Exceeds pre registered copying quantity." ["Copy limit for this ID-code has been reached. No copying possible. "] | The number of copies reached the limit set in the copy management mode and no more copies can be made. Clear the copy count from the management mode. | 7-1 |
| "Ready to copy. Add toner." | There is not enough toner in the copier. Replace the toner container immediately as only one copy can be made at a time. | 10-3 |
| "Add toner to resume copying." | There is not enough toner in the copier to make copies. Replace the toner container immediately. | 10-3 |
| "System error. Main switch off/on." | A system error has occurred. Turn the power switch OFF and then ON. | — |
| "System error. Disconnect power plug from the socket." | A system error has occurred. Disconnect the power plug from the outlet and connect it again. | — |

* If the optional Fax Kit is installed in your copier, when the power cord is unplugged from the outlet, original data or reserved communication information stored in the memory may be lost.

Section 9 TROUBLESHOOTING

| Message | Procedure | Reference page |
|--|--|----------------|
| "Call service." | Open and close the front cover. If the same message appears again, make a note of the "C" and the number appearing with it, turn the power switch OFF (O), unplug the power cord from the outlet, and contact your service representative or authorized service center. | — |
| "Time for maintenance." | Periodic maintenance is necessary to keep your copier in good condition. Contact your service representative or an authorized service center as soon as possible. | — |
| "Close Document processor cover." | The Document Processor original cover of the optional document processor is open. Close the cover securely. | — |
| "Memory full." | <p>The copier memory is full. Either print out or clear all scanned data. It is not possible to copy or scan another original until one of these two operations is performed. The copier memory size and the capacity for scanning originals are shown below.</p> <p>Number of originals that can be scanned*</p> <p>Standard memory (64MB): approximately 322 pages</p> <p>When the optional Hard Disk is installed (20GB): approximately 70,000 pages**</p> <p>* When using our standard original (A4 original, 6% text)</p> <p>** The maximum number of originals that can be scanned at one time is 999 (11" x 8 1/2" [A4]).</p> | — |
| <p>"Paper misfeed."</p> <p>"Paper misfeed. Careful for Drum."</p> | If paper is misfed, the copier will stop and the location of the misfeed will appear on the message display. Remove the misfed paper with the power switch turned ON () by following the appropriate procedure. If "Careful for Drum." is displayed, be sure not to touch the drum area that is located inside the machine when removing the jammed paper. | 9-4 |
| <p>"Duplex tray inoperable, call service."</p> <p>["Duplex unit is out of order. Call service."]</p> | The duplex unit is out of order and duplex copying is not possible. Contact your service representative immediately. | — |
| "Clean the slit glass for original fed from DP." ["Clean the slit glass for original fed."] | The slit glass is dirty. This may result in black lines or other blemishes appearing on copies when you use the optional Document Processor, so you should perform the cleaning operation on the slit glass. | 10-1 |
| "Attach Finisher." | Connect the optional Document Finisher securely to the copier. | — |
| "Finisher is out of order. Detach Finisher." | The optional Document Finisher is out of order and cannot be used for the moment. Contact your service representative or an authorized service center as soon as possible. | — |
| "Paper capacity exceeded. Remove paper from Finisher." | The maximum number of sheets that can be stored on the optional Document Finisher has been exceeded. Remove the copies from the Document Finisher. | — |
| "Remove paper form inner tray of Finisher." | Paper has been misfed inside the optional Document Finisher. See the Document Finisher's Operation Guide and remove the paper. | — |

| Message | Procedure | Reference page |
|---|--|----------------|
| “Out of staples. Add staples.” [“Stapler empty. Add staples.”] | There are no staples in the optional Document Finisher. See the Document Finisher’s Operation Guide and replace the staple cartridge. | — |
| “Cannot staple this size.” [“Cannot staple this paper size.”] | Stapling is not possible with small size paper. For details, see the optional Document Finisher’s Operation Guide. | — |
| “Empty waste punch box.” | The hole punch chad container in the optional Document Finisher is full. Refer to the Operation Guide for your Document Finisher and dispose of the waste hole punch chads. | — |
| “Check the waste punch box.” [“Check Punch Hole box.”] | The hole punch chad container in the optional Document Finisher is not set properly. Refer to the Operation Guide for your Document Finisher and set the hole punch chad container properly. | — |
| “Replace the waste toner box.” | The waste toner box is filled with waste toner. Replace the waste toner box with a new one. | 10-3 |

2. If one of these indicators lights or flashes

If one of the indicators to the left of the [Copier] key, the [Printer] key, or the [Scanner] key either lights orange or flashes orange, carry out the appropriate procedure indicated below.

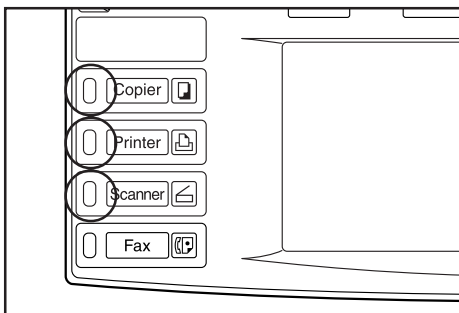

| Indication | Procedure | Reference page |
|---------------------------------|---|----------------|
| Lights orange or flashes orange | Check the appropriate response to the message, and perform the corresponding procedure. | — |

3. When paper misfeeds

If a paper misfeed occurs, a message will be displayed in the touch panel about the misfeed and copying will stop. Leave the power switch ON (|) and refer to “(2) Removal procedures” to remove the jammed paper.

Inch specification

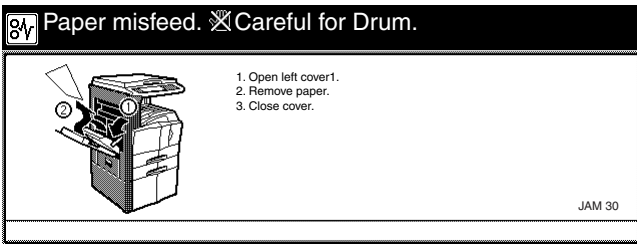

Metric specification

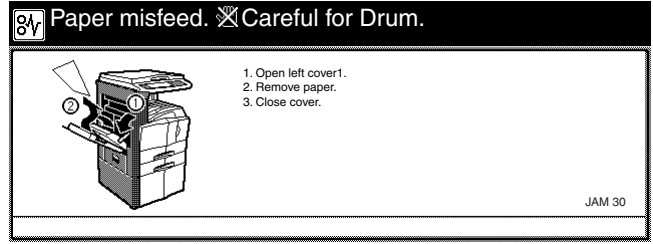

(1) Cautions

! WARNING

High voltage is present in the charger section. Take sufficient care when working in this area, as there is a danger of electrical shock.

! CAUTION

The copier's fixing unit is extremely hot. Take sufficient care when working in this area, as there is a danger of getting burned.

- Do not reuse misfed paper.
- If paper is torn during removal, be sure to remove all loose scraps from inside the copier, or they could cause misfeed later.
- After misfed paper has been removed, warm-up will begin. The Misfeed indicator will turn off and the copier will return to the same settings prior to the misfeed.

(2) Removal procedures

① Misfeed in paper feed section

- Misfeed in drawer[cassette] (JAM 10 to 13, 15 to 17)

If the message below appears, a misfeed has occurred in the drawer[cassette] (or optional Paper Feeder). Remove the misfed paper using the procedure given below.

Inch specifications

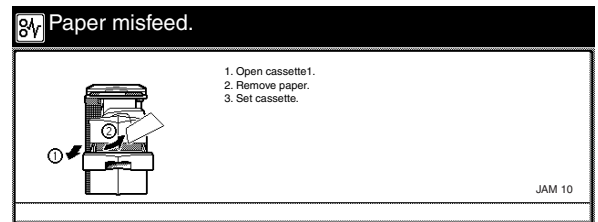

Metric specifications

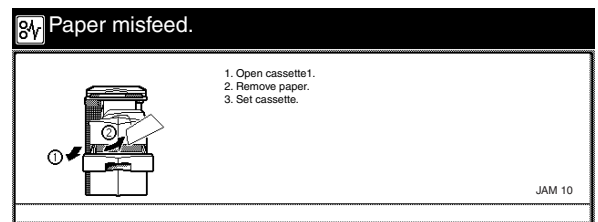

1 Open the drawer[cassette].

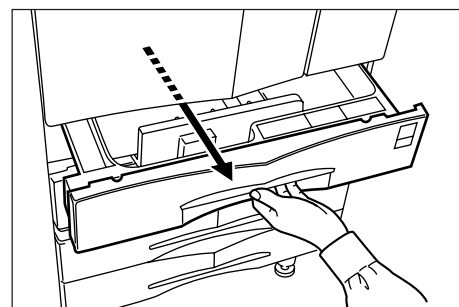

- 2** Remove the misfed paper while taking care not to tear it.
 * If the paper should be torn, remove all the scraps from the inside the copier.

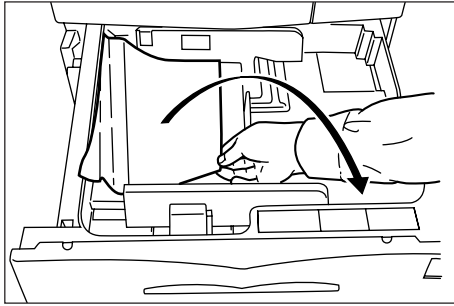

- 3** Close the drawer[cassette] slowly.

- Misfeed in left cover 1 (JAM 30, 40 to 44, 46, 47, 50 to 53, 60, 61)

If the message below appears, a misfeed has occurred in the left cover 1. Remove the misfed paper using the procedure given below.

Inch specifications

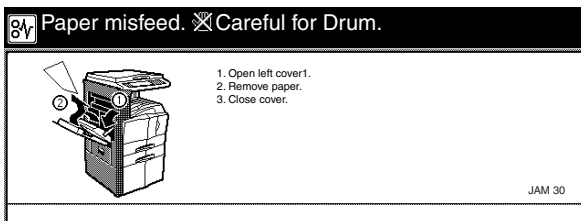

Metric specifications

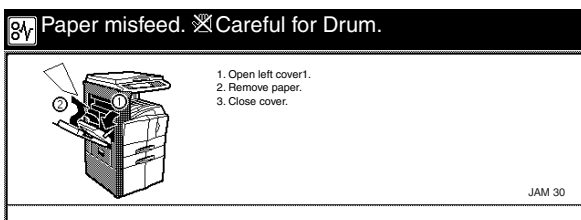

NOTE

The drum area inside the copier is extremely sensitive to dirt and damage. When removing the jammed paper, be sure not to touch the drum area that is located inside the machine with your hands, or with jewelry such as watches and rings, etc.

- 1** Pull up the left cover 1 handle to open the left cover 1.

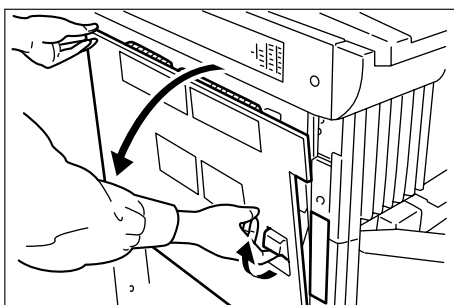

- 2** Remove the misfed paper.

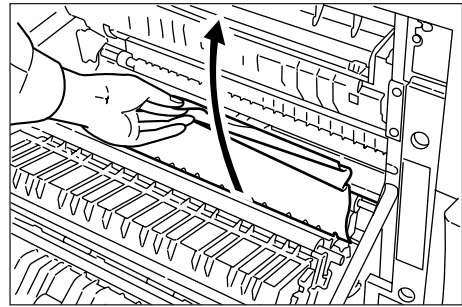

- 3** Raise the duplex unit to remove the misfed paper.

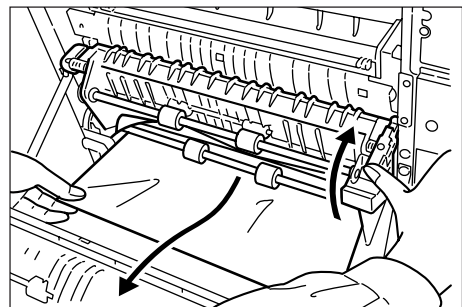

- 4** Remove the misfed paper in the output section.

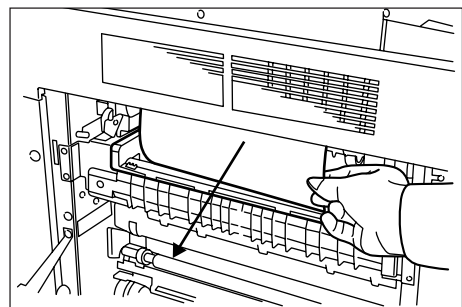

! CAUTION

The copier's fixing unit is extremely hot. Take sufficient care when working in this area, as there is a danger of getting burned.

- 5** Close the left cover 1.

Section 9 TROUBLESHOOTING

• Misfeed in left cover 1 (JAM 05)

If the message below appears, a misfeed has occurred in the left cover 1. Remove the misfed paper using the procedure given below.

Inch specifications

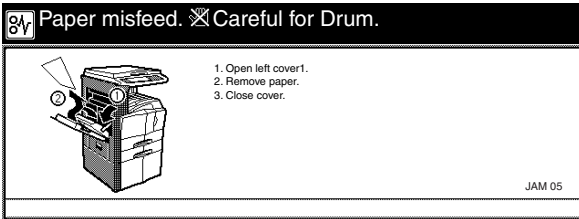

Metric specifications

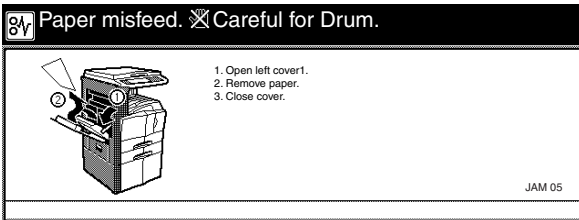

NOTE

The drum area inside the copier is extremely sensitive to dirt and damage. When removing the jammed paper, be sure not to touch the drum area that is located inside the machine with your hands, or with jewelry such as watches and rings, etc.

- 1 Pull up the left cover 1 handle to open the left cover 1.

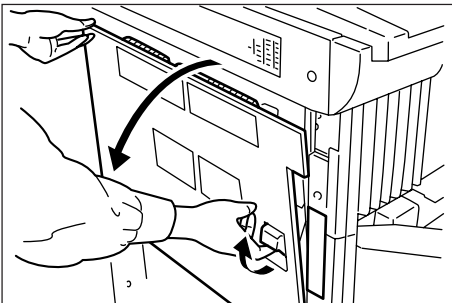

- 2 Remove the misfed paper.

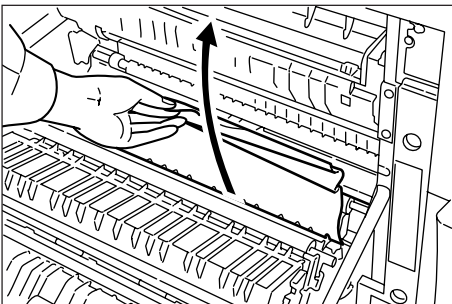

- 3 Raise the duplex unit to remove the misfed paper.

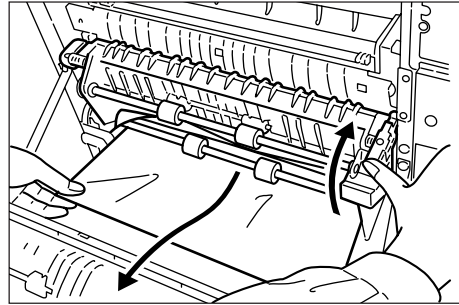

- 4 Remove the misfed paper in the output section.

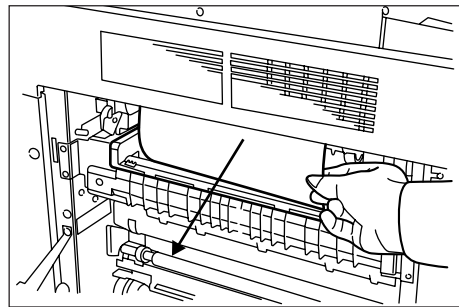

CAUTION

The copier's fixing unit is extremely hot. Take sufficient care when working in this area, as there is a danger of getting burned.

- 5 Close the left cover 1.

- 6** Press the [Start] key after the “Press Start Key. Re-starting.” message appears.
If the message below appears, proceed to the next step.

Inch specifications

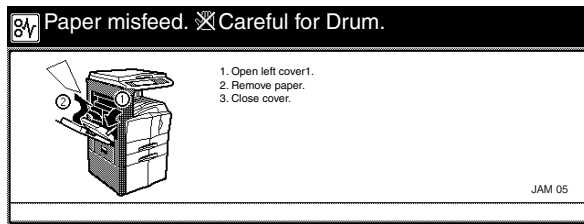

Metric specifications

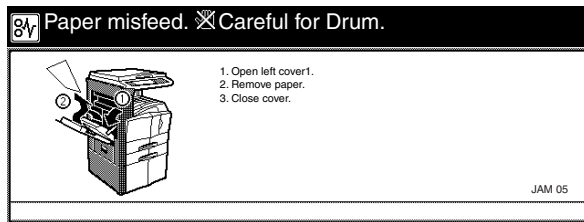

- 7** Repeat the steps 1 to 5.

- 8** The message below appears. Perform the appropriate action by following the message.

Inch specifications

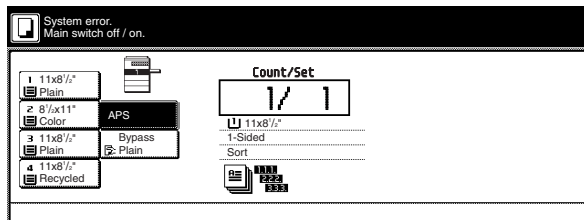

Metric specifications

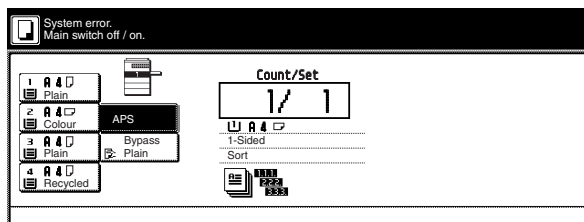

- 9** When the optional Fax Kit is installed, the message below appears. Perform the appropriate action by following the message.

Inch specifications

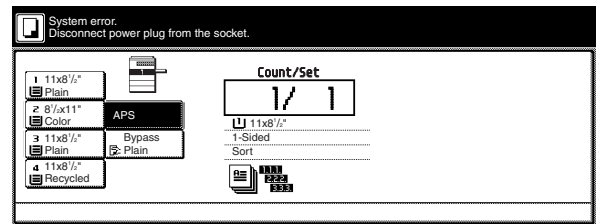

Metric specifications

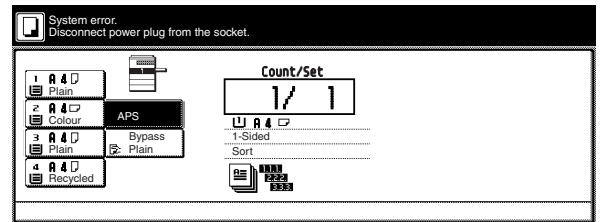

- **Misfeed in left cover 2 (JAM 18, 22)**

If the message below appears, a misfeed has occurred in the left cover 2. Remove the misfed paper using the procedure given below.

Inch specifications

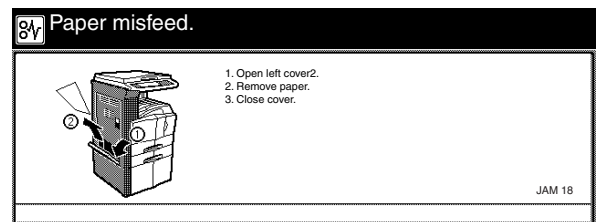

Metric specifications

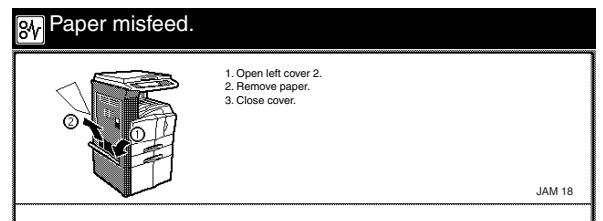

- 1** Open the left cover 2.

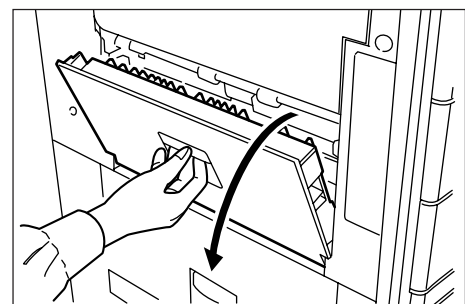

Section 9 TROUBLESHOOTING

- 2** Remove the misfed paper.

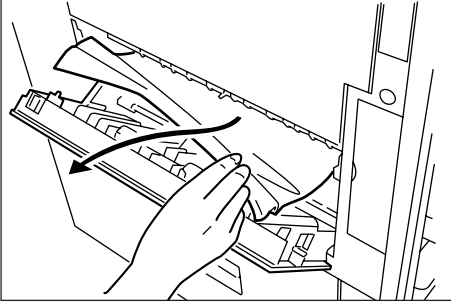

- 2** Pull up the lever to remove the misfed paper.
If the misfed paper cannot be removed, go to the next step.

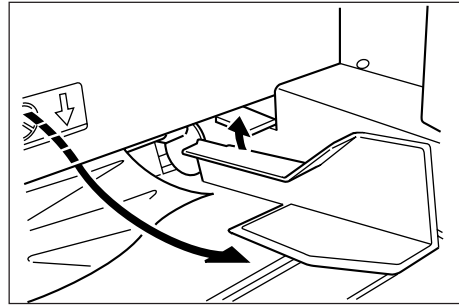

- 3** Close the left cover 2.

• **Misfed in multi-bypass tray (JAM14, 20, 21, 23)**

If the message below appears, a misfeed has occurred in the multi-bypass tray.

Remove the misfed paper using the procedure given below.

Inch specifications

Paper misfeed.

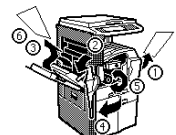

1. Remove paper in bypass.
2. Open left cover 1.
3. Remove paper.
4. Open front cover if you can not remove paper.
5. Turn right the green knob.
6. Remove paper.
7. Close the cover.

Metric specifications

Paper misfeed.

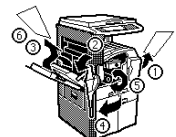

1. Remove paper in bypass.
2. Open left cover 1.
3. Remove paper.
4. Open front cover if you can not remove paper.
5. Turn green knob clockwise.
6. Remove paper.
7. Close cover.

- 1** Remove all the paper remaining in the multi-bypass tray.

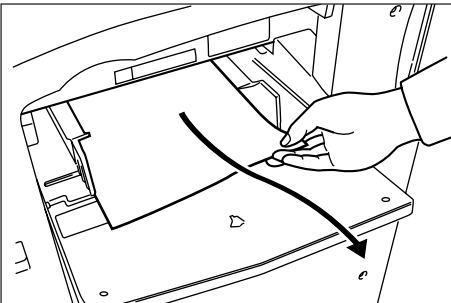

- 3** Pull up the left cover 1 handle to open the left cover 1.

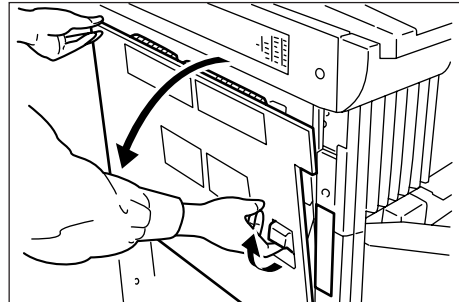

- 4** Remove the misfed paper.

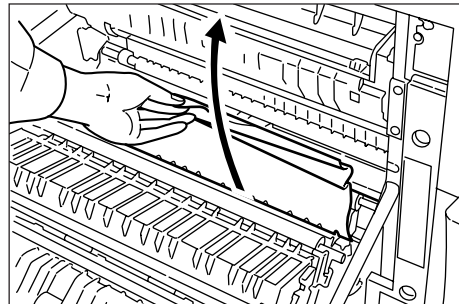

- 5** Raise the duplex unit to remove the misfed paper.
If the misfed paper cannot be removed, go to the next step.

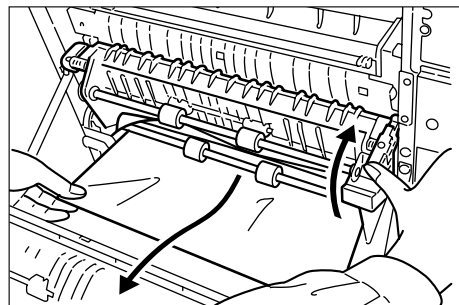

6 Open the front cover.

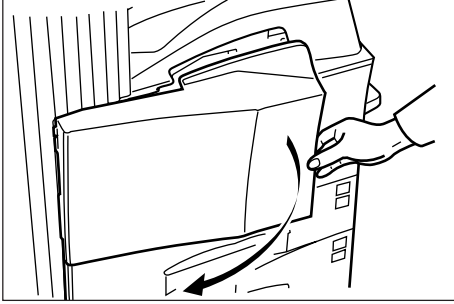

10 Open the internal tray cover to remove the misfed paper.



7 Turn the knob clockwise to release the misfed paper from the internal tray section.

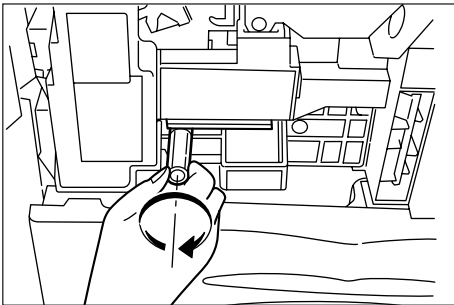

11 If the paper has been torn, remove the internal tray.

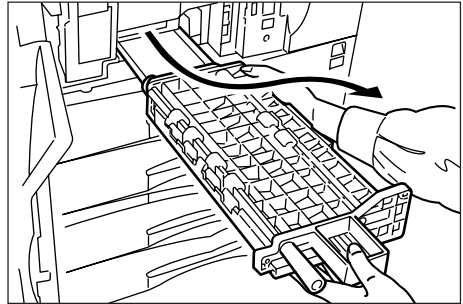

8 Remove the misfed paper.
If the misfed paper cannot be removed, go to the next step.

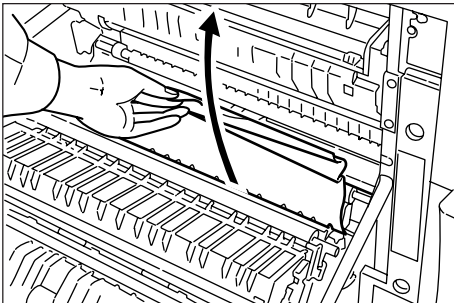

12 Remove the misfed paper.

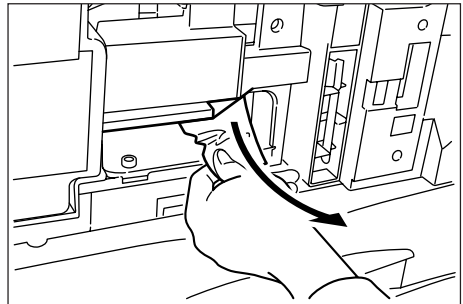

9 Pull out the internal tray.

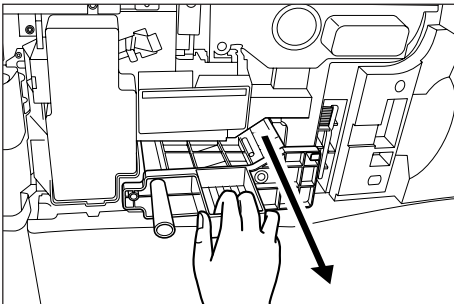

13 Replace the internal tray in its original position.
Close the front cover.

Section 9 TROUBLESHOOTING

② Misfeed in Document Processor (optional) (JAM 70 to 76)

If the message below appears, a misfeed has occurred in the Document Processor. Remove the misfed original using the procedure given below.

Inch specifications

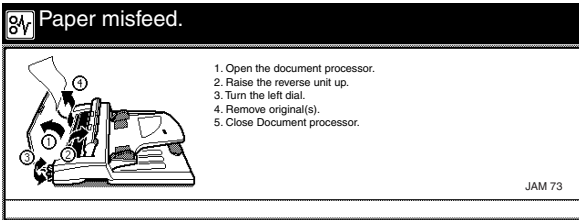

Metric specifications

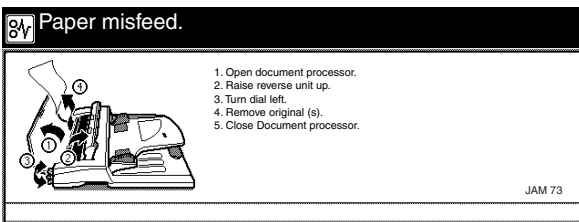

- 1** If the original is on the original table, remove it.

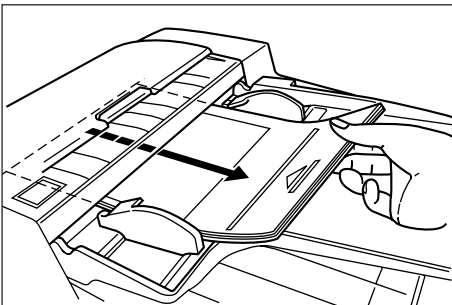

- 2** Open the Document Processor original cover.

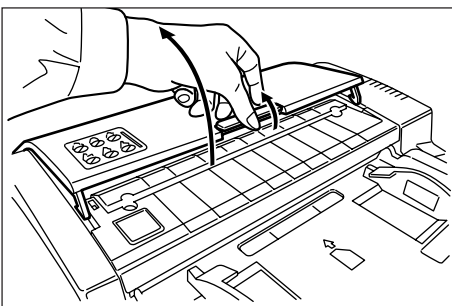

- 3** If the misfed original is found, remove it.
* If paper is torn during removal, be sure to remove all loose scraps from inside the copier, or they could cause misfeed later.

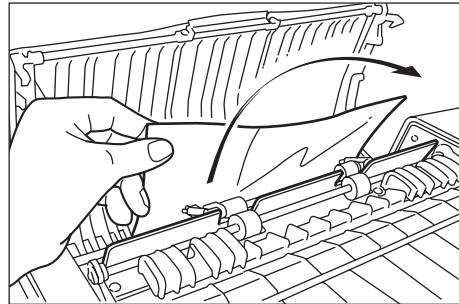

- 4** Raise the reversing unit.

- 5** If the misfed original is found, remove it.
* If paper is torn during removal, be sure to remove all loose scraps from inside the copier, or they could cause misfeed later.

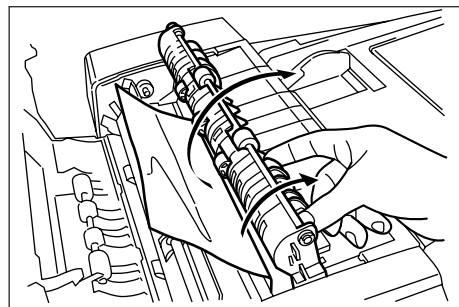

- 6** Turn the left knob to eject and remove the misfed original.

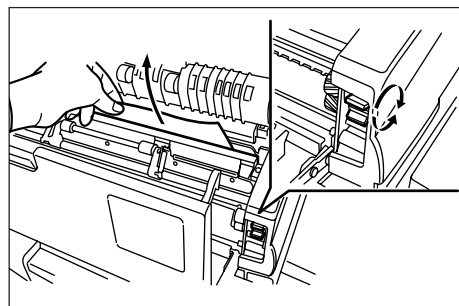

- 7** Close the Document Processor original cover.

③ Misfeed in Built-in Finisher (optional) (JAM 80 to 84)

If the message below appears, a misfeed has occurred in the Built-in Finisher. Remove the misfed paper using the procedure below.

Inch specifications

CAUTION Paper misfeed.

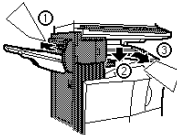

1. Remove any paper in output part of Finisher
2. Pull the tray of finisher down.
3. Remove the paper if there is a paper.
4. Set the tray

JAM 84

CAUTION Paper misfeed. **⚠ Careful for Drum.**

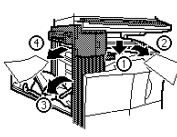

1. Lower inner tray of finisher.
2. Remove the paper.
3. Remove the eject tray, open left cover of machine.
4. Remove the paper.
5. Close cover and set the tray.

JAM 83

Metric specifications

CAUTION Paper misfeed.

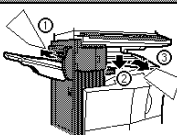

1. Remove any paper in output part of Finisher.
2. Put Finisher tray down.
3. Remove any paper.
4. Set tray back.

JAM 84

CAUTION Paper misfeed. **⚠ Careful for Drum.**

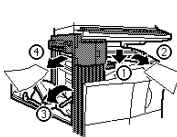

1. Put inner tray of Finisher down.
2. Remove any paper.
3. Remove output tray, open left cover of machine.
4. Remove paper.
5. Close cover and set tray.

JAM 83

NOTE

The drum area inside the copier is extremely sensitive to dirt and damage. When removing the jammed paper, be sure not to touch the drum area that is located inside the machine with your hands, or with jewelry such as watches and rings, etc.

1 Remove the misfed paper in the Built-in Finisher output section.

2 Lower the Built-in Finisher tray.

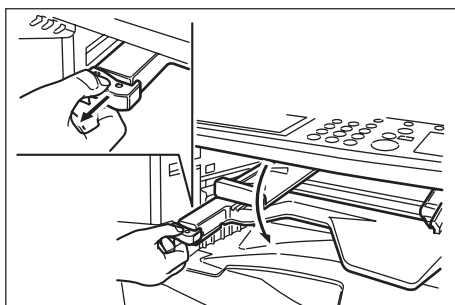

3 Remove the misfed paper.

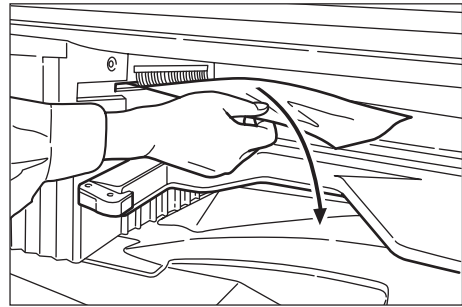

4 Raise the Built-in Finisher tray back into its original position.

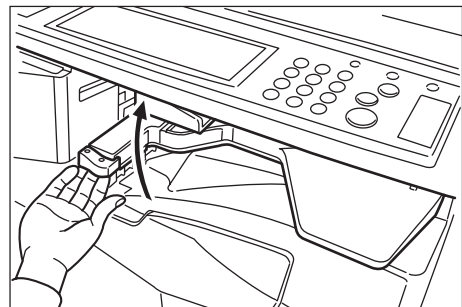

5 Remove the tray.

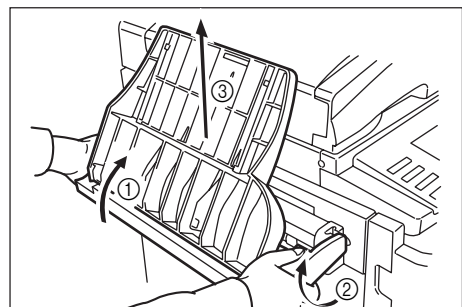

6 Pull up the left cover 1 handle to open the left cover 1.

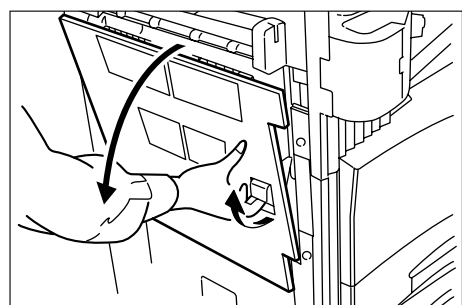

Section 9 TROUBLESHOOTING

- 7** Remove the misfed paper.

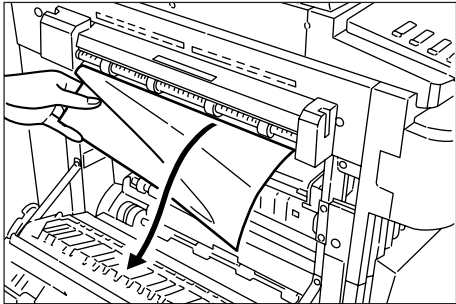

- 8** Install the tray.

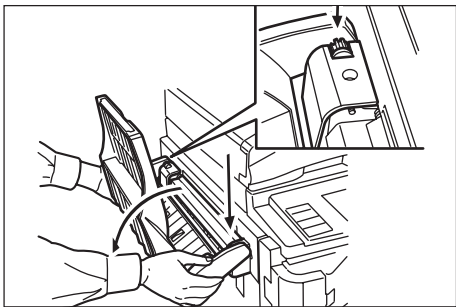

- 9** Close the left cover 1.

④ Misfed in Document Finisher (optional) (JAM 80 to 89)

If a misfeed has occurred in the Document Finisher, remove the misfed paper referring to the Operation Guide for the Document Finisher.

4. If other trouble occurs

If trouble occurs with your copier, carry out the applicable checkpoints and procedures indicated on the following pages. If the trouble persists, contact your service representative or authorized service center.

| Trouble | Checkpoint | Procedure | Reference page |
|---|--|---|----------------------|
| Nothing lights on the operation panel when the power switch is turned ON. | Is the power plug connected to an AC outlet? | Connect the plug to an AC outlet. | — |
| No copies come out when the [Start] key is pressed. | Is there any message appearing on the message display? | Perform the corrective action corresponding to the message. | 9-1 |
| Copies come out blank. | Are the originals set correctly? | When setting originals on the platen, place them face-down. | 4-1 |
| | | When setting originals in the optional Document Processor, place them face-up. | 8-2 |
| Copies come out too light. | Is the copier in the auto exposure mode? | To change the overall exposure, perform the auto exposure adjustment. | 7-73 |
| | Is the copier in the manual exposure mode? | Adjust the exposure to the correct degree using the copy exposure adjustment keys. | 4-2 |
| | | To change the overall exposure, perform the exposure adjustment for the each copy quality mode. | 7-75 7-76 7-77 |
| | Is the add toner message displayed? | Replace the toner container. | 10-3 |
| | Is paper wet? | Replace the paper with new paper. | 3-1 |

Section 9 TROUBLESHOOTING

| Trouble | Checkpoint | Procedure | Reference page |
|--|---|---|----------------------|
| Copies come out too dark. | Is the copier in the auto exposure mode? | To change the overall exposure, perform the auto exposure adjustment. | 7-73 |
| | Is the copier in the manual exposure mode? | Adjust the exposure to the correct degree using the copy exposure adjustment keys. | 4-2 |
| | | To change the overall exposure, perform the exposure adjustment for the each copy quality mode. | 7-75 7-76 7-77 |
| Copies are dirty. | Is the platen or the original cover dirty? | Clean the platen and/or the original cover. | 10-1 |
| | | Open the front cover and pull and push back in the cleaning shaft. | 10-5 |
| | Is the transfer roller contaminated? | Clean the transfer roller with the cleaning brush. | 10-2 |
| Copy image is askew. | Are the originals set correctly? | When setting originals on the platen, align their edges with the correct original size scale for their size. | 4-1 |
| | | When setting originals in the optional Document Processor, adjust the original insertion guides to the size of the originals correctly. | 8-2 |
| Misfeed occurs frequently. | Is the paper set correctly in the drawer[cassette]? | Set paper properly. | 3-1 |
| | Is paper curled, folded or wrinkled? | Replace the paper with new paper. | 3-1 |
| | Is there any misfed paper or loose scraps of paper remaining inside the copier? | Carry out the appropriate procedure to remove the paper. | 9-4 |
| Copies are wrinkled. | Is the separation in the paper feed section dirty? | Clean the separator. | 10-1 |
| Black or white lines appear on the copy. | Is the electrostatic section dirty? | Open the front cover and pull and push back in the cleaning shaft. | 10-5 |

Section 10 MAINTENANCE AND OPERATION INFORMATION

1. Cleaning the copier



CAUTION

For safety purposes, ALWAYS remove the power plug from the outlet when performing cleaning operations.

● Cleaning the original cover

Lift open the original cover. Wipe the back side of the original cover with a soft cloth dampened with alcohol or a mild detergent.

* Never use thinner or other organic solvents for this purpose.

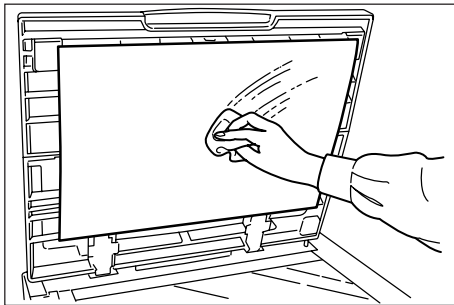

● Cleaning the platen

Lift open the original cover. Wipe the platen with a soft cloth dampened with alcohol or a mild detergent.

* Never use thinner or other organic solvents for this purpose.

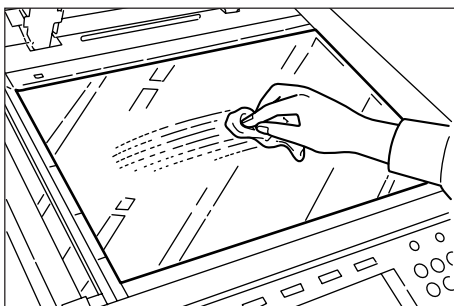

* If soiling, such as black lines appear on the copy while using the optional Document Processor, the slit glass (a) is soiled.

Wipe the slit glass with a soft dry cloth.

* Never use water, thinner, organic solvents or alcohol.

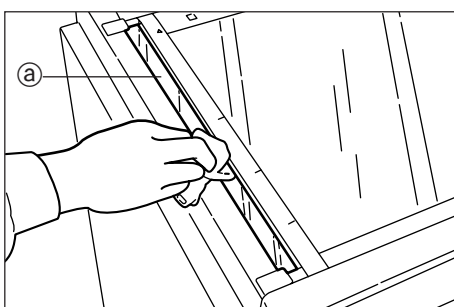

NOTE

When the slit glass becomes dirty, "Clean the slit glass for original fed from DP." ["Clean the slit glass for original fed."] may appear. In this case, perform the cleaning operation on the slit glass and then touch the "End" key.

Inch specifications

! Clean the slit glass for original fed from DP.

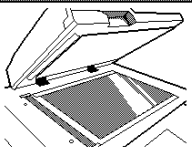

1. Open the document processor.
2. Clean the surface of narrower glass located at left with a dry cloth.
3. Please close the document processor.
4. Press END key

If the slit glass is dirty, black line will appear on the copy.

End

Metric specifications

! Clean the slit glass for original fed.

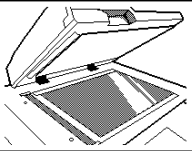

1. Open the document processor.
2. Clean the surface of narrower glass located at left with a dry cloth.
3. Please close the document processor.
4. Press END key

If the slit glass is dirty, black line will appear on the copy.

End

● Cleaning the separator

NOTE

To keep the best copying quality, perform cleaning periodically (approximately once a month) using the following procedure.

- 1** Open the front cover.

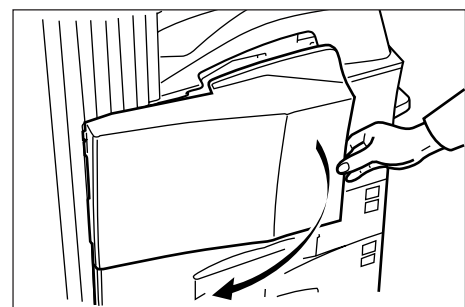

Section 10 MAINTENANCE AND OPERATION INFORMATION

- 2** Remove the blue cleaning brush.

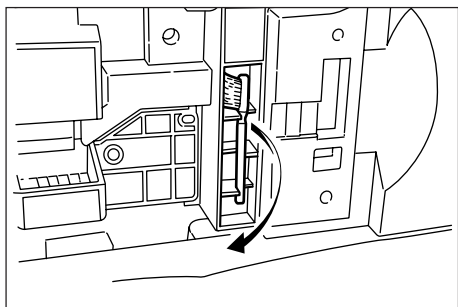

- 3** Pull up the left cover 1 handle to open the left cover 1.

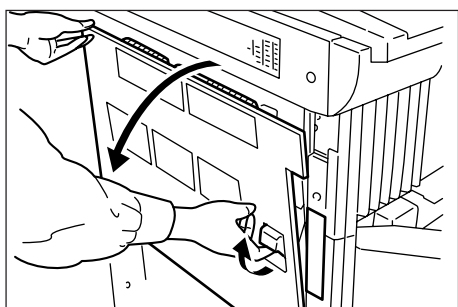

- 4** Clean the separator by moving the cleaning brush from left and right several times along the separator as shown in the illustration.

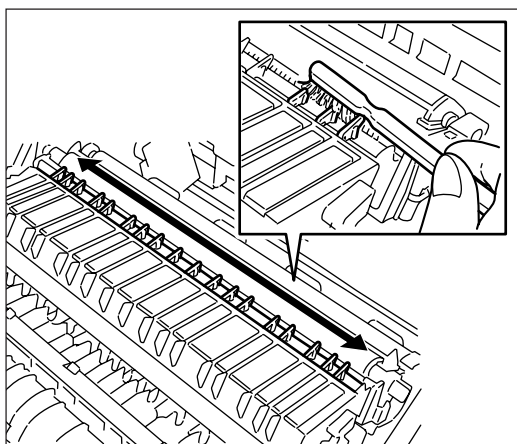

- 5** Once the cleaning operation is completed, return the cleaning brush to the copier and close both the left cover 1 and the front cover.

● Cleaning the transfer roller

- 1** Open the front cover.



- 2** Remove the blue cleaning brush.

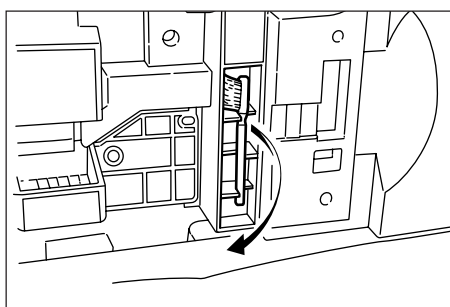

- 3** Pull up the left cover 1 handle to open the left cover 1.

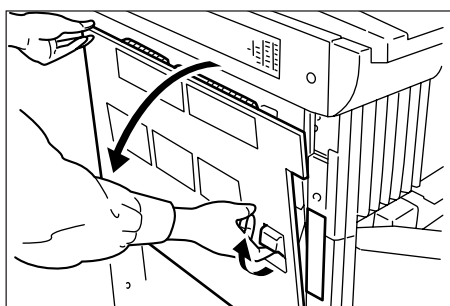

- 4** While rotating the gear as shown, clean the transfer roller by moving the cleaning brush from left to right along with the transfer roller.

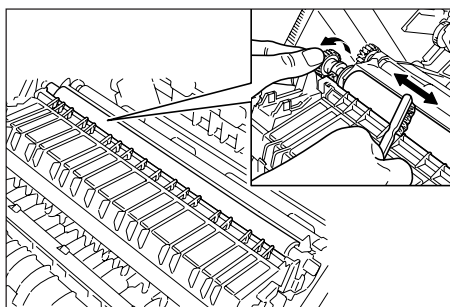

- 5** Once the cleaning operation is completed, return the cleaning brush to the copier and close both the left cover 1 and the front cover.

2. Replacing the toner container and waste toner box

If “Add toner to resume copying.” appears on the message display, replenish the toner. Although several copies can be made after the message appears, it is recommended that you replace the toner container immediately. After replacing the toner container, be sure to also replace the waste toner box.

Also be sure to clean the related parts when you replace a toner container. Dirty parts can cause lower performance by your copier.

IMPORTANT!

- Replenish toner only when the message is displayed.
- When replacing a toner container, do not leave any items such as floppy disks, etc., nearby.

Inch specifications

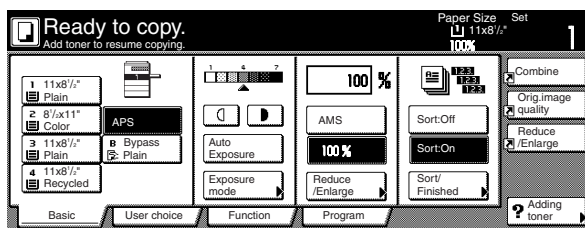

Metric specifications

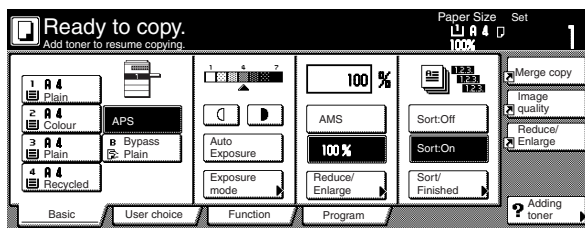

- 2 Push up the toner container release lever and slowly pull the old toner container out until the handle can be seen.

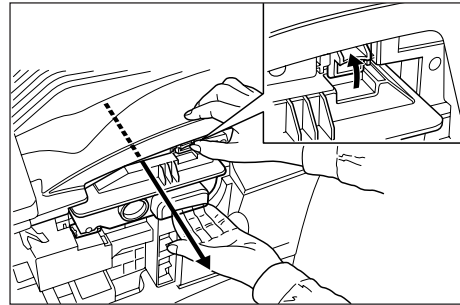

! WARNING

High voltage is present in the charger section. Take sufficient care when working in this area, as there is a danger of electrical shock.

! CAUTION

Do not pull the toner container all the way as it can fall off.

- 3 Grasp the handle on the toner container, push the left cover 1 handle up again and gently lift the toner container.

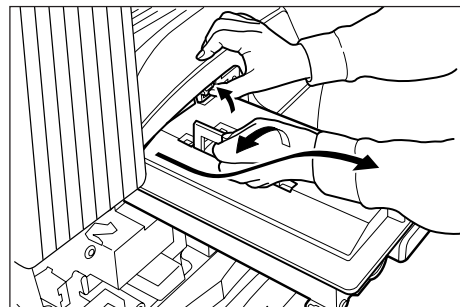

! CAUTION

DO NOT attempt to incinerate the toner container or the waste toner box. Dangerous sparks may cause burns.

! CAUTION

DO NOT attempt to force open or destroy the toner container or the waste toner box.

- 1 Open the front cover.

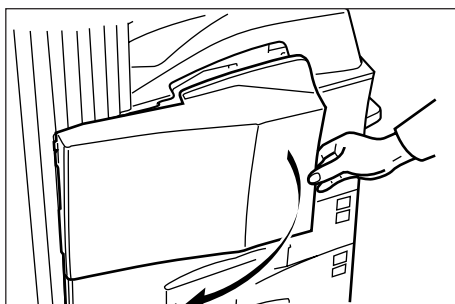

Section 10 MAINTENANCE AND OPERATION INFORMATION

- 4** Take out the new toner container from the bag, and then tap it on the top 5 to 6 times.

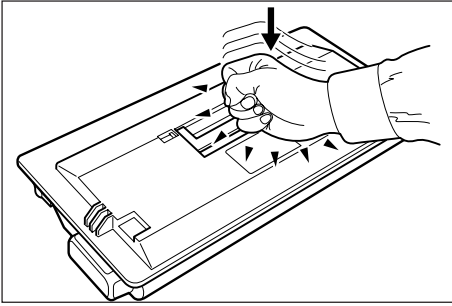

- 5** Thoroughly shake the toner container (in the direction of the arrow) ten times or more to loosen and mix the toner inside.

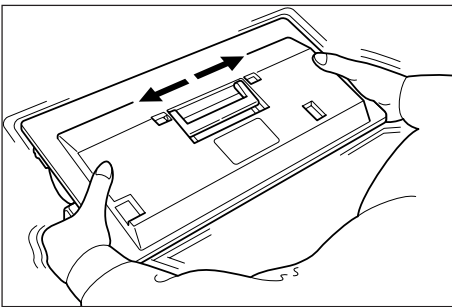

- 6** Grasp the handle on the toner container and insert the toner container along the rail of the copier.

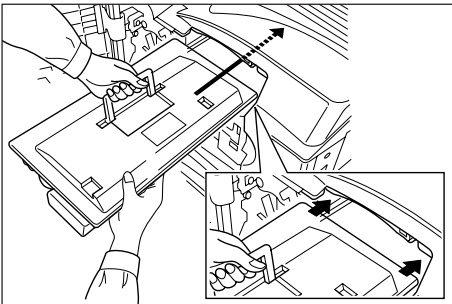

- 7** Hold the toner container by hands and fully insert it into the copier.

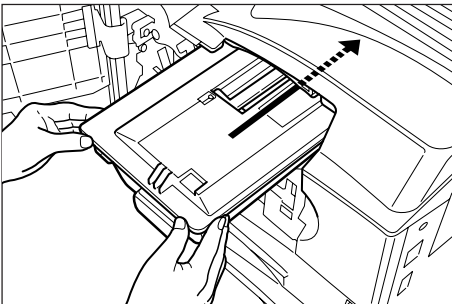

- 8** Remove the waste toner box.

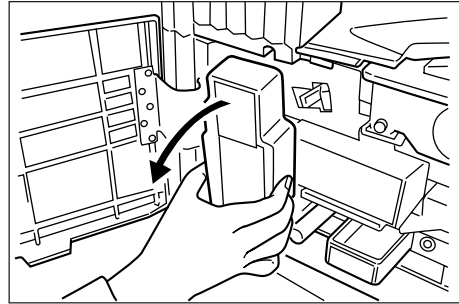

- 9** Close the opening of the waste toner box with its seal.

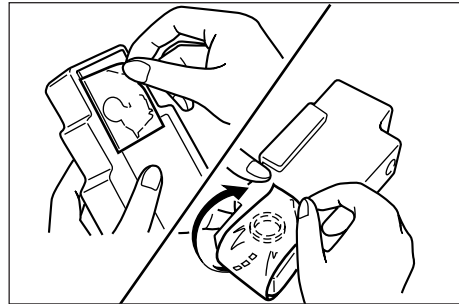

! CAUTION

DO NOT attempt to incinerate the toner container or the waste toner box. Dangerous sparks may cause burns.

! CAUTION

DO NOT attempt to force open or destroy the toner container or the waste toner box.

<Cleaning the related parts>

- 10** Push the electrostatic section (with the blue handle) to the right and then pull it out about 2 inches (5 cm).

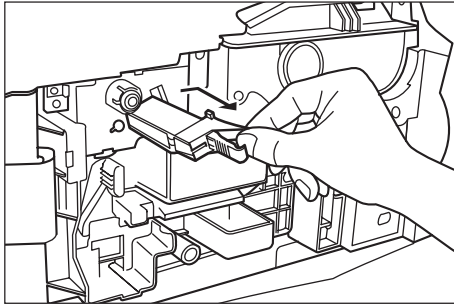

- 11** Remove the cap from the grid cleaner.

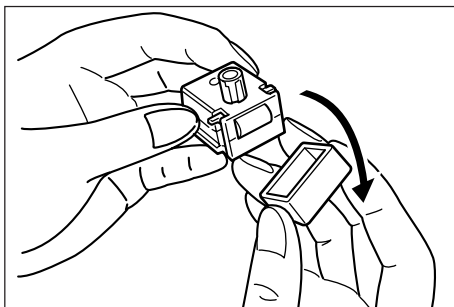

- 12** Attach the grid cleaner to the machine body aligning with the notches.

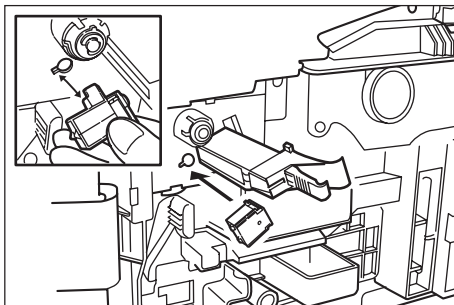

- 13** Pull the electrostatic section out as far as it will go and then push it back into the copier to a point just BEFORE the roller (A) touches the white pad of the grid cleaner. Repeat this step a few times.

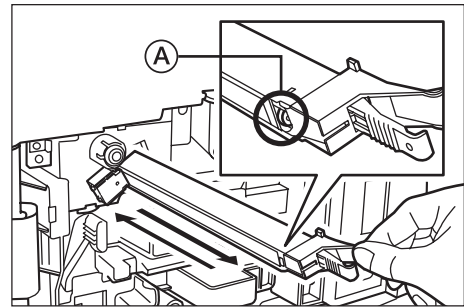

IMPORTANT!

DO NOT push the electrostatic section all the way back into the copier in this step as that may result in problems appearing in the printed images.

- 14** With the electrostatic section pulled out about 2 inches (5 cm), remove the grid cleaner and then push the electrostatic section all the way back into the copier.

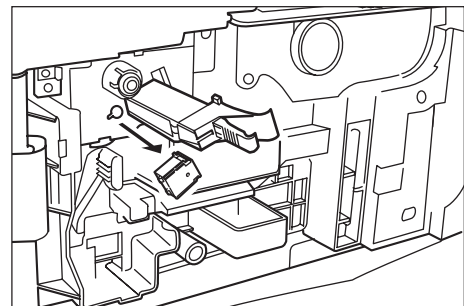

- 15** Fit the new waste toner box into the copier.

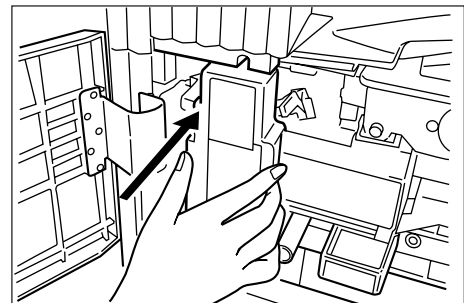

Section 10 MAINTENANCE AND OPERATION INFORMATION

- 16** Gently pull out the cleaning shaft (with the green handle) as far as it will go and then push it back into the copier. Repeat this step a few times.

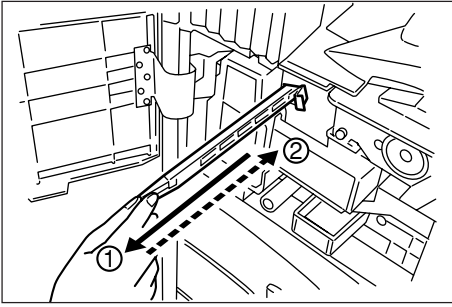

IMPORTANT!

Do not pull the cleaning shaft with force or pull it out completely.

- 17** Remove the blue cleaning brush.

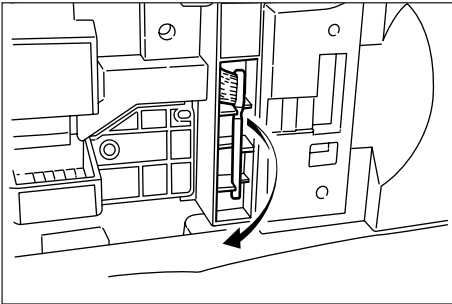

- 18** Pull up the left cover 1 handle to open the left cover 1.

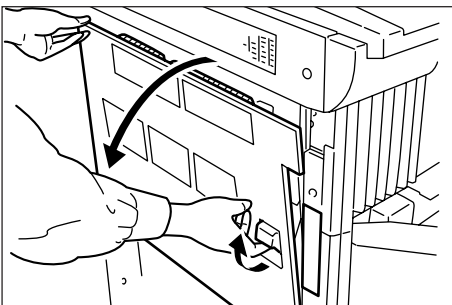

- 19** Clean the separator by moving the cleaning brush from left and right several times along the separator as shown in the illustration.

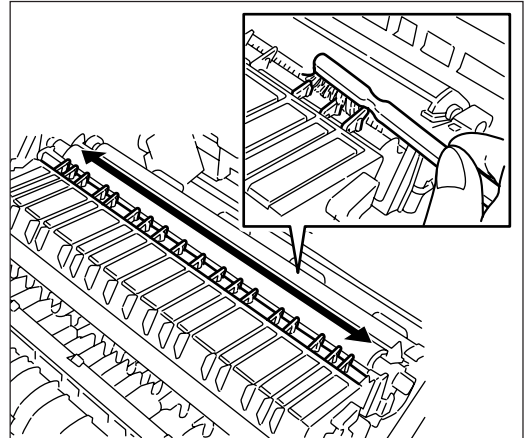

- 20** Once the cleaning operation is completed, return the cleaning brush to the copier and close both the left cover 1 and the front cover.

IMPORTANT!

Wait about 5 minutes after the cleaning operation is completed for the electrostatic section to dry before attempting to start copying again.

NOTE

To keep the best copying quality, perform cleaning of steps 15 and 18 described above periodically (approximately once a month) in addition to the time of toner container replacement.

- After use, ALWAYS dispose of the toner container and the waste toner box in accordance with Federal, State and Local rules and regulations.

3. Specifications

| | |
|------------------------------------|--|
| Type | Desk-top |
| Original table | Fixed type |
| Copying system | Indirect electrostatic |
| Originals | Sheets, books and 3-dimensional objects (Maximum original size: 11" x 17"/A3) |
| Copy sizes | Drawers[Cassettes]: 11" x 17" / A3, 8 1/2" x 14" / B4 (257 mm x 364 mm), 11" x 8 1/2" / A4, 8 1/2" x 11" / A4R, 5 1/2" x 8 1/2" / A5R, 8 1/2" x 13", Folio, 8K and 16K, B5, and B5R (Asia Pacific specification copiers) Multi-bypass tray: 11" x 17" / A3, 8 1/2" x 14" / B4 (257 mm x 364 mm), 11" x 8 1/2" / A4, 8 1/2" x 11" / A4R, 5 1/2" x 8 1/2" / A5R, A6R, 8 1/2" x 13", Folio, 8K and 16K, B5, and B5R (Asia Pacific specification copiers) For 2-sided copying: 11" x 17" / A3 – 5 1/2" x 8 1/2" / A5R Print margin loss: 0.5 mm – 5.5 mm |
| Copying speed | 30 cpm copiers: Same-size copying/memory copying; 11" x 17"/A3: 20 copies/min., 8 1/2" x 14"/B4: 20 copies/min., 11" x 8 1/2"/A4: 30 copies/min., 8 1/2" x 11"/A4R: 22 copies/min., B5: 30 copies/min., B5R: 18 copies/min. 40 cpm copiers: Same-size copying/memory copying; 11" x 17"/A3: 23 copies/min., 8 1/2" x 14"/B4: 23 copies/min., 11" x 8 1/2"/A4: 40 copies/min., 8 1/2" x 11"/A4R: 27 copies/min., B5: 40 copies/min., B5R: 22 copies/min. 50 cpm copiers: Same-size copying/memory copying; 11" x 17"/A3: 26 copies/min., 8 1/2" x 14"/B4: 26 copies/min., 11" x 8 1/2"/A4: 50 copies/min., 8 1/2" x 11"/A4R: 31 copies/min., B5: 50 copies/min., B5R: 24 copies/min. |
| Warm-up time | Within 25 seconds (at room temperature of 73.4°F (23°C), humidity 50%RH) From Low power mode: Within 12 seconds |
| First copy time | 30 cpm copiers: From 3.9 seconds (11" x 8 1/2"/A4) 40 cpm copiers, 50 cpm copiers: From 3.5 seconds (11" x 8 1/2"/A4) |
| Zoom ratio | Any ratio between 25 and 400% (in increments of 1%). Alternatively, standard ratios. |
| Standard amount of memory | 64 MB |
| Resolution | Reading: 600 x 600 dpi Writing: 600 x 600 dpi |
| Paper feed system | Automatic feeding from drawers[cassettes] (2 drawers[cassettes], capacity 500 sheets each [80 g/m ² /standard paper specified by our company]), automatic feeding from multi-bypass (capacity 200 sheets [80g/m ²]) |
| Copy paper | <Paper weights> Drawers[Cassettes]: 60 g/m ² – 105 g/m ² Duplex Unit: 64 g/m ² – 80 g/m ² Multi-bypass tray: 45 g/m ² – 200 g/m ² ; 110 lbs. <Paper types> Drawers[Cassettes]: Standard copy paper and color paper Duplex Unit: Standard copy paper and color paper Multi-bypass tray: Standard copy paper, letterhead, color paper, tracing paper, OHP transparencies, envelopes, etc. |
| Continuous copying | 1 – 999 sheets |
| Light source | Rare gas lamp |
| Developing system | Dry process |
| Fixing system | Heat roller |
| Cleaning system | Blade and cleaning roller |
| Photoconductor | a-Si |
| Standard functions and modes | Auto paper selection mode, Image quality selection, Auto magnification selection mode, Zoom mode, Preset zoom mode, XY zoom mode, 2-sided copy modes, Page separation/ Split copy modes, Margin mode, Centering/Image shift mode, Memo mode, Border erase modes, Combine/Merge Copy modes, Print page numbers mode, Form overlay mode, Booklet/Stitching mode, Book to Booklet mode, Sort/Finished mode, Auto rotation function, Cover mode, Transparency + backing sheet mode, Invert mode, Mirror image mode, Proof mode, Repeat copy mode*, Batch scanning mode, Eco print mode, Program function, Job build mode, Form registration*, Shared data box*, Synergy print boxes*, Copy management mode, Language selection function * Requires the optional Hard Disk |

Section 10 MAINTENANCE AND OPERATION INFORMATION

| | |
|--------------------------|---|
| Power source | Inch specifications: 120 V AC, 60 Hz, 12 A Max. Metric specifications: 220-240 V AC, 50 or 60 Hz, 6.5 A Max. |
| Dimensions | 23"(W) x 25 2/5"(D) x 29 1/3"(H) 585 mm (W) x 646 mm (D) x 745 mm (H) |
| Weight | Approx. 165 lbs. Approx. 82 kg |
| Noise emission | ≤ 70dB (A) |
| Required space | 23"(W) x 25 2/5"(D) 585 mm (W) x 646 mm (D) |
| Optional equipment | Document Processor, Paper Feeder, Document Finisher, Bult-in Finisher, Job Separator, Hard Disk, Key Counter, Document Tray, Printer Kit, Printer/Scanner Kit, Fax Kit |

(Specifications are subject to change without notice.)

4. Environmental Specifications

● Power consumption

| | 30 cpm copiers | | 40 cpm copiers | | 50 cpm copiers | |
|--|---------------------|-----------------------|---------------------|-----------------------|---------------------|-----------------------|
| | Inch specifications | Metric specifications | Inch specifications | Metric specifications | Inch specifications | Metric specifications |
| • During copying | 670 wh or less | 670 wh or less | 685 wh or less | 685 wh or less | 720 wh or less | 760 wh or less |
| • During standby | 175 wh or less | 200 wh or less | 175 wh or less | 200 wh or less | 175 wh or less | 200 wh or less |
| • During the Low Power mode | 75 wh or less | 75 wh or less | 75 wh or less | 75 wh or less | 75 wh or less | 75 wh or less |
| • Recovery time from the Low Power mode | 12 seconds or less | 12 seconds or less | 12 seconds or less | 12 seconds or less | 12 seconds or less | 12 seconds or less |
| • During the Off and Sleep mode | 0.1 wh or less | 0.1 wh or less | 0.1 wh or less | 0.1 wh or less | 0.1 wh or less | 0.1 wh or less |
| • Transition time to the Low Power mode (at time of purchase) | 15 minutes | 15 minutes | 15 minutes | 15 minutes | 15 minutes | 15 minutes |
| • Transition time to the Off and Sleep modes (at time of purchase) | 60 minutes | 60 minutes | 60 minutes | 60 minutes | 60 minutes | 60 minutes |
| • During the Plugged-In mode | 0.1 wh or less | 0.1 wh or less | 0.1 wh or less | 0.1 wh or less | 0.1 wh or less | 0.1 wh or less |

* Power consumption in the Plugged-In mode can only be terminated by removing the power plug from the outlet.

● Duplex (2-sided) copying

- Comes as standard equipment

● Paper feed

- Recycled paper made from 100% recycled pulp may be used with this product.
- * Contact your sales or service representative for information on recommended paper types, etc.

5. Installing the optional equipment

This section shows where to install the optional units for this copier. For more details, refer to the Operation Guide for the corresponding optional unit.

● **Available optional units**

The following optional units can be installed on your copier.

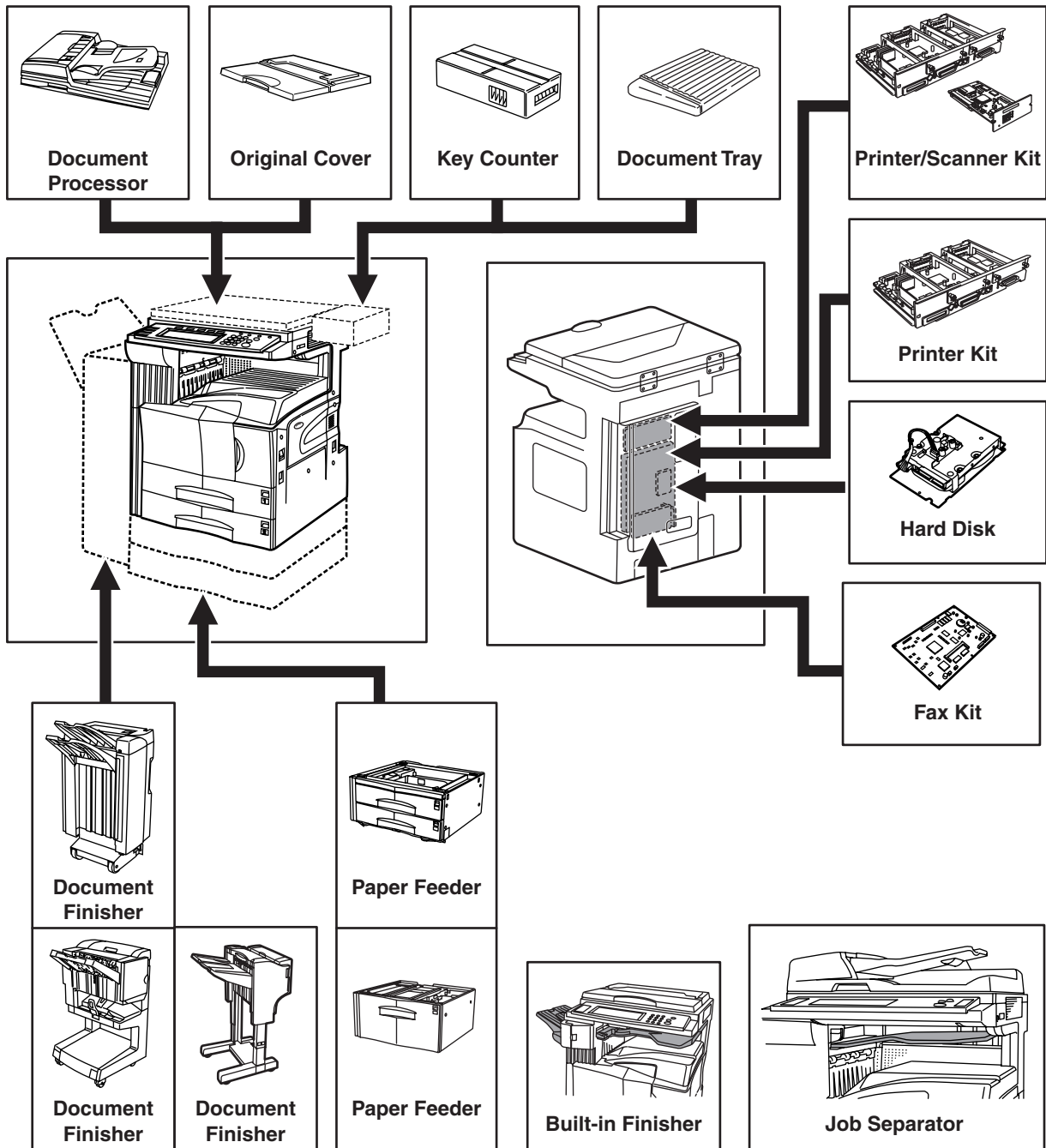

Document Processor

The Duplex Document Processor automatically feeds one-sided originals one by one for scanning. It also reverses two-sided originals automatically for duplex copying and page separation copying.

Paper Feeder

Two Paper Feeders of the same type as drawer[cassette] in the main body can be added. Capacity and the paper loading method is the same as those for the standard drawer[cassette] in the main unit.

Paper Feeder

The Paper Feeder holds up to 3,000 sheets of 11" x 8 1/2" [A4 or B5 (B5 is for Asia-Pacific specification copiers only)] size standard paper. Pull the Paper Feeder out towards you as far as it will go, and then load up to 1,500 sheets of paper in each row.

Document Finisher

This unit lets you store a large volume of copies and shifts the position of each copy set for ease of sorting. It can staple finished copy sets and bind them. It is also possible to use the Document Finisher to punch holes in them for filling purposes (optional).

Document Finisher

The Document Finisher stores a large quantity copies, and sorts multiple sets by shifting the position that each one is ejected. It is also possible to use the Document Finisher to staple the copy sets or punch holes in them for filling purposes.

Document Finisher

The Document Finisher stores a large quantity copies, and sorts multiple sets (Sort: ON) or groups copies made from multiple originals, with all the copies produced from an individual original grouped together in one set (Sort: OFF). It is also possible to use the Document Finisher to staple sorted copy sets.

Built-in Finisher

The finisher stores a large quantity of copies. It can also sorts multiple copies into sets by shifting the eject position. Paginated copies can be stapled, too.

Job Separator

When using the optional printer function, the paper eject point can be changed according to the used function, making it easier to sort paper. Copied paper can be ejected to the Job Separator (upper section). See "Copy eject location" in Machine default setting on page 7-49.

Hard Disk

The Hard Disk is required in order to use the following modes and functions of your copier.

- Job reservation
- Form overlay of registered forms
- Repeat copying
- Document management functions
- Using the output management functions to change the job printing order, cancel and delete print jobs, and verify content

It is also possible to register up to 1000 department ID-codes under document management.

Key Counter

The Key Counter determines the number of copies that have been made. It is useful for copier centralized management on a department or even company level.

Document Tray

The Document Tray lets you place originals and other documents next to the machine before using them, etc. It also contains space for storing paper clips, etc.

Printer Kit

If the Printer Kit is installed, this copier can be used as a printer.

Since the network board is equipped, this copier can also be used as a network printer, allowing access from multiple computers.

Printer/Scanner Kit

If the Printer/Scanner Kit is installed, this copier can be used as a printer or a network scanner.

Since the network board is equipped, this copier can also be used as a network printer, allowing access from multiple computers.

Fax Kit

If the Fax Kit is installed, this copier can be used as a fax. Also if the Fax Kit is used together with the optional Printer/Scanner Kit, this copier can be used as a network fax, allowing transmission and reception by a computer.

Appendix: Functions and settings combination chart

This copier contains many different functions and settings, and many of them can be used in combination for more efficient copying. Refer to the following chart for details on combining specific functions and settings.

○ : Combination is possible

---: Combination is NOT possible

- 01: Auto exposure adjustment is not available for the photo mode. The text&photo mode, the text mode, or manual exposure adjustment will be selected.
- 02: Only the auto magnification selection mode is available. That mode will be selected.
- 03: Only same size (100% [1:1]) copying in the auto paper selection mode is available. That mode will be selected.
- 04: The margin mode cannot be used in combination with the booklet/stitching mode or the book to booklet mode.
- 05: The margin mode cannot be used in combination with the combine/merge copy modes or the memo mode.

- 06: The border erase modes cannot be used in combination with original size selection (input size).
- 07: The border erase modes and the auto selection/filing mode cannot be used in combination with each other.
- 08: The book erase mode and the booklet/stitching mode cannot be used in combination with each other.
- 09: Not available because open-faced originals must be set with the top edge towards the rear of the platen.
- 10: The booklet/stitching mode and book to booklet mode will be given second priority when the 2-sided copy modes or the page separation/split copy modes are selected.

- 11: The transparency + backing sheet mode and the 2-sided copy modes cannot be used in combination with each other.
- 12: Cannot be used in combination with the auto selection/filing mode.
- 13: The 2-sided copy modes and the invert mode cannot be used in combination with each other.
- 14: Open-faced originals cannot be used in combination with original size selection.
- 15: The book g page separation/split copy mode cannot be used in combination with the combine/merge copy modes or the memo mode.

| Function selected first \ Function selected second | ① | ② | ③ | ④ | ⑤ | ⑥ | ⑦ | ⑧ | ⑨ | ⑩ | ⑪ | ⑫ | ⑬ | ⑭ | ⑮ | ⑯ | ⑰ | ⑱ | ⑲ | ⑳ | ㉑ | ㉒ | ㉓ | ㉔ |
|--|-----|-----|-----|-----|-----|-----|-----|-----|-----|-----|-----|-----|-----|-----|-----|-----|-----|-----|-----|-----|-----|-----|-----|-----|
| ① Image quality mode (text&photo) | --- | --- | --- | ○ | ○ | ○ | ○ | ○ | ○ | ○ | ○ | ○ | ○ | ○ | ○ | ○ | ○ | ○ | ○ | ○ | ○ | ○ | ○ | ○ |
| ② Image quality mode (photo) | --- | --- | 01 | ○ | ○ | ○ | ○ | ○ | ○ | ○ | ○ | ○ | ○ | ○ | ○ | ○ | ○ | ○ | ○ | ○ | ○ | ○ | ○ | ○ |
| ③ Image quality mode (text) | --- | --- | ○ | ○ | ○ | ○ | ○ | ○ | ○ | ○ | ○ | ○ | ○ | ○ | ○ | ○ | ○ | ○ | ○ | ○ | ○ | ○ | ○ | ○ |
| ④ Copy exposure mode (auto exposure) | ○ | 01 | ○ | --- | ○ | ○ | ○ | ○ | ○ | ○ | ○ | ○ | ○ | ○ | ○ | ○ | ○ | ○ | ○ | ○ | ○ | ○ | ○ | ○ |
| ⑤ Copy exposure mode (manual exposure) | ○ | ○ | ○ | --- | ○ | ○ | ○ | ○ | ○ | ○ | ○ | ○ | ○ | ○ | ○ | ○ | ○ | ○ | ○ | ○ | ○ | ○ | ○ | ○ |
| ⑥ Eco print mode | ○ | ○ | ○ | ○ | ○ | ○ | ○ | ○ | ○ | ○ | ○ | ○ | ○ | ○ | ○ | ○ | ○ | ○ | ○ | ○ | ○ | ○ | ○ | ○ |
| ⑦ Original size selection (standard size) | ○ | ○ | ○ | ○ | ○ | ○ | --- | --- | --- | ○ | ○ | ○ | ○ | ○ | ○ | ○ | ○ | ○ | 12 | 12 | ○ | ○ | ○ | ○ |
| ⑧ Original size selection (input size) | ○ | ○ | ○ | ○ | ○ | ○ | --- | --- | --- | ○ | ○ | ○ | ○ | ○ | ○ | ○ | ○ | ○ | 12 | 12 | ○ | ○ | ○ | ○ |
| ⑨ Original size selection (auto selection) | ○ | ○ | ○ | ○ | ○ | ○ | --- | --- | --- | ○ | ○ | ○ | ○ | ○ | ○ | ○ | ○ | ○ | ○ | ○ | ○ | ○ | ○ | ○ |
| ⑩ Original size selection (custom original size) | ○ | ○ | ○ | ○ | ○ | ○ | --- | --- | --- | ○ | ○ | ○ | ○ | ○ | ○ | ○ | ○ | ○ | 12 | 12 | ○ | ○ | ○ | ○ |
| ⑪ Same size (100% [1:1]) copying | ○ | ○ | ○ | ○ | ○ | ○ | ○ | ○ | ○ | ○ | ○ | --- | --- | --- | ○ | ○ | ○ | ○ | ○ | 03 | 02 | ○ | ○ | ○ |
| ⑫ XY zoom mode | ○ | ○ | ○ | ○ | ○ | ○ | ○ | ○ | ○ | ○ | ○ | --- | --- | --- | ○ | ○ | ○ | ○ | ○ | 03 | 02 | ○ | ○ | ○ |
| ⑬ Auto magnification selection mode | ○ | ○ | ○ | ○ | ○ | ○ | ○ | ○ | ○ | ○ | ○ | --- | --- | --- | ○ | ○ | ○ | ○ | ○ | 03 | ○ | ○ | ○ | ○ |
| ⑭ Zoom mode | ○ | ○ | ○ | ○ | ○ | ○ | ○ | ○ | ○ | ○ | ○ | --- | --- | --- | ○ | ○ | ○ | ○ | ○ | 03 | 02 | ○ | ○ | ○ |
| ⑮ Paper selection | ○ | ○ | ○ | ○ | ○ | ○ | ○ | ○ | ○ | ○ | ○ | ○ | ○ | ○ | ○ | ○ | ○ | ○ | ○ | 31 | ○ | ○ | ○ | ○ |
| ⑯ Original set direction | ○ | ○ | ○ | ○ | ○ | ○ | ○ | ○ | ○ | ○ | ○ | ○ | ○ | ○ | ○ | ○ | ○ | ○ | ○ | ○ | ○ | ○ | ○ | ○ |
| ⑰ Batch scanning mode | ○ | ○ | ○ | ○ | ○ | ○ | ○ | ○ | ○ | ○ | ○ | ○ | ○ | ○ | ○ | ○ | ○ | ○ | ○ | ○ | 27 | ○ | ○ | ○ |
| ⑱ Auto rotation function | ○ | ○ | ○ | ○ | ○ | ○ | ○ | ○ | ○ | ○ | ○ | ○ | ○ | ○ | ○ | ○ | ○ | ○ | ○ | ○ | ○ | ○ | ○ | ○ |
| ⑲ Auto selection/filing mode (auto selection) | ○ | ○ | ○ | ○ | ○ | ○ | 12 | 12 | ○ | 12 | 03 | 03 | 03 | 03 | 12 | ○ | ○ | ○ | ○ | --- | ○ | ○ | ○ | ○ |
| ⑳ Auto selection/filing mode (filing) | ○ | ○ | ○ | ○ | ○ | ○ | 12 | 12 | ○ | 12 | 02 | 02 | ○ | 02 | ○ | ○ | 33 | ○ | --- | ○ | ○ | ○ | ○ | ○ |
| ㉑ Proof mode | ○ | ○ | ○ | ○ | ○ | ○ | ○ | ○ | ○ | ○ | ○ | ○ | ○ | ○ | ○ | ○ | ○ | ○ | ○ | ○ | ○ | ○ | ○ | ○ |
| ㉒ Repeat copy mode (settings) | ○ | ○ | ○ | ○ | ○ | ○ | ○ | ○ | ○ | ○ | ○ | ○ | ○ | ○ | ○ | ○ | ○ | ○ | ○ | ○ | ○ | ○ | ○ | ○ |
| ㉓ Sort mode | ○ | ○ | ○ | ○ | ○ | ○ | ○ | ○ | ○ | ○ | ○ | ○ | ○ | ○ | ○ | ○ | ○ | ○ | ○ | ○ | ○ | ○ | ○ | ○ |
| ㉔ Finished mode | ○ | ○ | ○ | ○ | ○ | ○ | ○ | ○ | ○ | ○ | ○ | ○ | ○ | ○ | ○ | ○ | ○ | ○ | ○ | ○ | ○ | ○ | ○ | ○ |
| ㉕ Staple mode | ○ | ○ | ○ | ○ | ○ | ○ | ○ | ○ | ○ | ○ | ○ | ○ | ○ | ○ | ○ | ○ | ○ | ○ | ○ | 12 | ○ | ○ | ○ | --- |
| ㉖ Punch mode | ○ | ○ | ○ | ○ | ○ | ○ | ○ | ○ | ○ | ○ | ○ | ○ | ○ | ○ | ○ | ○ | ○ | ○ | ○ | ○ | ○ | ○ | ○ | ○ |
| ㉗ 2-sided copy modes (1 sided→1 sided) | ○ | ○ | ○ | ○ | ○ | ○ | ○ | ○ | ○ | ○ | ○ | ○ | ○ | ○ | ○ | ○ | ○ | ○ | ○ | ○ | ○ | ○ | ○ | ○ |
| ㉘ 2-sided copy modes (1 sided→2 sided) | ○ | ○ | ○ | ○ | ○ | ○ | ○ | ○ | ○ | ○ | ○ | ○ | ○ | ○ | ○ | ○ | ○ | ○ | ○ | 12 | ○ | ○ | ○ | ○ |
| ㉙ 2-sided copy modes (2 sided→2 sided) | ○ | ○ | ○ | ○ | ○ | ○ | ○ | ○ | ○ | ○ | ○ | ○ | ○ | ○ | ○ | ○ | ○ | ○ | ○ | ○ | ○ | ○ | ○ | ○ |
| ㉚ 2-sided copy modes (Book→2 sided) | ○ | ○ | ○ | ○ | ○ | ○ | 14 | 14 | ○ | 14 | ○ | ○ | ○ | ○ | ○ | ○ | 09 | ○ | ○ | 12 | 12 | ○ | ○ | ○ |
| ㉛ Page separation/Split copy modes (2 sided→1 sided) | ○ | ○ | ○ | ○ | ○ | ○ | ○ | ○ | ○ | ○ | ○ | ○ | ○ | ○ | ○ | ○ | ○ | ○ | ○ | ○ | ○ | ○ | ○ | ○ |
| ㉜ Page separation/Split copy modes (Book→1 sided) | ○ | ○ | ○ | ○ | ○ | ○ | 14 | 14 | ○ | 14 | ○ | ○ | ○ | ○ | ○ | ○ | 09 | ○ | ○ | 12 | 12 | ○ | ○ | ○ |
| ㉝ Booklet/Stitching mode | ○ | ○ | ○ | ○ | ○ | ○ | ○ | 20 | ○ | 20 | ○ | 02 | ○ | ○ | ○ | ○ | ○ | ○ | ○ | 12 | 12 | ○ | ○ | ○ |
| ㉞ Book to Booklet mode | ○ | ○ | ○ | ○ | ○ | ○ | ○ | 20 | ○ | 20 | 02 | 02 | ○ | 02 | ○ | 09 | ○ | ○ | ○ | 12 | 12 | ○ | ○ | ○ |
| ㉟ Margin mode | ○ | ○ | ○ | ○ | ○ | ○ | ○ | ○ | ○ | ○ | ○ | ○ | ○ | ○ | ○ | ○ | ○ | ○ | ○ | ○ | ○ | ○ | ○ | ○ |
| ㊱ Centering/Image shift mode | ○ | ○ | ○ | ○ | ○ | ○ | ○ | ○ | ○ | ○ | ○ | ○ | ○ | ○ | ○ | ○ | ○ | ○ | ○ | ○ | ○ | ○ | ○ | ○ |
| ㊲ Border erase modes (Sheet erase) | ○ | ○ | ○ | ○ | ○ | ○ | ○ | 06 | ○ | 06 | ○ | ○ | ○ | ○ | ○ | ○ | ○ | ○ | ○ | 07 | 07 | ○ | ○ | ○ |
| ㊳ Border erase modes (Individual border erase) | ○ | ○ | ○ | ○ | ○ | ○ | ○ | 06 | ○ | 06 | ○ | ○ | ○ | ○ | ○ | ○ | ○ | ○ | ○ | 07 | 07 | ○ | ○ | ○ |
| ㊴ Border erase modes (Book erase) | ○ | ○ | ○ | ○ | ○ | ○ | ○ | 06 | ○ | 06 | ○ | ○ | ○ | ○ | 09 | ○ | ○ | ○ | ○ | 07 | 07 | ○ | ○ | ○ |
| ㊵ Combine/Merge Copy modes | ○ | ○ | ○ | ○ | ○ | ○ | ○ | 32 | ○ | 32 | ○ | 02 | ○ | ○ | ○ | ○ | ○ | ○ | ○ | 12 | 12 | ○ | ○ | ○ |
| ㊶ Memo mode | ○ | ○ | ○ | ○ | ○ | ○ | ○ | 32 | ○ | 32 | ○ | 02 | ○ | ○ | ○ | ○ | ○ | ○ | ○ | 12 | 12 | ○ | ○ | ○ |
| ㊷ Form overlay mode | ○ | ○ | ○ | ○ | ○ | ○ | ○ | ○ | ○ | ○ | ○ | ○ | ○ | ○ | ○ | ○ | ○ | ○ | ○ | 12 | 12 | ○ | 35 | ○ |
| ㊸ Cover mode | ○ | ○ | ○ | ○ | ○ | ○ | ○ | 24 | ○ | 24 | ○ | ○ | ○ | ○ | ○ | ○ | ○ | ○ | ○ | 12 | 12 | ○ | ○ | ○ |
| ㊹ Transparency + backing sheet mode | ○ | ○ | ○ | ○ | ○ | ○ | ○ | 29 | ○ | 29 | ○ | ○ | ○ | ○ | ○ | ○ | ○ | ○ | ○ | 12 | 12 | ○ | ○ | 30 |
| ㊺ Print page numbers mode | ○ | ○ | ○ | ○ | ○ | ○ | ○ | ○ | ○ | ○ | ○ | ○ | ○ | ○ | ○ | ○ | ○ | ○ | ○ | 12 | 12 | ○ | ○ | ○ |
| ㊻ Invert mode | ○ | ○ | ○ | ○ | ○ | ○ | ○ | ○ | ○ | ○ | ○ | ○ | ○ | ○ | ○ | ○ | ○ | ○ | ○ | ○ | ○ | ○ | ○ | ○ |
| ㊼ Mirror image mode | ○ | ○ | ○ | ○ | ○ | ○ | ○ | ○ | ○ | ○ | ○ | ○ | ○ | ○ | ○ | ○ | ○ | ○ | ○ | ○ | ○ | ○ | ○ | ○ |
| ㊽ Interrupt copying | ○ | ○ | ○ | ○ | ○ | ○ | ○ | ○ | ○ | ○ | ○ | ○ | ○ | ○ | ○ | ○ | ○ | ○ | ○ | ○ | ○ | ○ | ○ | ○ |
| ㊾ Document management functions (form registration) | ○ | ○ | ○ | ○ | ○ | --- | ○ | ○ | ○ | ○ | ○ | ○ | ○ | ○ | --- | --- | --- | --- | --- | --- | --- | --- | --- | --- |
| ㊿ Document management functions (shared data box [storing documents]) | ○ | ○ | ○ | ○ | ○ | --- | ○ | ○ | ○ | ○ | ○ | ○ | ○ | ○ | --- | ○ | ○ | ○ | ○ | --- | --- | --- | --- | --- |
| 1 Document management functions (synergy print boxes [storing documents]) | ○ | ○ | ○ | ○ | ○ | ○ | ○ | ○ | ○ | ○ | ○ | ○ | ○ | ○ | --- | ○ | ○ | ○ | ○ | --- | --- | --- | --- | --- |
| 2 Document management functions (shared data box [printing out documents]) | --- | --- | --- | --- | --- | --- | --- | --- | --- | --- | --- | --- | --- | --- | ○ | --- | --- | --- | --- | --- | --- | --- | ○ | ○ |
| 3 Document management functions (synergy print boxes [printing out documents]) | --- | --- | --- | --- | --- | --- | --- | --- | --- | --- | --- | --- | --- | --- | ○ | --- | --- | --- | --- | --- | --- | --- | ○ | ○ |
| 4 Output management functions (interrupt print) | --- | --- | --- | --- | --- | --- | --- | --- | --- | --- | --- | --- | --- | --- | --- | --- | --- | --- | --- | --- | --- | --- | --- | --- |
| 5 Repeat copy mode (print out) | --- | --- | --- | --- | --- | --- | --- | --- | --- | --- | --- | --- | --- | --- | --- | --- | --- | --- | --- | --- | --- | --- | --- | --- |
| 6 Job build mode (Step 1) | ○ | ○ | ○ | ○ | ○ | ○ | ○ | ○ | ○ | ○ | ○ | ○ | ○ | ○ | ○ | ○ | ○ | ○ | ○ | ○ | ○ | ○ | ○ | ○ |
| 7 Job build mode (from step 2) | ○ | ○ | ○ | ○ | ○ | --- | ○ | ○ | ○ | ○ | ○ | ○ | ○ | ○ | ○ | ○ | ○ | ○ | ○ | ○ | ○ | ○ | ○ | ○ |
| 8 Scanner functions (Scan to PC) | ○ | --- | ○ | ○ | ○ | --- | ○ | ○ | ○ | ○ | ○ | --- | ○ | --- | --- | ○ | ○ | ○ | ○ | --- | --- | --- | --- | --- |
| 9 Scanner functions (Send E-mail) | ○ | --- | ○ | ○ | ○ | --- | ○ | ○ | ○ | ○ | ○ | --- | ○ | --- | --- | ○ | ○ | ○ | ○ | --- | --- | --- | --- | --- |
| 0 Scanner functions (TWAIN) | ○ | --- | ○ | ○ | ○ | --- | ○ | ○ | ○ | ○ | ○ | --- | ○ | --- | --- | ○ | ○ | ○ | ○ | --- | --- | --- | --- | --- |
| 1 Scanner functions (Database connection) | ○ | --- | ○ | ○ | ○ | --- | ○ | ○ | ○ | ○ | ○ | --- | ○ | --- | --- | ○ | ○ | ○ | ○ | --- | --- | --- | --- | --- |

Index

Numerics

| | |
|--------------------------|------|
| 2 in 1 | 5-13 |
| 2-sided copy modes | 5-1 |
| 4 in 1 | 5-13 |

A

| | |
|---|------|
| Accessing the copy default settings | 7-62 |
| Accessing the copy management menu screen | 7-3 |
| Accessing the machine default settings | 7-41 |
| Adjusting the copy exposure | 4-2 |
| At the end of copying | 4-4 |
| Auto clear function | 2-4 |
| Auto drawer[cassette] switching ON/OFF (machine default setting) | 7-42 |
| Auto exposure adjustment (copy default setting) | 7-73 |
| Auto exposure adjustment (OCR) (copy default setting) | 7-74 |
| Auto low power function | 4-11 |
| Auto low power time (machine default setting) | 7-48 |
| Auto magnification selection mode | 4-5 |
| Auto rotation function | 5-30 |
| Auto Rotation mode ON/OFF (copy default setting) | 7-79 |
| Auto selection mode | 8-3 |
| Auto selection/Filing mode | 8-3 |
| Auto sleep function | 4-11 |
| Auto sleep ON/OFF (machine default setting) | 7-57 |
| Auto sleep time (machine default setting) | 7-47 |
| Automatic drawer[cassette] switching function | 2-4 |

B

| | |
|---|------|
| Background exposure adjustment (copy default setting) | 7-67 |
| BASIC OPERATION | 4-1 |
| Batch scanning mode | 5-47 |
| Book erase mode | 5-11 |
| Book to Booklet mode | 5-26 |
| Booklet/Stitching mode | 5-22 |
| Border erase modes | 5-11 |
| Box management default settings | 7-94 |
| Built-in Finisher | 8-9 |

C

| | |
|--|------|
| CAUTION LABELS | 1-1 |
| Centering/Image shift mode | 5-8 |
| Changing a registered program name | 5-51 |
| Changing the copy management default settings | 7-25 |
| Changing the energy-saving mode (machine default setting) | 7-58 |
| Changing the management code (machine default setting) | 7-56 |
| Checking the copy management counts | 7-21 |
| Checking the total counter and printing out the counter report | 7-93 |
| Cleaning the copier | 10-1 |
| Cleaning the original cover | 10-1 |
| Cleaning the platen | 10-1 |
| Cleaning the separator | 10-1 |
| Cleaning the transfer roller | 10-2 |
| Combine/Merge Copy modes | 5-13 |
| COPIER MANAGEMENT | 7-1 |
| Copy default settings | 7-59 |

| | |
|--|------|
| Copy eject location (machine default setting) | 7-49 |
| Copy limit (copy default setting) | 7-82 |
| Copy management mode | 7-1 |
| Copying in the Hole Punch mode | 8-8 |
| Copying in the Sort:OFF mode | 8-6 |
| Copying in the Sort:ON mode | 8-5 |
| Copying in the Staple mode | 8-7 |
| Cover drawer[cassette] (copy default setting) | 7-71 |
| Cover mode | 5-31 |
| Custom paper type for 2-sided copying (machine default setting) | 7-46 |
| Customize screen layout (Add functions) (copy default setting) | 7-86 |
| Customize screen layout (Main functions) (copy default setting) | 7-85 |

D

| | |
|--|----------|
| Day & time (machine default setting) | 7-54 |
| Default drawer[cassette] (copy default setting) | 7-70 |
| Default magnification ratio (copy default setting) | 7-72 |
| Default operation mode (machine default setting) | 7-51 |
| Default settings | 7-38 |
| Delete department ID-codes | 7-16 |
| Deleting a registered program | 5-52 |
| Deleting a registration key | 5-55 |
| Document Finisher | 8-5, 8-9 |
| Document management functions | 6-1 |
| Document Processor | 8-1 |
| Document Tray | 8-12 |
| Drawer[Cassette] | 3-2 |
| Drum refresh | 7-91 |

E

| | |
|---|-------|
| Eco print mode | 5-48 |
| Eco print mode ON/OFF (copy default setting) | 7-66 |
| Editing copy management information | 7-4 |
| Enlarging/reducing the copy image | 4-5 |
| Entering characters | 7-104 |
| Environmental specifications | 10-9 |
| Erased border width (copy default setting) | 7-81 |
| Exposure adjustment step (copy default setting) | 7-64 |
| Exposure mode (copy default setting) | 7-63 |

F

| | |
|--|------|
| Fax eject location (machine default setting) | 7-50 |
| Fax Kit | 8-12 |
| Filing mode | 8-4 |
| Form overlay mode | 5-20 |
| Form registration | 6-1 |

H

| | |
|--|------|
| Hard Disk | 8-11 |
| Hard disk management | 7-99 |
| How to set originals in the Document Processor | 8-2 |

I

| | |
|---|-------|
| If one of the following messages is displayed | 9-1 |
| If one of these indicators lights or flashes | 9-3 |
| If other trouble occurs | 9-13 |
| Individual border erase mode | 5-12 |
| Initial mode | 2-4 |
| INSTALLATION PRECAUTIONS | 1-2 |
| Installing the optional equipment | 10-10 |
| Interrupt copying | 4-9 |
| Invert mode | 5-38 |

J

| | |
|-----------------------|------|
| Job build mode | 5-57 |
| Job reservation | 4-10 |
| Job Separator | 8-11 |

K

| | |
|-------------------|------|
| Key Counter | 8-12 |
|-------------------|------|

L

| | |
|-----------------------------------|-------|
| Language selection function | 7-103 |
| Loading paper | 3-1 |
| Low power mode | 4-11 |

M

| | |
|--|----------|
| Machine default settings | 7-38 |
| MAINTENANCE AND OPERATION INFORMATION | 10-1 |
| Making copies when copy management is turned ON | 7-37 |
| Making copy default settings | 7-63 |
| Making machine default settings | 7-42 |
| Manual exposure adjustment (photo mode) (copy default setting) | 7-77 |
| Manual exposure adjustment (text mode) (copy default setting) .. | 7-76 |
| Manual exposure adjustment (text+photo mode) (copy default setting) | 7-75 |
| Margin mode | 5-6 |
| Margin width (copy default setting) | 7-80 |
| Memo mode | 5-9 |
| Mirror image mode | 5-39 |
| Misfed in Document Finisher | 9-12 |
| Misfeed in Built-in Finisher | 9-11 |
| Misfeed in Document Processor | 9-10 |
| Misfeed in drawer[cassette] | 9-4 |
| Misfeed in left cover 1 | 9-5, 9-6 |
| Misfeed in left cover 2 | 9-7 |
| Misfeed in multi-bypass tray | 9-8 |
| Misfeed in paper feed section | 9-4 |
| Multi-bypass tray | 3-3 |
| Multi-bypass tray paper settings | 7-87 |
| Multi-bypass tray settings display ON/OFF (machine default setting) | 7-45 |

N

| | |
|----------------------|-----|
| NAMES OF PARTS | 2-1 |
|----------------------|-----|

O

| | |
|--|------|
| OPTIONAL EQUIPMENT | 8-1 |
| Original quality (copy default setting) | 7-65 |
| Original set direction | 5-49 |
| Original size registration | 7-90 |
| Original size selection | 5-34 |
| Originals that can be used with the Document Processor | 8-1 |
| Output management functions | 6-20 |

P

| | |
|--|------|
| Page separation/Split copy modes | 5-4 |
| Paper Feeder | 8-5 |
| Paper selection (copy default setting) | 7-68 |
| Paper size (drawer[cassette] No.1 - No.4) (machine default setting) | 7-43 |
| Paper type (auto paper selection mode) (copy default setting) | 7-69 |
| Paper type (drawer[cassette] No.1 - No.4) (machine default setting) | 7-44 |
| Photo mode | 4-3 |
| Precautions for the use of Document Processor | 8-1 |
| PRECAUTIONS FOR USE | 1-3 |
| Preset zoom mode | 4-7 |
| Print page numbers mode | 5-16 |
| "Print status" screen | 6-22 |
| Printer Kit | 8-12 |
| Printer/Scanner Kit | 8-12 |
| Printing out with the repeat copy mode | 5-43 |
| Program function | 5-50 |
| Proof mode | 5-40 |

R

| | |
|---|-------|
| Register new department ID-codes | 7-4 |
| Registering a copy job for repeat copying | 5-42 |
| Registering a function or mode under a function key | 5-53 |
| Registering a program | 5-50 |
| Registration keys | 5-53 |
| Registration keys ON/OFF (copy default setting) | 7-84 |
| Repeat copy mode | 5-42 |
| Repeat copying ON/OFF (copy default setting) | 7-83 |
| Report print out | 7-101 |

S

| | |
|--|--------|
| Saving on toner use | 5-48 |
| Selecting functions | 4-1 |
| Selecting the image quality | 4-3 |
| Selecting the paper size | 4-2 |
| Separate front and back margin settings | 5-6 |
| Setting an original | 4-1 |
| Setting the Key Counter | 8-12 |
| Setting the number of copies to be made | 4-3 |
| Shared data box | 6-4 |
| Sheet erase mode | 5-11 |
| Silent mode ON/OFF (machine default setting) | 7-53 |
| Sleep mode | 4-11 |
| Sort/Finished mode | 5-29 |
| Sort/Finished mode ON/OFF (copy default setting) | 7-78 |
| Special paper action setting (machine default setting) | 7-46-1 |
| Specifications | 10-7 |
| Start copying | 4-3 |
| Synergy print boxes | 6-9 |

T

| | |
|--|------|
| Text mode | 4-3 |
| Text+photo mode | 4-3 |
| Time difference (machine default setting) | 7-55 |
| Toner Container | 10-3 |
| Touch panel sound ON/OFF (machine default setting) | 7-52 |
| Transparency + backing sheet mode | 5-36 |
| Turning the copy management function ON/OFF | 7-25 |

U

| | |
|--|------|
| Using programmed settings to make copies | 5-51 |
|--|------|

W

| | |
|---------------------------|------|
| Warm-up | 4-1 |
| Waste Toner Box | 10-3 |
| When paper misfeeds | 9-4 |

X

| | |
|--------------------|-----|
| XY zoom mode | 4-8 |
|--------------------|-----|

Z

| | |
|-----------------|-----|
| Zoom mode | 4-6 |
|-----------------|-----|

*** For best copy results and machine performance, we recommend that you use only KYOCERA MITA original supplies for your KYOCERA MITA copier.**



KYOCERA MITA AMERICA, INC.

Headquarters:

225 Sand Road,
Fairfield, New Jersey 07004-0008
TEL : (973) 808-8444
FAX : (973) 882-6000

New York Branch:

1410 Broadway 23rd floor
New York, NY 10018
TEL : (917) 286-5400
FAX : (917) 286-5402

Northeastern Region:

225 Sand Road,
Fairfield, New Jersey 07004-0008
TEL : (973) 808-8444
FAX : (973) 882-4401

Midwestern Region:

201 Hansen Court Suite 119
Wood Dale, Illinois 60191
TEL : (630) 238-9982
FAX : (630) 238-9487

Western Region:

14101 Alton Parkway,
Irvine, California 92618-7006
TEL : (949) 457-9000
FAX : (949) 457-9119

Southeastern Region:

1500 Oakbrook Drive,
Norcross, Georgia 30093
TEL : (770) 729-9786
FAX : (770) 729-9873

Southwestern Region:

2825 West Story Road,
Irving, Texas 75038-5299
TEL : (972) 550-8987
FAX : (972) 570-4704

Dallas Parts Distribution Center & National Training Center:

2825 West Story Road,
Irving, Texas 75038-5299
TEL : (972) 659-0055
FAX : (972) 570-5816

KYOCERA MITA CANADA, LTD.

6120 Kestrel Road, Mississauga,
Ontario L5T 1S8, Canada
TEL : (905) 670-4425
FAX : (905) 670-8116

KYOCERA MITA MEXICO, S.A. DE C.V.

Av. 16 de Septiembre #407
Col. Santa Inés,
02130 Azcapotzalco
México, D.F. México
TEL : (55) 5383-2741
FAX : (55) 5383-7804